



Space engineering

Spacecraft charging

Foreword

This Standard is one of the series of ECSS Standards intended to be applied together for the management, engineering, product assurance and sustainability in space projects and applications. ECSS is a cooperative effort of the European Space Agency, national space agencies and European industry associations for the purpose of developing and maintaining common standards. Requirements in this Standard are defined in terms of what shall be accomplished, rather than in terms of how to organize and perform the necessary work. This allows existing organizational structures and methods to be applied where they are effective, and for the structures and methods to evolve as necessary without rewriting the standards.

This Standard has been prepared by the ECSS-E-ST-20-06C Rev.1 Working Group, reviewed by the ECSS Executive Secretariat and approved by the ECSS Technical Authority.

Disclaimer

ECSS does not provide any warranty whatsoever, whether expressed, implied, or statutory, including, but not limited to, any warranty of merchantability or fitness for a particular purpose or any warranty that the contents of the item are error-free. In no respect shall ECSS incur any liability for any damages, including, but not limited to, direct, indirect, special, or consequential damages arising out of, resulting from, or in any way connected to the use of this Standard, whether or not based upon warranty, business agreement, tort, or otherwise; whether or not injury was sustained by persons or property or otherwise; and whether or not loss was sustained from, or arose out of, the results of, the item, or any services that may be provided by ECSS.

Published by: ESA Requirements and Standards Division
ESTEC, P.O. Box 299,
2200 AG Noordwijk
The Netherlands

Copyright: 2019 © by the European Space Agency for the members of ECSS

Change log

ECSS-E-ST-20-06A	Never issued
ECSS-E-ST-20-06B	Never issued
ECSS-E-ST-20-06C 31 July 2008	First issue
ECSS-E-ST-20-06C Rev.1 15 May 2019	<p>First issue, Revision 1</p> <p>Changes with respect to ECSS-E-ST-20-06C (31 July 2008) are identified with revision tracking.</p> <p>Main changes are:</p> <p>Implementation of Change requests:</p> <ul style="list-style-type: none"> • Addition of definition for the term "flashover current" • Addition of abbreviated terms "RIC" and "SPIS" • Addition of the "Nomenclature" in clause 3.4 • Addition of informative text in 6.1.3 about neutralizers after deletion of requirement 6.7e • Changes to maximum permitted voltages and acceptance of higher voltages if the effect of worst-case ESD would be acceptable • Simplification of the grounding requirements for surface materials • Change in the permitted ESD energy where surface ESD cannot be excluded • Change to explicitly allow surface charging analysis to justify acceptance • For surface charging analysis , removal of acceptance by similarity and statement of the need for material testing • For internal charging, completely embedded floating metals may be accepted under specified conditions <p><u>Detailed changes:</u></p> <p>Added requirements:</p> <ul style="list-style-type: none"> • 6.2.1c; 6.4d and e; 6.6.3e; 6.8.1d; 6.8.2c; 7.2.2d; 9.2.2d. <p>Modified requirements:</p> <ul style="list-style-type: none"> • 6.2.1a; 6.3.1a and g; 6.3.2a and b; Figure 6-1; 6.3.3.2b; 6.3.3.4a; 6.3.3.6a and c; 6.4b and c; 6.6.1a, e, f, h; 6.6.1c (formatting only); 6.6.1k (formatting and Note 2 added).; 6.6.2b; 6.8.1b; 6.8.4a and b; 7.2.2a and c;

7.2.3.1b NOTE; 7.2.3.1c; 7.2.3.2j; 7.2.3.2m NOTE added; 7.2.3.2o; Table 7-2 Caption; 7.3a and b; 9.2.2a; 9.2.3a; 9.3c NOTE 2 added; 9.3d, e and g; 11.2.1g; 11.2.1k NOTES moved (editorial); 11.2.2a NOTE; 11.3.5a NOTE, A.1.1a (NOTES moved to end of requirement).

Deleted requirements:

- 6.3.1b, d and e; 6.7.e; 7.2.2b; 7.2.3.1c; 11.3.5b.

Editorial changes:

- Update of the Foreword to include the Branch “Sustainability”.
- Replacement of the verb “may” in the informative parts of the standard.
- Brackets in text removed in: 6.3.2c.
- Text of informative Annexes updated (editorial): B.2.1; B.2.2; B.4; B.7; C.3.9; C.4; C.5.4.3; C.5.5; C.8.4.2; C.8.4.3; C.9.4.2; C.9.6.3; D.1.16; D.2.3.

Table of contents

Change log	3
Introduction	12
1 Scope	14
2 Normative references	15
3 Terms, definitions and abbreviated terms	16
3.1 Terms defined in other standards	16
3.2 Terms specific to the present standard	16
3.3 Abbreviated terms.....	19
3.1 Nomenclature	20
4 Overview	22
4.1 Plasma interaction effects.....	22
4.1.1 Presentation.....	22
4.1.2 Most common engineering concerns.....	22
4.1.3 Overview of physical mechanisms	23
4.2 Relationship with other standards	25
5 Protection programme	27
6 Surface material requirements	28
6.1 Overview	28
6.1.1 Description and applicability.....	28
6.1.2 Purpose common to all spacecraft	29
6.1.3 A special case: scientific spacecraft with plasma measurement instruments	29
6.2 General requirements	29
6.2.1 Maximum permitted voltage	29
6.2.2 Maximum resistivity.....	30
6.3 Electrical continuity, including surfaces and structural and mechanical parts.....	31
6.3.1 Grounding of surface metallic parts.....	31
6.3.2 Exceptions	32

6.3.3	Electrical continuity for surface materials	33
6.4	Surface charging analysis.....	37
6.5	Deliberate potentials.....	38
6.6	Testing of materials and assemblies.....	38
6.6.1	General.....	38
6.6.2	Material characterization tests.....	40
6.6.3	Material and assembly qualification.....	41
6.7	Scientific spacecraft with plasma measurement instruments	42
6.8	Verification.....	42
6.8.1	Grounding.....	42
6.8.2	Material selection	43
6.8.3	Environmental effects.....	43
6.8.4	Computer modelling.....	44
6.9	Triggering of ESD.....	45
7	Secondary arc requirements	46
7.1	Description and applicability	46
7.2	Solar arrays	47
7.2.1	Overview.....	47
7.2.2	General requirement	47
7.2.3	Testing of solar arrays.....	48
7.3	Other exposed parts of the power system including solar array drive mechanisms	53
8	High voltage system requirements	54
8.1	Description	54
8.2	Requirements	54
8.3	Validation.....	55
9	Internal parts and materials requirements	56
9.1	Description	56
9.2	General.....	56
9.2.1	Internal charging and discharge effects.....	56
9.2.2	Grounding and connectivity.....	57
9.2.3	Dielectric electric fields and voltages.....	57
9.3	Validation.....	59
10	Tether requirements	63
10.1	Description	63
10.2	General.....	63

10.2.1	Hazards arising on tethered spacecraft due to voltages generated by conductive tethers	63
10.2.2	Current collection and resulting problems	63
10.2.3	Hazards arising from high currents flowing through the tether and spacecraft structures.....	64
10.2.4	Continuity of insulation.....	64
10.2.5	Hazards from undesired conductive paths	64
10.2.6	Hazards from electro-dynamic tether oscillations	64
10.2.7	Other effects	65
10.3	Validation.....	65
11	Electric propulsion requirements	67
11.1	Overview	67
11.1.1	Description.....	67
11.1.2	Coverage of the requirements.....	67
11.2	General.....	69
11.2.1	Spacecraft neutralization.....	69
11.2.2	Beam neutralization	71
11.2.3	Contamination.....	71
11.2.4	Sputtering	72
11.2.5	Neutral gas effects	72
11.3	Validation.....	72
11.3.1	Ground testing	72
11.3.2	Computer modelling characteristics	73
11.3.3	In-flight monitoring.....	73
11.3.4	Sputtering	73
11.3.5	Neutral gas effects	74
Annex A	(normative) Electrical hazard mitigation plan - DRD.....	75
A.1	DRD identification.....	75
A.1.1	Requirement identification and source document.....	75
A.1.2	Purpose and objective.....	75
A.2	Expected response	75
A.2.1	Scope and content	75
A.2.2	Special remarks	76
Annex B	(informative) Tailoring guidelines.....	77
B.1	Overview	77
B.2	LEO.....	77
B.2.1	General.....	77

B.2.2	LEO orbits with high inclination	78
B.3	MEO and GEO orbits.....	78
B.4	Spacecraft with onboard plasma detectors	78
B.5	Tethered spacecraft.....	79
B.6	Active spacecraft	79
B.7	Solar Wind.....	79
B.8	Other planetary magnetospheres.....	79
Annex C (informative)	Physical background to the requirements	80
C.1	Introduction.....	80
C.2	Definition of symbols.....	80
C.3	Electrostatic sheaths.....	80
C.3.1	Introduction	80
C.3.2	The electrostatic potential	81
C.3.3	The Debye length.....	81
C.3.4	Presheath	82
C.3.5	Models of current through the sheath.....	83
C.3.6	Thin sheath – space-charge-limited model.....	83
C.3.7	Thick sheath – orbit motion limited (OML) model	84
C.3.8	General case.....	85
C.3.9	Magnetic field modification of charging currents.....	85
C.4	Current collection and grounding to the plasma	85
C.5	External surface charging	86
C.5.1	Definition.....	86
C.5.2	Processes	86
C.5.3	Effects.....	87
C.5.4	Surface emission processes	87
C.5.5	Floating potential.....	88
C.5.6	Conductivity and resistivity.....	89
C.5.7	Time scales.....	91
C.6	Spacecraft motion effects	91
C.6.1	Wakes.....	91
C.6.2	Motion across the magnetic field	94
C.7	Induced plasmas	95
C.7.1	Definition.....	95
C.7.2	Electric propulsion thrusters	96
C.7.3	Induced plasma characteristics	96
C.7.4	Charge-exchange effects	97

C.7.5	Neutral particle effects	98
C.7.6	Effect on floating potential	98
C.8	Internal and deep-dielectric charging	98
C.8.1	Definition	98
C.8.2	Relationship to surface charging	99
C.8.3	Charge deposition	100
C.8.4	Material conductivity	100
C.8.5	Time dependence	103
C.8.6	Geometric considerations	103
C.8.7	Isolated internal conductors	104
C.8.8	Electric field sensitive systems	104
C.9	Discharges and transients	105
C.9.1	General definition	105
C.9.2	Review of the process	105
C.9.3	Dielectric material discharge	106
C.9.4	Metallic discharge	108
C.9.5	Internal dielectric discharge	109
C.9.6	Secondary powered discharge	110
C.9.7	Discharge thresholds	110
Annex D (informative) Charging simulation	112	
D.1	Surface charging codes	112
D.1.1	Introduction	112
D.2	Internal charging codes	114
D.2.1	DICTAT	114
D.2.2	ESADDC	114
D.2.3	GEANT-4	115
D.2.4	NOVICE	115
D.3	Environment model for internal charging	115
D.3.1	FLUMIC	115
D.3.2	Worst case GEO spectrum	115
Annex E (informative) Testing and measurement.	116	
E.1	Definition of symbols	116
E.2	Solar array testing	116
E.2.1	Solar cell sample	116
E.2.2	Pre-testing of the solar array simulator (SAS)	117
E.2.3	Solar array test procedure	119
E.2.4	Other elements	123

E.2.5	The solar panel simulation device	124
E.3	Measurement of conductivity and resistivity	125
E.3.1	Determination of intrinsic bulk conductivity by direct measurement	125
E.3.2	Determination of radiation-induced conductivity coefficients by direct measurement	127
E.3.3	Determination of conductivity and radiation-induced conductivity by electron irradiation.....	128
E.3.4	The ASTM method for measurement of surface resistivity and its adaptation for space used materials.....	128

References 130

Bibliography..... 134

Figures

Figure 6-1:	Applicability of electrical continuity requirements	34
Figure 7-1:	Solar array test set-up	51
Figure C-1 :	Schematic diagram of potential variation through sheath and pre-sheath.	82
Figure C-2 :	Example secondary yield curve	88
Figure C-3 :	Schematic diagram of wake structure around an object at relative motion with respect to a plasma.....	92
Figure C-4 :	Schematic diagram of void region.....	93
Figure C-5 :	Schematic diagram of internal charging in a planar dielectric.....	99
Figure C-6 :	Dielectric discharge mechanism.	107
Figure C-7 :	Shape of the current in relation to discharge starting point.....	107
Figure C-8 :	Example of discharge on pierced aluminized Teflon® irradiated by electrons with energies ranging from 0 to 220 keV.	108
Figure C-9 :	Schematic diagram of discharge at a triple point in the inverted voltage gradient configuration with potential contours indicated by colour scale.	109
Figure E-1 :	Photograph of solar cells sample – Front face & Rear face (Stentor Sample. Picture from Denis Payan - CNES®).....	117
Figure E-2 :	Schematic diagram of power supply test circuit.....	118
Figure E-3 :	Example of a measured power source switch response.....	118
Figure E-4 :	Example solar array simulator.....	119
Figure E-5 :	Absolute capacitance of the satellite	120
Figure E-6 :	Junction capacitance of a cell versus to voltage.....	122
Figure E-7 :	The shortened solar array sample and the missing capacitances	123
Figure E-8 :	Discharging circuit oscillations	124
Figure E-9 :	Effect of an added resistance in the discharging circuit (SAS + resistance)	124
Figure E-10 :	Setup simulating the satellite including flashover current	125

Figure E-11 : Basic arrangement of apparatus for measuring dielectric conductivity in planar samples.....	126
Figure E-12 : Arrangement for measuring cable dielectric conductivity and cross-section through co-axial cable.....	126
Figure E-13 : Arrangement for carrying out conductivity tests on planar samples under irradiation	127
Figure E-14 : Basic experimental set up for surface conductivity	129

Tables

Table 4-1: List of electrostatic and other plasma interaction effects on space systems.....	24
Table 7-1: Tested voltage-current combinations	47
Table 7-2: Typical inductance per unit length for cables	52
Table C-1 : Parameters in different regions in space	82
Table C-2 : Typical plasma parameters for LEO and GEO	93
Table C-3 : Plasma conditions on exit plane of several electric propulsion thrusters	97
Table C-4 : Emission versus backflow current magnitudes for several electric propulsion thrusters.....	97
Table C-5 : Value of E_a for several materials	101

Introduction

The subject of spacecraft plasma interactions has been part of the spacecraft design process since spacecraft surface charging was first encountered as a problem in the earliest geostationary spacecraft. However, spacecraft surface charging is only one of the ways in which the space environment can adversely affect the electrical state of spacecraft and satellite technology has evolved over the years.

A need was identified for a standard that is up to date and comprehensive in its treatment of all the main environment-induced plasma and charging processes that can affect the performance of satellites in geostationary and medium and low Earth orbits. This standard is intended to be used by a number of users, with their own design rules, and therefore it has been done to be compatible with different alternative approaches.

This document aims to satisfy these needs and provides a consistent standard that can be used in design specifications. The requirements are based on the best current understanding of the processes involved and are not radical, building on existing de-facto standards in many cases.

As well as providing requirements, it aims to provide a straightforward brief explanation of the main effects so that interested parties at all stages of the design chain can have a common understanding of the problems faced and the meaning of the terms used. Guide for tailoring of the provisions for specific mission types are described in Annex B. Further description of the main processes are given in Annex C. Some techniques of simulation, testing and measurement are described in Annex D and Annex E.

Electrical interactions between the space environment and a spacecraft can arise from a number of external sources including the ambient plasma, radiation, electrical and magnetic fields and sunlight. The nature of these interactions and the environment itself can be modified by emissions from the spacecraft itself, e.g. electric propulsion, plasma contactors, secondary emission and photoemission. The consequences, in terms of hazards to spacecraft systems depend strongly on the sensitivity of electronic systems and the potential for coupling between sources of electrical transients and fields and electronic components.

Proper assessment of the effects of these processes is part of the system engineering process as defined in ECSS-E-ST-20. General assessments are performed in the early phases of a mission when consideration is given to e.g. orbit selection, mass budget, thermal protection, and materials and component selection policy. Further into the design of a spacecraft, careful consideration is given to material selection, coatings, radiation shielding and electronics protection.

This standard begins with an overview of the electrical effects occurring in space (Clause 4). The requirements, in terms of spacecraft testing, analysis and design that arise from these processes (Clause 5 to Clause 11) form the core of this document. Annex B holds a discussion of types of orbits and how to tailor the requirements according to the mission. Annex C discusses the quantitative assessment of the physical processes behind these main effects. Annex D describes computer simulations and Annex E describes testing and measurement.

1 Scope

This standard is a standard within the ECSS hierarchy. It forms part of the electrical and electronic engineering discipline (ECSS-E-ST-20) of the engineering branch of the ECSS system (ECSS-E). It provides clear and consistent provisions to the application of measures to assess, in order to avoid and minimize hazardous effects arising from spacecraft charging and other environmental effects on a spacecraft's electrical behaviour.

This standard is applicable to any type of spacecraft including launchers, when above the atmosphere.

Although spacecraft systems are clearly subject to electrical interactions while still on Earth (e.g. lightning and static electricity from handling), these aspects are not covered, since they are common to terrestrial systems and covered elsewhere. Instead this standard covers electrical effects occurring in space (i.e. from the ionosphere upwards).

This standard may be tailored for the specific characteristic and constraints of a space project in conformance with ECSS-S-ST-00.

2

Normative references

The following normative documents contain provisions which, through reference in this text, constitute provisions of this ECSS Standard. For dated references, subsequent amendments to, or revision of any of these publications do not apply. However, parties to agreements based on this ECSS Standard are encouraged to investigate the possibility of applying the more recent editions of the normative documents indicated below. For undated references, the latest edition of the publication referred to applies.

ECSS-S-ST-00-01

ECSS system - Glossary of terms

3

Terms, definitions and abbreviated terms

3.1 Terms defined in other standards

For the purpose of this Standard, the terms and definitions from ECSS-S-ST-00-01 apply.

3.2 Terms specific to the present standard

3.2.1 aluminium equivalent thickness

thickness of aluminium with a mass density per unit area equal to that of the material being described

NOTE The mass density is normally measured in (g cm^{-2}).

3.2.2 auroral zone

region at a latitude between 60 and 70 degrees north or south where aurorae are formed

3.2.3 deep-dielectric charging

electrical charge deposition within the bulk of an external or internal material

3.2.4 dielectric

pertaining to a medium in which an electric field can be maintained

NOTE Depending on their resistivity, dielectric materials can be described as insulating, antistatic, moderately conductive or conductive. The following gives a classic example of classification according to the resistivity:

- more than $10^9 \Omega \text{ m}$: insulating
- between $10^2 \Omega \text{ m}$ and $10^9 \Omega \text{ m}$: antistatic
- between $10^3 \Omega \text{ m}$ and $10^6 \Omega \text{ m}$: static dissipative
- between $10^{-2} \Omega \text{ m}$ and $10^2 \Omega \text{ m}$: moderately conductive
- less than $10^{-2} \Omega \text{ m}$: conductive

3.2.5 dose

energy absorbed locally per unit mass as a result of **radiation** exposure

3.2.6 downstream

<relating to an object at relative motion with respect to a **plasma**>
on side of an object in the same direction as the **plasma** velocity vector

3.2.7 electrostatic

pertaining to static electricity or electricity at rest

3.2.8 electrostatic breakdown

failure of the insulation properties of a **dielectric**, resulting in a sudden release of charge and risk of damage to the **dielectric** concerned

3.2.9 electrostatic discharge

rapid, spontaneous transfer of electrical charge induced by a high **electrostatic** field

3.2.10 external charging

electric charge deposition on external materials

3.2.11 flashover current

current arising from a surface propagating discharge

3.2.12 fluence

time-integration of the flux

3.2.13 insulator

insulating **dielectric**

3.2.14 internal charging

electrical charge deposition on internal materials shielded at least by the spacecraft skin due to penetration of charged particles from the ambient medium

NOTE Materials can be conductors or dielectrics.

3.2.15 internal dielectric charging

internal charging of **dielectric** materials

3.2.16 ion engine

propulsion system which operates by expelling ions at high velocities

3.2.17 L shell

parameter of the geomagnetic field

NOTE 1 It is also referred as L, and is used as a co-ordinate to describe positions in near-Earth space.

NOTE 2 L or L shell has a complicated derivation based on an invariant of the motion of charged particles in the terrestrial magnetic field. However, it is useful in defining plasma regimes within the magnetosphere because, for a dipole magnetic field, it is equal to the geocentric altitude in Earth-radii of the local magnetic field line where it crosses the equator.

3.2.18 omnidirectional flux

scalar integral of the flux over all directions

NOTE This implies that no consideration is taken of the directional distribution of the particles which can be non-isotropic. The flux at a point is the number of particles crossing a sphere of unit cross-sectional surface area (i.e. of radius). An omnidirectional flux is not to be confused with an isotropic flux.

3.2.19 outgassing rate

mass of molecular species evolving from a material per unit time and unit surface area

NOTE The units of outgassing rates are $\text{g cm}^{-2} \text{s}^{-1}$. It can also be given in other units, such as in relative mass unit per time unit: (g s^{-1}), ($\% \text{s}^{-1}$) or ($\% \text{s}^{-1} \text{cm}^{-2}$).

3.2.20 plasma

partly or wholly ionized gas whose particles exhibit collective behaviour through its electromagnetic field

3.2.21 primary discharge

initial electrostatic discharge which, by creating a temporary conductive path, can lead to a secondary arc

3.2.22 radiation

transfer of energy by means of a particle (including photons)

NOTE In the context of this Standard, electromagnetic radiation below the UV band is excluded. This therefore excludes visible, thermal, microwave and radio-wave radiation.

3.2.23 radiation belt

area of trapped or quasi-trapped energetic particles, contained by the Earth's magnetic field

3.2.24 ram

volume adjacent to the spacecraft and located in the same direction of the spacecraft motion where modification to the surface or **plasma** can occur due to the passage of the spacecraft through the medium

3.2.25 secondary arc

passage of current from an external source, such as a solar array, through a conductive path initially generated by a **primary discharge**

3.2.26 surface charging

electrical charge deposition on the surface of an external or internal material

3.2.27 tether

flexible conductive or non-conductive cable linking two spacecraft or two parts of the same spacecraft not mechanically attached in any other way

3.2.28 thruster

device for altering the attitude or orbit of a spacecraft in space through reaction

NOTE E.g. rocket, cold-gas emitter, and electric propulsion.

3.2.29 triple point

<relating to onset of electrostatic discharge>
point where **dielectric**, metal and vacuum meet

3.2.30 upstream

<relating to an object at relative motion with respect to a **plasma**>
on the side of the object in the opposite direction to the **plasma** velocity vector

3.2.31 wake

volume adjacent to a spacecraft and located in the opposite direction to the spacecraft motion where the ambient **plasma** is modified by the passage of the spacecraft through the medium

3.3 Abbreviated terms

The following abbreviated terms are defined and used within this Standard.

Abbreviation	Meaning
AOCS	attitude and orbital control system
DGD	direct gradient discharge
EMC	electromagnetic compatibility
emf	electro-motive force
EP	electric propulsion
ESD	electrostatic discharge
ETFE	ethylene-tetrafluoroethylene copolymer
eV	electron volt (also keV, MeV)
FEEP	field emission electric propulsion
FEP	fluoroethylene-propylene

GEO	geostationary Earth orbit
HEO	highly eccentric orbit
ISS	International Space Station
IVG	inverted voltage gradient
IVGD	inverted voltage gradient discharge
LEO	low Earth orbit
MEMS	micro-electromechanical system(s)
MEO	medium (altitude) Earth orbit
MLI	multi-layer insulation
MLT	magnetic local time
NASA	National Aeronautics and Space Administration
NGD	normal gradient discharge
PCB	printed circuit board
PEO	polar Earth orbit
PTFE	poly-tetrafluoroethylene
PVA	photo-voltaic assembly
RIC	radiation induced conductivity
r.m.s.	root-mean-square
SAS	solar array simulator
SPIS	spacecraft plasma interaction simulation
SPT	stationary plasma thruster
SSM	second surface mirror
UV	ultra-violet light

3.1 Nomenclature

The following nomenclature applies throughout this document:

- a. The word “shall” is used in this Standard to express requirements. All the requirements are expressed with the word “shall”.
- b. The word “should” is used in this Standard to express recommendations. All the recommendations are expressed with the word “should”.

NOTE It is expected that, during tailoring, recommendations in this document are either converted into requirements or tailored out.

- c. The words “may” and “need not” are used in this Standard to express positive and negative permissions, respectively. All the positive permissions are expressed with the word “may”. All the negative permissions are expressed with the words “need not”.
- d. The word “can” is used in this Standard to express capabilities or possibilities, and therefore, if not accompanied by one of the previous words, it implies descriptive text.

NOTE In ECSS “may” and “can” have completely different meanings: “may” is normative (permission), and “can” is descriptive.

- e. The present and past tenses are used in this Standard to express statements of fact, and therefore they imply descriptive text.

4

Overview

4.1 Plasma interaction effects

4.1.1 Presentation

Most spacecraft engineers have come across the term space plasma because of the potential risk it represents in leading to high-level spacecraft charging and related electrostatic discharges. Such a phenomenon is a critical environment hazards for satellites, especially in high altitude orbits (including in geostationary orbit). However, there are numerous other plasma interaction effects of which it is also important to be aware, in order to improve engineering design and to optimize the behaviour of space systems in the space plasma environment. Not all spacecraft-plasma interactions are adverse. For example, electrodynamic tethers use current collection from the plasma to complete their electrical circuit and generate power or thrust. Scientific instruments **can** exploit spacecraft plasma interactions to make plasma measurements, and a magnetospheric propulsion system has been proposed to use plasma interactions with an artificial magnetic field as a propulsion system.

This clause briefly introduces the various effects covered by this standard. The most common engineering issues are first briefly described in clause 4.1.2 while a short overview of the physical mechanisms involved is given in the second of this section.

4.1.2 Most common engineering concerns

The following are the most common engineering concerns related to electrical charging of a spacecraft:

- **Surface charging** due to charge accumulation on spacecraft surface is a potential cause of spacecraft anomalies. High levels of differential potential **can** lead to ESDs which **can** couple to spacecraft electronics and damage electronic components. Initial ESDs **can** also trigger the generation of secondary arcs on high voltage systems. Several occurrences of permanent solar array power loss in space are believed to be related to such phenomena.
- **Internal charging** due to penetrating electrons is another cause of spacecraft anomalies. ESDs **can** be generated within the spacecraft Faraday cage and in close proximity to vulnerable components.

- **Current leakage** affects exposed high voltage systems which can experience significant power loss due to current leakage sustained by freely moving particles (from the plasma or photo-electrons).
- **Environment modification** occurs as a bi-product of surface charging and/or particle emission by surfaces. Electric charge and plasma density are affected in a volume that can extend very far from the spacecraft (many times its typical dimension). This is usually a critical problem for scientific plasma measurements that cannot retrieve the natural parameters to be measured without taking these alterations into account.
- **Electric propulsion** actively modifies the local environment and creates a local plasma population and modifies the current balance of the satellite that otherwise can occur. It can affect other spacecraft systems, e.g. by increased contamination.
- **Electrostatic tethers** make use of current collection from the ambient medium to allow a current to pass. These also change the currents passing through the system and can lead to high potentials.

Table 4-1 contains a more complete list of the various effects in which space plasma plays an important role.

A quantitative description of the most important processes in spacecraft-plasma interactions is given in Annex C but a brief qualitative overview follows here.

4.1.3 Overview of physical mechanisms

Surface charging occurs because electric charges (electrons and ions) of the plasma are free to move and eventually get trapped on material surfaces when they hit them. Electrons and ions provide negative and positive current respectively. Both electrons and ions can also expel electrons when they hit the surface, providing an additional positive current. UV and soft X-ray photons coming from the Sun also have enough energy to expel electrons from materials, thereby providing a positive current. The accumulation of charge (positive or negative) leads to the creation of a potential that eventually prevents further charge accumulation by repelling charges of a given polarity and attracting charges of opposite polarity. Different surfaces on the same spacecraft can charge to very different potentials, resulting in strong local electric fields. Photo-emission and secondary yield are important factors in determining occurrence of high level differential charging. Charging effect is highly dynamic as the plasma populations can change rapidly.

Internal charging occurs because higher energy electrons are able to penetrate thin surfaces and deposit charge in or on materials within the spacecraft. Internal charging involves lower currents but potentials can build up over longer periods on materials with low resistivity because current through the structure is the only mechanism by which charge can be removed. Strong electric fields again are the result.

An important hazard related to charging (surface and internal) is sudden electrostatic discharge (ESD). ESDs are most likely initiated by field effect emission and avalanche process at so-called 'triple-points', where metal, dielectric and vacuum are found together. This can eventually result in the injection of high current electrical transients into the spacecraft electrical

system. This can cause transient state changes in electronics or permanent damage of material coating or electronic components. In the vicinity of high potential differences, plasma released in an ESD can trigger a secondary discharge or even a sustained arc if the potential is maintained e.g. by the solar array.

Table 4-1: List of electrostatic and other plasma interaction effects on space systems

Spacecraft reference potential change (e.g. so-called spacecraft high voltage charging)
Differential surface charging
Internal surface charging
Deep-dielectric charging
Surface charging effects on e.g. plasma instruments
Charging interactions with thruster plumes
Charging induced sputtering
Charging induced contamination
Dust charging and sticking
Electrostatic sticking (SA, inflatables, solar sails, dusts)
Charging differences in docking procedures and EVA
Material modifications (e.g. electric field induced conductivity, plasma-contaminant modifications, cracking e.g. of ITO)
Tether systems and $v \times B$ induced voltages and currents
Interference induced by electrostatic sheath and induced plasma on EM systems
Spontaneous discharges
Triggered discharges: <ul style="list-style-type: none"> - Thruster-triggered - Low voltage discharges (e.g. Paschen and secondaries) - Sunlit/shadow triggered discharges - triggered by micro particles - triggered by natural high density plasma
Synergistic secondary low-voltage discharges (e.g. on solar array)
Power loss and current flow from exposed elevated voltage systems
Photoelectron cloud induced charging and disturbance of plasma sensors
Plasma perturbation from microparticle impacts (e.g. antennas)
Active plasma sources (e.g. emitters, thrusters, contactors)

If a surface is maintained at high potential, it draws a current from the plasma, particularly in the dense LEO environment. This is an issue with exposed solar array interconnects because this leakage current drains power from the array. In addition the floating potential of the spacecraft can be altered as a result.

The magnitude of spacecraft plasma interaction effects varies greatly with the changes in the ambient plasma from one type of Earth orbit to another. Also the plasma environment can exhibit temporal changes along the orbit and as a result of so-called 'Space Weather'. In addition, the spacecraft itself can modify the plasma environment e.g. via thruster firings, active experiments, or debris impacts. Other aspects of the space environment besides plasma can also influence the plasma interaction e.g. radiation, contamination, and temperature.

In any case, it is important to have access to a good quantitative description of the space environment. Suitable descriptions and models of the space environment, including aspects that control charging effects, can be found in ECSS-E-ST-10-04.

4.2 Relationship with other standards

This standard is a standard within the engineering branch. It relies on the following ECSS standards:

ECSS-E-ST-10 "Space engineering – System engineering general requirements"

ECSS-E-ST-20 "Space engineering - Electrical and electronic"

A number of ECSS standards are related to this Standard:

- The environment, defined by ECSS-E-ST-10-04 "Space engineering - Space environment", is an input to the analysis of charging and related effects described in this document.
- Radiation transport as described in ECSS-E-ST-10-12 "Space engineering - Method for the calculation of radiation received and its effects, and a policy for design margins" has relevance to internal charging effects described in this document.
- Secondary electron emission is a feature of surface charging effects described in this document and in multipaction as described in ECSS-E-ST-20-01 "Space engineering – Multipaction design and test".
- Testing of electrostatic behaviour shares many techniques with general electromagnetic cleanliness. Hence ECSS-E-ST-20-07 "Space engineering – Electromagnetic compatibility" interfaces with this standard.
- Charging of solar arrays is an important charging hazard. Hence ECSS-E-ST-20-08 "Space engineering – Photovoltaic assemblies and components" interfaces with this standard.
- This standard specifies the selection of materials and components according to their electrical behaviour, in order to avoid hazardous effects. Electrical properties are not the only consideration and ECSS-Q-ST-70-71 "Space product assurance - Data for selection of space materials and processes" describe complementary information.
- ECSS-E-ST-10-02 "Space engineering – Verification" specifies the concepts behind verification processes in general, the criteria for defining a verification strategy and rules for its implementation. It includes a description of the documentation associated to the verification process, and provisions on specific aspects of the verification process.

- ECSS-E-ST-10-03 “Space engineering – Testing” gives standard environmental and performance test requirements for a space system and its constituents. It defines the general test requirements for products and systems that are generally applicable to all projects. It also defines the documentation associated with testing activities.

5 Protection programme

ECSS-E-ST-20-06_0070001

- a. For any spacecraft, the supplier shall establish, at the start of the project, a plan for the assessment and mitigation of hazards associated with electrical interactions with the environment in conformance with Annex A.

ECSS-E-ST-20-06_0070002

- b. The compliance of the design with the design requirements shall be verified through measurement, inspection and testing.

6

Surface material requirements

6.1 Overview

6.1.1 Description and applicability

The phenomenon of surface charging leads to requirements to control the electrical behaviour of materials directly in contact with the ambient plasma. These materials can become the source of electrostatic discharges whose principal hazardous effect is to cause damage to electronic systems elsewhere on the spacecraft and of undesired electric fields, whose principal effect is to interfere with measurements of the ambient medium. The components affected include any spacecraft material on the outer surface of the spacecraft, e.g. thermal blankets, solar cell cover glass, sensor optics, exposed cables.

In addition, thin films, e.g. thermal blankets, sometimes do not shield underlying materials from the electrons mainly responsible for high level surface charging (~ 10 keV to 50 keV). Hence components affected include any spacecraft material covered by only a thin film, with thickness equivalent to less than 100 micro-meters Aluminium (0,03 g/cm²), including multi-layer insulation. The requirements in this clause also apply to surfaces partly exposed to space through small apertures (e.g., venting holes), although holes can be designed so as to avoid direct exposure.

Another factor influencing charging levels is the conduction path from each surface to ground and to other parts on the spacecraft. Hence these requirements cover all components concerned with the grounding and electrical continuity of the spacecraft structure, subsystems and electronics.

In addition to considering components that affect the build-up of charge, the effects of any resulting electrostatic discharges, i.e. coupling to sensitive devices, are controlled in order to prevent discharges causing damage and interference to systems elsewhere. This is an EMC issue that is common to electrical transients, however generated. Because this is part of general EMC design, specific requirements are not included here but standard EMC procedures are applied to control the transmission of transients.

These requirements also cover solar arrays and there are additional specific requirements for these due to the possibility of secondary discharges, fed by the power of the array itself, in clause 7.

6.1.2 Purpose common to all spacecraft

The main purpose of the requirements in this clause is to reduce differential charging and therefore the risk of electrostatic discharge or its power below an acceptable level. This is achieved principally by effective grounding throughout the spacecraft.

6.1.3 A special case: scientific spacecraft with plasma measurement instruments

Scientific spacecraft, which have the measurement of ambient electric field or of low energy particles as part of their mission, have more stringent requirements in terms of differential charging, absolute spacecraft potentials and contamination by spacecraft generated particles. For this reason, clause 6.7 provides specific requirements for this case.

Since quantitative requirements are often mission specific, the requirements in clause 6.7 are not intended to be exhaustive, but to cover the common aspects that can be expected in most of the scientific missions.

For each science mission the scientific community assesses the need for a neutralizer (ion or electron emitter) is used to mitigate the positive or negative floating potential of the spacecraft. This device can be supplied as part of the scientific payload or included in the supplier contract.

Plasma contactors are generally avoided on scientific spacecraft because of the large scale disturbance they induce on scientific measurements.

In practice the reduction of photo-electron and secondary electron emission is often achievable by active potential control techniques only.

6.2 General requirements

6.2.1 Maximum permitted voltage

ECSS-E-ST-20-06_0070003

- a. In order to avoid electrostatic discharge, the following critical voltages and electric fields shall be used:
 1. To avoid electrostatic discharges, a maximum electric field within the dielectric of 10^7 V/m.
 2. To avoid electrostatic discharges in normal potential gradient a maximum differential voltage between a dielectric and an adjacent conductor of -2000 V.
 3. To avoid an electrostatic discharge in inverted voltage gradient, a maximum differential voltage between a dielectric and an adjacent conductor exposed to the vacuum of +300 V.

NOTE 1 Maximum permitted voltages specified for scientific missions including field or plasma

measurement can be lower than the limits above to limit contamination of environmental measurements.

NOTE 2 An inverted voltage gradient is between a dielectric and a conductor at a more negative potential.

NOTE 3 A normal voltage gradient is between a dielectric and a conductor at a more positive potential.

NOTE 4 These voltage limits do not include margin for the possible inaccuracy of analysis by simulation.

NOTE 5 Electric fields can be locally enhanced by sharp edges.

ECSS-E-ST-20-06_0070004

- b. If the limits specified in 6.2.1a are not met, the assembly shall be submitted to charging tests as described in clause 6.6.
- c. The test specified in requirement 6.2.1b may be replaced by an ESD analysis under the condition that the ESD responsible agrees that the result of this analysis demonstrate that the effect of such a worst-case ESD is acceptable.

6.2.2 Maximum resistivity

ECSS-E-ST-20-06_0070005

- a. In order to limit differential voltage, a maximum current density of $J = 10 \text{ nA/cm}^2$ through the dielectric shall be used to calculate the maximum resistivity of dielectric materials.

NOTE This current is a recommended upper bound of the current through dielectric material to other parts on Earth orbiting spacecraft. It is not the electron irradiation current used for testing.. For example, a small sunlit area of aluminium coupled to a larger area of material in eclipse can lead to a current flow through a dielectric beneath the aluminium as large as the photocurrents ($\sim 4 \text{ nA/cm}^2$ for aluminium) plus any difference in secondary emission current.

ECSS-E-ST-20-06_0070006

- b. The method used for resistivity measurement shall be justified.

NOTE Some methods are described in Annex D.3.

6.3 Electrical continuity, including surfaces and structural and mechanical parts

6.3.1 Grounding of surface metallic parts

ECSS-E-ST-20-06_0070007

- a. To prevent ESD events, all structural and mechanical parts shall be electrically bonded to each other, ensuring that, in order to control differential charging, there is a resistance of less than $10^6 \Omega$ at each bond.

NOTE 1 For example, for electrical boxes.

NOTE 2 EMC requirements can be more restrictive than this.

For EMC requirements, see ECSS-E-ST-20-07.

ECSS-E-ST-20-06_0070008

- b. <<deleted>>

ECSS-E-ST-20-06_0070009

- c. Where structural ground is carried across slip-rings on a rotating joint, at least two slip-rings shall be dedicated to the structural ground path, some at each end of the slip-ring set.

NOTE This is to provide redundancy.

ECSS-E-ST-20-06_0070010

- d. <<deleted>>

ECSS-E-ST-20-06_0070011

- e. <<deleted>>

ECSS-E-ST-20-06_0070012

- f. Circuits and conductive elements shall remain grounded in all possible situations

NOTE E.g. contacts and cables in switched circuits and moveable conductors.

ECSS-E-ST-20-06_0070013

- g. The grounding of surface conductors shall be implemented in one of the following two ways:

1. Make the grounding to the main spacecraft of external and internal metallic parts and intrinsically conductive parts, like carbon, by a resistance of a value that satisfies requirement in clause 4.2.11 of ECSS-E-ST-20-07.

2. Select the resistance to spacecraft ground not to be exceeded, such that it ensures that metal parts do not float by over V_{MAX} absolute potential with respect to spacecraft ground as specified in requirement 6.2.1a.

NOTE This normally leads to a requirement that the product of the resistance R and the area exposed to the environment A , is such that

$$R \cdot A \leq \frac{V_{MAX}}{J}$$

For a V_{MAX} of 300 V and $J = 10 \text{ nA cm}^{-2}$,

$$RA \leq 1 \times 10^6 \text{ } \Omega \text{ m}^2$$

For example:

- For a one square metre MLI, the maximum resistance is 3 M Ω
- For a scientific mission where $V_{MAX}=10 \text{ V}$,
 $RA \leq 10^5 \text{ } \Omega \text{ m}^2$

6.3.2 Exceptions

ECSS-E-ST-20-06_0070166

- a. Except in the case specified in 6.3.2c, floating conductive parts may be used if they have an area less than 1 cm² and have a total capacitance less than 50 pF with respect to the structure and not be part of a multi-conductor elements structure and are more than 20 mm away from a power line.

NOTE 1 This is to limit the energy available to discharge.

NOTE 2 Multi-conductor structures exist where at least two conductive elements are separated by a dielectric surface of less than 100 cm².

ECSS-E-ST-20-06_0070015

- b. The configuration shall be such that energy involved in any possible discharge is less than one corresponding to a discharge of a capacitance of 50 pF under $6 \times 10^3 \text{ V}$.

ECSS-E-ST-20-06_0070016

- c. In case of multiple elements, in which case the empirical rule in 6.3.2a does not apply, tests shall be performed.

NOTE 1 Examples are patched antenna and solar arrays are multiple elements.

NOTE 2 See 6.3.1d NOTE for definition of a multi-conductor structures.

6.3.3 Electrical continuity for surface materials

6.3.3.1 Applicability

ECSS-E-ST-20-06_0070017

- a. The applicability of the electrical continuity requirements shall be established in accordance with the diagram in Figure 6-1.



- (a) Surfaces partially exposed include those exposed through small apertures such as venting holes.
- (b) Multi-conductor structures exist where at least two conductive elements are separated by a dielectric surface of less than 100 cm².
- (c) A capacitance of less than 50 pF is typically the case where the surface area is less than 1 cm². Keeping the capacitance low limits the size of any discharge. In LEO the short charging time as the spacecraft crosses the aurora limits the size of discharge even with a capacitor up to 100 pF.
- (d) Two dielectric patches within a 100 cm² area are considered as one single dielectric for area or width estimates.
- (e) This forms a triple point. For the definition of "triple point" see clause 3.2. An example where this is important is the spot of non-conductive glue used to stick wires near the ends of an array string from the bare ends.

ECSS-E-ST-20-06_0070164

Figure 6-1: Applicability of electrical continuity requirements

6.3.3.2 General

ECSS-E-ST-20-06_0070018

- a. All spacecraft surface materials shall be conductive to the extent that they lead to surface voltage below the maximum voltage specified in clause 6.2.1.

ECSS-E-ST-20-06_0070019

- b. If a surface material is used which is not conductive, to the extent specified in 6.3.3.2a, then it shall be [verified by testing or appropriate charging analysis in accordance with clause 6.4](#), whether hazardous charging can occur [under representative worst case conditions](#).

ECSS-E-ST-20-06_0070020

- c. The determination of dc resistance of the surface material shall include the change over the service life of the bond in the environmental conditions which it is expected to experience including vacuum, temperature and mechanical stress.

6.3.3.3 Blankets

ECSS-E-ST-20-06_0070021

- a. All external and internal metallic layers of a thermal blanket shall be grounded to the structure with at least 2 bonding straps directly to ground (no daisy chain configuration).

ECSS-E-ST-20-06_0070022

- b. Any point on a blanket shall be within 1 m of a bonding strap.

ECSS-E-ST-20-06_0070023

- c. Adjacent blankets greater than 100 cm² in area shall be separately grounded to structure.

6.3.3.4 Material assemblies

ECSS-E-ST-20-06_0070024

- a. Material assemblies composed of different materials that are not separately grounded, shall be [analysed or tested](#) in their entirety.

[NOTE 1](#) An example is optical solar reflectors.

[NOTE 2](#) A complicated assembly, e.g. with high number of different layers, or not well represented by dielectrics coating planar surfaces, can be difficult to simulate in the analysis tools and then testing is needed in accordance with this requirement.

ECSS-E-ST-20-06_0070025

- b. Metallic layers within material assemblies shall not be exposed to the plasma.

6.3.3.5 Conductive coatings**ECSS-E-ST-20-06_0070026**

- a. The thickness of conductive coatings shall be such that there is no degradation of their performance as a conductor when exposed to the expected erosion due to sputtering and atomic oxygen.

6.3.3.6 Dielectric materials**ECSS-E-ST-20-06_0070027**

- a. The following materials shall **not be used unless it can be demonstrated by charging analysis with a proper 3D computation tool that they pose no threat to the spacecraft**:
1. Perforated metallized FEP or ETFE (SSM)
 2. Polyimide material with thickness above 50 μm if no ESD conductive coating is used on the space-exposed side
 3. FEP, ETFE, C_2F_4
 4. Epoxy glass
 5. Silica cloth

NOTE The reason is that they have a known association with ESD risks.

ECSS-E-ST-20-06_0070028

- b. For dielectric materials, laid on top of a more conductive material, the resistivity of the dielectric shall be such that the electric field anywhere within the dielectric does not exceed $E_{\text{MAX}} = 10^7$ V/m.

NOTE Normally, this is fulfilled through the requirement that the resistivity is less than the ratio of E_{MAX} by the current density J .

$$r \leq \frac{E_{\text{MAX}}}{J}$$

For a J of 10 nA cm^{-2} , $r \leq 10^{11}$ $\Omega \text{ m}$.

ECSS-E-ST-20-06_0070029

- c. For a dielectric material, adjacent to a more conductive material and both exposed to vacuum, hereby constituting a triple point, the resistivity of the dielectric shall be such that the dielectric does not charge at any location to more than 2 kV negative or to more than 300 V positive with respect to the adjacent conductor.

NOTE 1 Normally, for a slab geometry, this is fulfilled through the requirement that the resistivity r is such that

$$r \leq \frac{1}{t} \frac{V_{MAX}}{J}$$

or

$$r \leq \frac{t}{d^2} \frac{V_{MAX}}{J}$$

where t is the material thickness and d is the minimum distance at the surface of the dielectric to the adjacent grounded conductor.

or

$$\rho \leq \frac{V_{MAX}}{J} \frac{2}{d^2}$$

where ρ is surface resistivity in Ω /square.

NOTE 2 The first equation in NOTE 1 is when the main conduction path is through the thickness of the material, e.g., to an underlying conductor while the second and third equations are when the main conduction path is parallel to the surface, e.g. to an adjacent conductor.

For a V_{MAX} of 100 V and J of 10 nA cm⁻², $V_{MAX} / J = 10^6 \Omega \text{ m}^2$.

For example, a 100 μm thickness dielectric must have a resistivity of less than $10^{10} \Omega \cdot \text{m}$ if on top of a conductor and a resistivity of less than $10^6 \Omega \cdot \text{m}$ if on top of a very resistive material and grounded every 1 cm.

For a scientific mission where, say $V_{MAX}=10\text{V}$, $V_{MAX} / J = 10^4 \Omega \text{ m}^2$ usually implies that all surface materials must be good conductors.

NOTE 3 No margin is included in the values in NOTE 2.

6.4 Surface charging analysis

ECSS-E-ST-20-06_0070030

- a. A surface charging analysis shall be performed, including:
 1. A systematic inventory of all surface materials, their resistivity, area and thickness.
 2. A systematic inventory of triple-points, floating conductors and multiple-conductor element components.

ECSS-E-ST-20-06_0070031

- b. In the event that some dielectric surfaces are left more insulating than specified in 6.3.3.6, requirements in 6.3.3.2 shall be verified by [3D surface charging analysis](#).

ECSS-E-ST-20-06_0070032

- c. Computational modelling [at spacecraft scale](#) shall [emulate](#) the effects of the phenomenon related to surface particle emission, secondary emission and photo-emission, conduction and collection processes.

NOTE 1 Annex D describes some charging codes that can form part of this analysis.

NOTE 2 Many materials suitable for space use are found in ECSS-Q-ST-70-71.

- d. [In case the material parameters needed for 6.4c are not known and cannot be extracted from a material database accepted by the customer, testing shall be performed to obtain the data.](#)
- e. [The charging analysis may consist of an SPIS analysis.](#)

6.5 Deliberate potentials

ECSS-E-ST-20-06_0070033

- a. The perturbation of surface electrostatic potential arising from potentials that are deliberately maintained on a surface shall be analysed.

NOTE This can for example be the case where a scientific experiment has a deliberately exposed surface held at a potential. Recessing and shielding of the potential surface are strategies for reducing such perturbations.

6.6 Testing of materials and assemblies

6.6.1 General

ECSS-E-ST-20-06_0070034

- a. If the requirements of 6.3.3 and 6.4 are not satisfied, tests shall be performed on a representative sample of the concerned surface material or assembly.

ECSS-E-ST-20-06_0070035

- b. The rationale behind the test, the details of the procedure and the test results shall be submitted to the customer for approval.

ECSS-E-ST-20-06_0070036

- c. The tests shall either:
1. reproduce the physical process of concern, i.e. charging, in a worst-case environment, or
 2. yield electrostatic material properties enabling the materials response to such an environment to be assessed.

ECSS-E-ST-20-06_0070037

- d. The tests shall be performed under vacuum (i.e. < 1 mPa) and electron irradiation.

ECSS-E-ST-20-06_0070038

- e. The tests shall be performed after outgassing of the material [under vacuum](#).

NOTE Changes to material conductivity can occur as volatile substances are lost by outgassing.

ECSS-E-ST-20-06_0070039

- f. [In cases in which the effect of dose-rate and dose is determined by test, it shall be performed](#) via irradiation by electrons that have energy sufficient to pass right through the sample.

ECSS-E-ST-20-06_0070040

- g. A mono-energetic spectrum with energy from 20 keV to 40 keV shall be used to deliver the surface charging current.

ECSS-E-ST-20-06_0070041

- h. The flux intensity [applied to the samples under test shall be adapted to realistic rate of charging as experienced in orbit](#).

NOTE For GEO testing it is generally 250 pA/cm² for low energy electrons (0 to 50) keV and (0,1 to 50) pA/cm² for high-energy electrons (400 keV).

ECSS-E-ST-20-06_0070042

- i. For LEO, the current shall be delivered in pulses representative of auroral crossing durations, typically 2 minutes for circular LEO orbits with inclination above 50°.

ECSS-E-ST-20-06_0070043

- j. Tests shall be performed at temperature of use in space.

NOTE This is because temperature has a large effect on conductivity in dielectric materials. As temperature falls, resistivity rises.

ECSS-E-ST-20-06_0070044

- k. Qualification tests for materials shall:
1. be performed with multi-energetic electron beams, and
 2. reproduce the dose-rate and charging current of the environment.

NOTE 1 This is because of the radiation and electric field induced conductivity. These effects influence the surface voltage and consequently the risk of discharge.

NOTE 2 Reproduce ageing effect due to high energetic electron irradiation of the environment corresponding to the entire life in orbit.

ECSS-E-ST-20-06_0070045

1. The number of samples to be tested shall be agreed with the customer.

NOTE Because of microscopic differences between samples, several samples are normally tested to allow for sample variability.

6.6.2 Material characterization tests

ECSS-E-ST-20-06_0070167

- a. A material characterization test need not be performed for a material, if it is only used in assemblies for which tests have been performed at assembly level.

ECSS-E-ST-20-06_0070047

- b. Except in the case specified in 6.6.2a, each new non-conductive material that has never flown on a spacecraft shall be tested under realistic irradiation conditions in terms of electron spectrum and across the temperature range to be used, to prove that there is no ESD risk **unless test results under similar conditions are available**.

ECSS-E-ST-20-06_0070048

- c. Materials shall be tested separately in order to evaluate electrostatic risk through knowledge of their electrical properties, including:
 1. bulk (intrinsic) conductivity,
 2. surface conductivity,
 3. radiation-induced conductivity,
 4. relative permittivity, and
 5. discharge threshold level

ECSS-E-ST-20-06_0070049

- d. The minimum size of the sample under test shall be above 30 mm × 30 mm.

NOTE A good quality measurement of the surface voltage can be made with this size.

ECSS-E-ST-20-06_0070050

- e. Sample thickness and physical properties shall be representative of flight configuration.

6.6.3 Material and assembly qualification

ECSS-E-ST-20-06_0070051

- a. Tests shall be performed for both normal voltage and inverted voltage situations.

ECSS-E-ST-20-06_0070052

- b. It shall be agreed with the customer whether or not inverted voltage situation is simulated through potential biasing.

ECSS-E-ST-20-06_0070053

- c. The assembly testing under the worst case environment at all temperatures to be used in the mission shall lead to an assessment of ESD risk as follows:
1. No ESD is observed and potential remains below 100 V in inverted gradient or 1000 V in direct gradient: No ESD risk.
 2. No ESD is observed but potential between 100 V and 1000 V in inverted voltage gradient or potential above 1000 V in normal gradient mode under multi-energetic irradiation: moderate ESD risk.
 3. ESD is observed: high ESD risk.

NOTE Definition of the worst-case environment is part of the customer specification and can refer to the ECSS-E-ST-10-04 "Space environment".

ECSS-E-ST-20-06_0070054

- d. In the cases 6.6.3c.2 and 6.6.3c.3, a determination of the possible effects of ESDs on electronic systems shall be performed by analysis and testing.
- e. Assemblies shall be tested with a bonding to ground that is representative of the flight configuration.

6.7 Scientific spacecraft with plasma measurement instruments

ECSS-E-ST-20-06_0070055

- a. Surface materials shall be conductive to reduce differential charging over the spacecraft surface to a value to be agreed with the customer.

NOTE This value is mission dependent, and normally about 10 V.

ECSS-E-ST-20-06_0070056

- b. Secondary electron and photo-electron currents originating from surfaces shall be kept to a fraction of the expected natural electron flux at detector exposed surfaces, agreed with the customer.

NOTE This fraction is mission dependent and is normally 10 %.

ECSS-E-ST-20-06_0070057

- c. The floating potential of the particle detector entrance and of neighbouring surfaces shall be analysed.

ECSS-E-ST-20-06_0070058

- d. The effect of elevated voltage systems and of the spacecraft motion through the ambient magnetic field shall be analysed.

NOTE An example is for solar array.

ECSS-E-ST-20-06_0070059

- e. <<deleted>>

6.8 Verification

6.8.1 Grounding

ECSS-E-ST-20-06_0070060

- a. Electrical continuity and grounding shall be verified by inspection and testing.

ECSS-E-ST-20-06_0070061

- b. The DC resistance shall be measured and documented during [integration and agreed by the ESD responsible](#).

NOTE 1 Generally the ESD responsible is determining where resistivity measurements are made, specifying it beforehand and as a feedback loop.

NOTE 2 See also ECSS-E-ST-20-07 clause 4.2.11 " Electrical bonding requirements".

ECSS-E-ST-20-06_0070062

- c. A final check of the ground system continuity shall be performed during preparation for space vehicle launch.
- d. Any modifications prior to launch shall respect the grounding requirements and be confirmed by a measurement of continuity.

6.8.2 Material selection

ECSS-E-ST-20-06_0070063

- a. Material parameters shall be ascertained through testing, either by the manufacturer or as part of the selection procedure.

NOTE Examples are bulk conductivity and surface conductivity.

ECSS-E-ST-20-06_0070064

- b. Conductivity shall be determined by test according to a standard to be agreed with the customer.

NOTE See IEC 93 [28] or ASTM-D257 [29] and Annex E.3.1

- c. For material parameters where a test was not performed, the values intended to be used shall be submitted for customer approval.

NOTE Similarity of one material to another is difficult to ascertain without testing. It is not a good practice to rely on extrapolation from other materials in charging simulations.

6.8.3 Environmental effects

ECSS-E-ST-20-06_0070065

- a. It shall be demonstrated that the continuity of current paths is not compromised by environmental effects, including
 1. mechanical effects (vibration, shocks and depressurization),
 2. thermal changes, and
 3. surface erosion.

6.8.4 Computer modelling

ECSS-E-ST-20-06_0070066

- a. Where analysis through computer modelling is part of the acceptance procedure, the analysis shall include the following effects:
1. primary electron and ion currents,
 2. secondary emission,
 3. photo-emission and back-scattered particle currents, and
 4. conductivities.

NOTE Conductivities include bulk, surface, RIC, delayed RIC, and photo-induced conductivity.

ECSS-E-ST-20-06_0070067

- b. SEE characteristics shall be taken from customer recognized material databases, or if not available derived from ad-hoc studies, taking into account the evolution of characteristics over the mission lifetime.

NOTE SEE characteristics can sometimes be found in relevant literature.

ECSS-E-ST-20-06_0070068

- c. A spacecraft design shall not be validated by simulation alone but by the continuity and control of surface materials described in clause 6.3.3.

NOTE This is due to unmonitored changes to material characteristics that can occur in flight.

ECSS-E-ST-20-06_0070069

- d. The simulation and testing to be used as part of the validation procedure for non compliant materials and assembly to demonstrate the requirements on charging, shall be agreed with the customer.

ECSS-E-ST-20-06_0070070

- e. If assessment of the electric fields and space charge density in a large volume is performed, the 3-D spacecraft charging codes to be used shall be defined.

NOTE These 3-D spacecraft charging codes can consider the detailed geometry of the spacecraft. Various charging codes with different complexity are available for performing the assessment (see Annex C).

6.9 Triggering of ESD

ECSS-E-ST-20-06_0070071

- a. The density of neutral gas density around a spacecraft due to neutral gas emission shall be analysed and an assessment made of the risk of the triggering of discharges by the gas.

NOTE 1 The reason is that ESDs can be triggered on charged surfaces at potentials below the level at which they would normally occur due to the emission of neutral gases e.g. from chemical or electric propulsion systems.

NOTE 2 An example is during thruster firings.

7

Secondary arc requirements

7.1 Description and applicability

Secondary arcs are described as non-sustained when the arc duration is shorter than the primary discharge, including flashover current, and are described as self-sustained when the arc lasts longer than the primary discharge. A self-sustained arc is described as temporary if it stops even though power is still available, or permanent if it does not stop while external power is still available.

Secondary arcs, fed from power sources on the spacecraft, are an important additional damage mechanism since the power source can become permanently short-circuited. Systems affected include solar arrays and associated power lines, power slip rings of solar array driving mechanisms, electrical propulsion power units and motors, and high-voltage power supplies of travelling wave tubes.

- Requirements for solar arrays are presented in clause 7.2, and they apply to any photovoltaic generator including substrates, coverglasses and interconnexions. The purpose of these design requirements is to avoid self-sustained secondary arc occurrence and its effect on solar panels and to prevent degradation from primary ESD's. These are in addition to the provisions relating to surface charging in clause 6.

Specific requirement on testing of solar arrays are presented in clause 7.2.3. In general testing is always performed for solar arrays because the surface charging requirements are not fulfilled (typically at GEO). In addition to the surface charging testing described in clause 6.6, the testing requirements presented in 7.2.3, associated with controlling sustained arcs, apply to solar arrays.

Tests have been performed which proved that no sustained arcs can be established for the design of Silicon and GaAs solar array coupon investigated in EMAGS 2 study [39] when the maximum voltage-current couple available between two adjacent cells on the panel, separated with 0,9 mm as nominal value, is below the voltage and current thresholds given in the first two columns of Table 7-1.

The voltage is the maximum voltage between two adjacent cells, taking into account possible over-voltage. The current is the maximum current that can flow through a conductive part of the array (usually the current of a single string if each is protected by a diode). The cell separation is the nominal cell separation and assumes a 20 % variation about this value.

- Requirements for solar array drive motors are presented in clause 7.3, and apply to the electric motors, gearing, control electronics and drive systems used to maintain solar array orientation.

Table 7-1: Tested voltage-current combinations

Voltage	Current	Comments
70 V	0,6 A	No self sustained secondary arcing observed
50 V	1,5 A	No self sustained secondary arcing observed
30 V	2 A	No self sustained secondary arcing observed
10 V	No requirements	Voltage is too low to allow any arcing between non pure electrodes

7.2 Solar arrays

7.2.1 Overview

Solar array requirements are in addition to those surface continuity whose applicability is described in Figure 6-1.

7.2.2 General requirement

ECSS-E-ST-20-06_0070072

- a. If the design of the solar arrays does not fulfil clause 6.3, then all the following shall be done:
1. perform an analysis of the ESD characteristics, and
 2. perform an EMC test to qualify the solar array at the expected discharge levels, unless the discharge levels are already covered by the projects EMC/ESD test requirements.

NOTE 1 EMC test specifications can originate in ISO 14302 or ECSS-E-ST-20-07.

NOTE 2 ESD characteristics can originate in ECSS-E-HB-20-06.

ECSS-E-ST-20-06_0070073

- b. <<deleted>>
- c. The test specification to perform the test required in requirement 7.2.2a.2 shall be provided for customer approval.
- d. In case suitable test data of the same solar arrays with the same or higher I and V , from previous missions is available, these data may be used without further testing.

7.2.3 Testing of solar arrays

7.2.3.1 General

ECSS-E-ST-20-06_0070168

- a. Secondary arc testing of solar arrays may be omitted for solar arrays with voltage less than or equal to 10 V.

ECSS-E-ST-20-06_0070075

- b. Testing of solar arrays shall demonstrate that the plasma created by a primary ESD or resulting from another triggering mechanism does not lead to a self sustained secondary arc and does not lead to the degradation of the solar array.

NOTE 1 Examples are:

- Potential triggering mechanisms are primary ESDs, hypervelocity impacts, thruster firings and other plasma sources.
- Possible degradation of solar arrays are contamination, loss of insulation, and cell degradation

NOTE 2 Risk assessment of by-pass diode degradation is covered by a specific EMC immunity test to ESD effects.

ECSS-E-ST-20-06_0070076

- c. <<deleted>>

ECSS-E-ST-20-06_0070077

- d. A series of tests shall be performed with the inter-connector covered with an insulator to observe discharges in solar cell assembly (SCA) gaps areas.

ECSS-E-ST-20-06_0070078

- e. The test duration shall be such as to allow at least 10 discharges in each area.

7.2.3.2 Test characteristics:

ECSS-E-ST-20-06_0070079

- a. Testing shall be performed on solar array coupons.

NOTE See also 7.2.3.2h.

ECSS-E-ST-20-06_0070080

- b. The test shall be performed using inverted voltage gradient conditions.

NOTE An IVG configuration can be obtained by using keV electron beams or filament vaporization or neutralized or non neutralized ion source (cf reference [39]).

ECSS-E-ST-20-06_0070169

- c. Any method of creating the initial conductive path to trigger a secondary arc may be used if all the available current can flow through this path.

NOTE 1 Example methods are primary discharge from electron irradiation, low energy neutral plasma or laser pulse.

NOTE 2 The reason that the trigger method is not important is that objective of the test is not to demonstrate that secondary arcs do not occur but to demonstrate that they do not cause damage.

ECSS-E-ST-20-06_0070082

- d. If a low energy plasma (temperature of the order of 1 eV or less) is used to initiate the ESD, the inverted voltage gradient is obtained using plasma instead of vacuum in the chamber and the tests shall be modified as follows:

1. Modify the absolute capacitances representing the satellite capacitance and solar array capacitance in order to keep the same energy for the primary discharge, since the discharge voltage is lower.
2. Verify that the plasma path impedance does not prevent all the available charge to be discharged.

NOTE The duration of the primary discharge is still a research topic as it seems to be a function of the whole solar panel area. So far the longest observed duration is 100 μ s for a 1 m² solar panel.

ECSS-E-ST-20-06_0070083

- e. Testing shall take place under vacuum in a test chamber with the following characteristics:

1. vacuum in the chamber: around 10⁻⁴ Pa;
2. a power supply (solar array simulator) capable of reproducing the dynamic response of the array to transient short-circuits;
3. high voltage cable feed-throughs (up to 5 kV) to be connected to the power supply and the coupons;
4. non-interacting surface potential recorders 0 kV to 20 kV for x-(y) scanning (if electron beam test is used);
5. simultaneous ESD current transient monitoring and recording;

6. visual observation, photography, and video recording of the test sample during the test;
7. high voltage power supplies (around -5 kV);
8. trigger method for generating initial conductive path e.g. keV energy electron gun (e.g. 8 keV) or ion source (at least 10^{11} m⁻² s⁻¹ and 1 eV).

ECSS-E-ST-20-06_0070084

- f. The test coupon shall be a flight-representative qualification coupon.

ECSS-E-ST-20-06_0070085

- g. Tests shall be performed for the most severe voltage for each gap size existing on the solar array depending on section operation modes.

ECSS-E-ST-20-06_0070086

- h. The features of the test coupon shall include the following:
 1. 2 strings of 2 cells in series bonded head to tail as a minimum.
 2. Solar cell string-to-string connections opened up and each string rewired so that the ends of each string can be connected separately at the connector.
 3. The gap between the adjacent strings set to the minimum design gap.
 4. By-pass diodes connected, including end diode, if it exists.

ECSS-E-ST-20-06_0070087

- i. When blocking diodes are used, their recovery time shall be less than 100 ns.

ECSS-E-ST-20-06_0070088

- j. **With** the cells not illuminated **the** available current and capacitance shall be simulated by power sources and external capacitors C_{SAT} and C_{SA} representing the satellite and solar array capacitances as shown in Figure 7-1.

NOTE When occurring spontaneously in space, a primary discharge arises from the discharge of the various capacitances on the solar array. A typical order of magnitude of the total capacitance is 200 pF to 500 pF on a GEO spacecraft under 3 kV (around 1 μ C or 1 mJ).

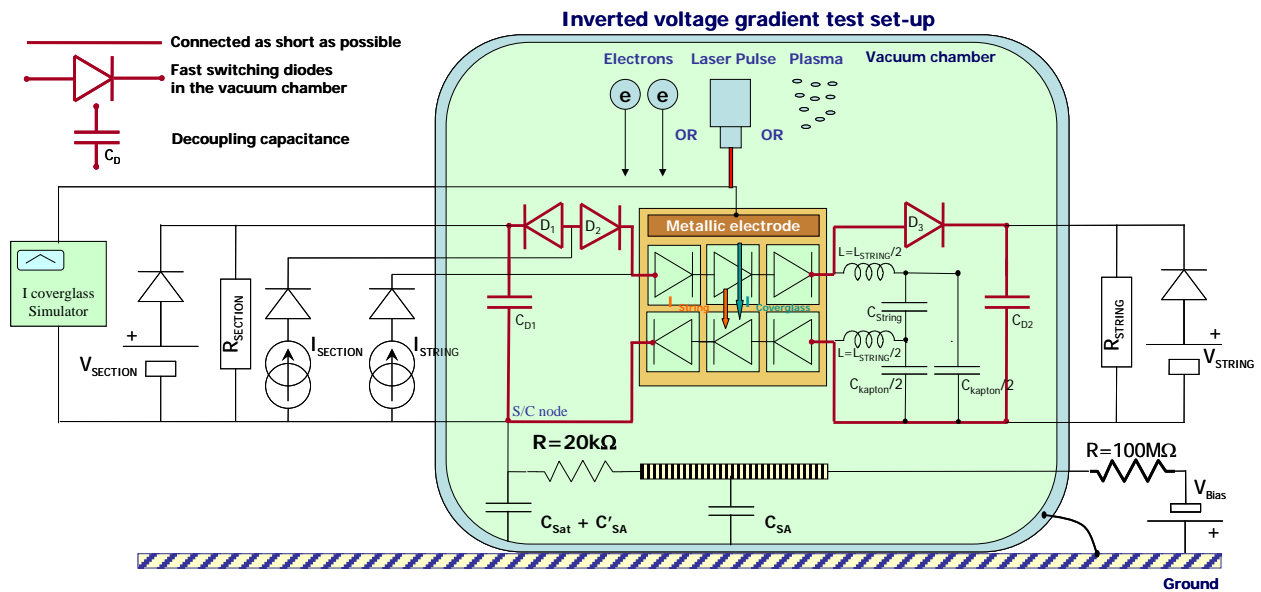

ECSS-E-ST-20-06_0070165

Figure 7-1: Solar array test set-up

ECSS-E-ST-20-06_0070089

- k. Cells shall be polarized during the test when the discharge occurs.

ECSS-E-ST-20-06_0070090

- l. Before testing, it shall be verified that cells diodes are conductive.

NOTE This can be done by passing a small current through the string. This current is usually taken to be about 10 mA (to avoid unrealistic heating).

ECSS-E-ST-20-06_0070091

- m. The capacitance of the missing cover glasses shall be included in the test.

NOTE Information on how to simulate cover glasses can be found in:

- V. Inguibert et al. 2013 [49]
- A. Gerhard et al. 2015 [50]

ECSS-E-ST-20-06_0070092

- n. All the energy stored in the various capacitances and the power delivered by the SAS shall be available within 500 ns.

NOTE At 10^4 m/s the plasma bubble reaches the opposite side of an intercell gap in less than 100 ns. A discharge (in the inverted voltage case) lasts some microseconds. The reason of the requirement is that the deadline for the establishment of the nominal current is much lower than the discharge

duration, i.e. around 1 μ s. The set-up presented in Figure 7-1 allows a rise time below 1 μ s because the wire length (red circuit) can be easily less than 1 m.

ECSS-E-ST-20-06_0070093

- o. The inductance of the test circuit shall be controlled as follows:
1. If only a part of the nominal current is flowing through the cells:
 - (a) The remaining SAS power from the current source is available during the duration of the primary discharge,
 - (b) the SAS inductance, L_{SAS} , and the wire length lead to an inductance equivalent to the string inductance.
 2. If the nominal string current is already flowing through the diodes cells, **no specification on L_{SAS} and the wire length is necessary.**

NOTE 1 Current below the nominal current can be used to polarize the cells when in the inverted voltage gradient conditions, to avoid heating the cells or when there are no blocking diodes and to simulate the whole section.

NOTE 2 $\tau = \frac{L}{R}$,

where τ is the discharge duration, L is the inductance which is proportional to the wire length and R is the arc resistance. If we choose 1 Ω for R to include all the potential cases, we obtain $\tau = L$. For a length of two metres, it takes 2 μ s to obtain the nominal current. As it is in practice very difficult to reduce the length between samples in the vacuum chamber and the external power source, twisted power wires or coaxial cables can be used to reduce the inductance. This allows a longer distance between power supply and the solar array sample.

Typical values of inductance are given in Table 7-2.

Table 7-2: Typical inductance per unit length for cables

Type	Inductance
Simple wire	2 μ H/m input and return
Twisted wires	1 μ H/m
Coaxial line	down to 0,25 μ H/m

7.2.3.3 Test criteria

ECSS-E-ST-20-06_0070094

- a. Testing shall not be considered successful unless:
1. no sustained arc occurs, and
 2. the insulation between cell strings is not degraded, and
 3. the insulation between the solar cell network and the solar panel structure is not degraded.

NOTE Further details of examples of test procedures for solar array simulators are described in Annex E.

7.3 Other exposed parts of the power system including solar array drive mechanisms

ECSS-E-ST-20-06_0070095

- a. Requirements for solar arrays in 7.2 shall apply to all exposed parts of a power system, except that
1. blocking diodes at each end of string **are not used**, and
 2. the power supply **is** adapted to reproduce the current that could be available to the discharge.

ECSS-E-ST-20-06_0070096

- b. Testing requirements for solar arrays in 7.2.3 shall apply **to** all exposed parts of a power system **with a test set-up including representative inductance and capacitance and taking into account dielectric aging due to dose**.

NOTE The objective is to demonstrate that secondary arcing due to any kind of primary phenomenon cannot lead to damage.

ECSS-E-ST-20-06_0070097

- c. Requirements on high voltage systems in clause 8 shall apply all exposed parts of a power system.

8

High voltage system requirements

8.1 Description

These requirements are directed mainly at solar arrays in the LEO environment. However, they can also be applicable to exposed surfaces held at high potential e.g. for scientific purposes. When using high voltage (>150 V) equipment, there is a risk of self-sustained Townsend discharge in the event of a pressure increase.

8.2 Requirements

ECSS-E-ST-20-06_0070098

- a. It shall be demonstrated that that no self-sustained discharge can occur in any on-board equipment.

NOTE This is generally achieved by insulating high voltage parts.

ECSS-E-ST-20-06_0070099

- b. For low Earth orbits when using high voltage solar arrays (above 150 V), it shall be demonstrated that the expected power losses when the solar array is surrounded by a cold and dense plasma is equal or less to a percentage loss agreed with the customer.

NOTE Losses are generally limited to a few percent or less.

ECSS-E-ST-20-06_0070100

- c. An analysis shall be performed to determine the potential effect of the grounding of the solar array with respect to the spacecraft on the floating potential of the spacecraft.

8.3 Validation

ECSS-E-ST-20-06_0070101

- a. Validation of power loss shall be performed by analysis of current passing through the plasma.

NOTE An example is with a computational tool or by laboratory simulation.

9

Internal parts and materials requirements

9.1 Description

This clause presents both the general and the validation ESD requirements for internal parts and materials.

- General ESD requirements for internal parts presented in 9.2 concern any dielectric (or isolated conductor-dielectric combination), potentially subject to electrostatic breakdown, for example:
 - cable insulation;
 - printed circuit boards;
 - integrated circuit packaging;
 - ungrounded spot shielding;
 - optical elements.

In addition parts include any internal system sensitive to electric fields and comprising insulators or isolated conductors, for example:

- triaxial accelerometers;
- microelectromechanical systems (MEMS).
- ESD requirements for validation of internal parts and materials presented in 9.3 are provided to ensure that mitigation against hazardous levels of internal charging are put into effect.

9.2 General

9.2.1 Internal charging and discharge effects

ECSS-E-ST-20-06_0070102

- a. Internal charging and subsequent discharge effects shall be assessed early in the spacecraft design cycle (project Phase B).

9.2.2 Grounding and connectivity

ECSS-E-ST-20-06_0070103

- a. All metallic components shall be supplied with **two separated** grounding paths.

NOTE This requirement includes structural elements, spot shielding, transformer cores, metal packaging of components, unused tracks on PCBs etc. Also included are cables used for testing on the ground but unused in orbit and cables that become temporarily isolated through the operation of a relay, e.g. antenna feeds when in redundant mode.

ECSS-E-ST-20-06_0070104

- b. Conductive paths shall have a resistance to ground of less than $10^{12} \Omega$.

ECSS-E-ST-20-06_0070170

- c. Cables running external to the main spacecraft body, should have the minimum thickness of dielectric insulation consistent with their primary function.

NOTE This arises from the general rule that higher electric fields can arise in thicker dielectrics.

- d. Floating metals may be used if they and their underlying dielectric together receive less than $0,02 \text{ pA/cm}^2$ or they are completely embedded so that the metal is not exposed to the vacuum.

NOTE 1 In certain cases, some risks can remain even with electron integral current below $0,02 \text{ pA/cm}^2$ depending on the geometry and thickness of insulating parts and on the electron environment spectrum in orbit, especially for a dynamic environment.

NOTE 2 This is because there are no triple points and therefore a discharge is only possible by breakdown of the dielectric. Hence the critical current related to dielectric discharges is applied.

9.2.3 Dielectric electric fields and voltages

ECSS-E-ST-20-06_0070106

- a. Unless it is demonstrated that the material, in the situation in which it is used, is capable to sustain a higher bulk field without ESD, electric fields within dielectric materials shall be kept **within the limits defined in requirement 6.2.1a**.

NOTE 1 The objective is to minimize the occurrence of discharges due to internal dielectric charging.

NOTE 2 The default value does not contain a safety margin. It is usual for a project specification to define an additional margin, depending on the mission and the approach to risk.

ECSS-E-ST-20-06_0070107

- b. The electric field within dielectric materials shall be computed by simulation, or measured by test.

NOTE Particle transport simulation or ray-tracing can form part of the computer simulation.

ECSS-E-ST-20-06_0070108

- c. Voltages on internal surfaces shall be kept below the maximum voltage limits described in 6.2.1.

NOTE The objective is to minimize the occurrence of internal surface discharges on surfaces not exposed to the ambient plasma but accessible by penetrating electrons.

ECSS-E-ST-20-06_0070109

- d. The voltages on internal surfaces shall be computed by simulation, or measured by test.

NOTE Particle transport simulation or ray-tracing could form part of the computer simulation.

ECSS-E-ST-20-06_0070110

- e. For analysis and testing, a customer-agreed worst-case environment shall be used, in the form of either:
1. a worst-case model of radiation belt electron fluxes in conjunction with an orbit generator, or
 2. a worst-case spectrum for the orbit in question

NOTE 1 A worst case spectrum for internal charging is a time-average where the time period reflects the time-scale of internal charging (usually 1 day).

NOTE 2 The FLUMIC electron environment model (see Annex D.3) has been created specifically for internal charging assessments for all terrestrial orbits.

NOTE 3 Electron environment models which are averages of periods much longer than a day are used in assessments of other processes, e.g. dose analysis, but are inappropriate for internal charging analysis.

ECSS-E-ST-20-06_0070111

- f. For systems sensitive to absolute levels of internal electric fields and comprising insulators or isolated conductors, electric fields induced by internal charging shall be assessed in the design phase (project Phase C).

NOTE Examples are MEMS and triaxial accelerometers.

ECSS-E-ST-20-06_0070112

- g. The electric fields in systems sensitive to absolute levels of internal electric fields shall stay within the levels agreed with the customer.

NOTE 1 The acceptability of field levels depends on the application.

NOTE 2 The electric field can be controlled through radiation shielding of sensitive areas, grounding or controlled discharge strategies.

9.3 Validation

ECSS-E-ST-20-06_0070113

- a. Inspection of the spacecraft (including structure and cable harnesses) shall be performed to verify that there are no ungrounded metal components.

ECSS-E-ST-20-06_0070114

- b. Resistance testing shall be carried out on grounded metal components to ensure that their grounding meet the requirements in 9.2.2.

ECSS-E-ST-20-06_0070115

- c. Testing of circuits shall be performed at equipment level by the application of voltage spikes on input, output and power lines.

NOTE 1 This determines whether filtering is adequate.

NOTE 2 A suggested test method is given in ISO 14302:2002 clause A.3.2.8.2 "Plasma/payload-induced differential charging/discharges".

ECSS-E-ST-20-06_0070116

- d. Bulk conductivity characteristics shall:
1. apply to the lowest temperature to be used, and
 2. use a measurement technique agreed with the customer, and
 3. be taken from customer recognized databases, or derived from ad-hoc studies.

NOTE 1 The objective is to use a technique appropriate to internal charging. Annex E.3 provides some examples of such measurement techniques.

NOTE 2 It is good practice to be careful in the use of bulk conductivity characteristics from literature. The measurements in some open literature and company specifications can be inappropriate in calculations of internal charging electric fields. Such measurements are usually made at room temperature and before time-dependent polarization effects have died away. This usually gives an apparent conductivity that is far higher than the longer-term conductivity which is relevant for internal charging.

ECSS-E-ST-20-06_0070171

- e. Computer simulation of electric fields or irradiation testing within a dielectric may be omitted if one of the following three criteria is satisfied:
1. The charging current density j deposited in the material, after radiation shielding, is lower than the maximum electric field, multiplied by a worst case conductivity σ_{\min} , i.e. $j < E_{\max} \sigma_{\min}$.
 2. The part is shielded such that currents under worst-case natural environments are too low to cause hazardous levels of charging, based on the current density described in 9.3e.1.
 3. The bulk conductivity, at the lowest temperature at which it is intended to be used, is equivalent to or higher than the following ones for a radiation shielding of $0,2 \text{ g cm}^{-2}$:
 - (a) For GEO, $2,5 \times 10^{-15} \Omega^{-1} \text{ m}^{-1}$.
 - (b) In any other case, $2,5 \times 10^{-14} \Omega^{-1} \text{ m}^{-1}$.

NOTE 1 These conductivities prevent the creation of high electrical fields, and are calculated using j from the FLUMIC environment model given in Annex D.3.1.

NOTE 2 If one of the above criteria is met, it is an indication that problems with high electric fields are very unlikely. These criteria are based on the formula linking electric field E with current density j and conductivity σ , $E = j/\sigma$. This formula arises from Ohm's law.

ECSS-E-ST-20-06_0070118

- f. In satisfying 9.3e, the minimum value of dielectric conductivity σ_{\min} , shall be:
1. $10^{-16} \Omega^{-1} \text{ m}^{-1}$ when mean daily temperatures are in excess of 25°C ,
 2. $2 \times 10^{-17} \Omega^{-1} \text{ m}^{-1}$ for other temperatures, or
 3. a value agreed with the customer.

NOTE 1 When determining the value agreed with the customer, it is important to take into account the degradation of the material.

- NOTE 2 Hence the threshold value of charging current is $2 \times 10^{10} \text{ A m}^{-1}$ based on the default values of E_{\max} and σ_{\min} ($1 \times 10^{-9} \text{ A m}^{-2}$ for materials in excess of 25° C).
- NOTE 3 The current density of $2 \times 10^{-10} \text{ A m}^{-2}$ above, is not exceeded for a radiation shielding thickness of 5,1 mm aluminium for all terrestrial orbits and 2,6 mm for GEO according to the FLUMIC version 2 flux model and DICTAT shielding calculations (see Annexes D.2.1, D.3.1 and E.3.3).
- NOTE 4 A conductivity value of $2 \times 10^{-17} \Omega^{-1} \text{ m}^{-1}$ lies below the normal range of bulk dielectric conductivity at room temperature. Although bulk conductivity can be even lower than this at lower temperatures, the addition of radiation-induced conductivity makes lower values unlikely.

ECSS-E-ST-20-06_0070172

- g. Detailed assessment of the surface voltages on internal surfaces need not be performed if the following has been established.

1. The thickness of the dielectric is less than 0,1 mm.
2. The product of charging current density and thickness is very low.

NOTE 1 To item 1: In this case meeting the electric field requirements also meets the internal surface voltage requirement.

NOTE 2 To item 2: For $V_{\max}=1 \text{ kV}$ and $\sigma_{\min}=2 \times 10^{-17} \Omega^{-1} \text{ m}^{-1}$, this product is $2 \times 10^{14} \text{ A m}$.

NOTE 3 To item 2: i.e. less than the product of V_{\max} and σ_{\min} (as described in 9.3f)

ECSS-E-ST-20-06_0070120

- h. For materials other than those covered by 9.3e and 9.3f, a validation process shall be carried out to establish that the maximum electric field and internal absolute surface voltage remain below E_{\max} (10^7 V/m) and V_{\max} respectively, when irradiated with the worst-case environment, in the orbit and position on the spacecraft and at the lowest temperature, in which it is intended to be used.

NOTE 1 This involves either

- experimental validation using a worst-case spectrum in a laboratory chamber, or
- computer simulation.

NOTE 2 For simple structures a 1-d analytical charge deposition and conductivity code such as given in annex D.2 can be suitable. This calculation uses information on the environment and the density of the shield and dielectric and its electrical properties. For complicated structures, 3-d Monte

Carlo simulations can be used to calculate current deposition. However, after this the field is calculated using the electrical properties of the structure.

ECSS-E-ST-20-06_0070121

- i. For systems sensitive to absolute levels of internal electric fields and comprising insulators or isolated conductors, an analysis of the susceptibility to internal charging shall be made.

NOTE For devices like triaxial accelerometers, this is most likely to be achieved using particle transport codes. For MEMS devices, where the trapping of charge in dielectric layers is not easily calculated, this is most likely to be achieved by laboratory simulation. In all cases, it cannot be done without identification of suitable environment models. This can include energetic proton and ion models where these are significant sources of deposited charge.

10

Tether requirements

10.1 Description

This clause refers to any thin conductive or non-conductive flexible cable, deployed from a spacecraft or used to join two parts of a spacecraft together.

Many of the characteristics of tether systems are related to the electrical interaction with the environment and fall within the scope of this standard. However, tethered missions are still experimental and very rare. Hence quantitative requirements are mission-specific. The requirements in this clause are not detailed or exhaustive but cover the common aspects that can be expected in such missions.

10.2 General

10.2.1 Hazards arising on tethered spacecraft due to voltages generated by conductive tethers

ECSS-E-ST-20-06_0070122

- a. The insulation shall be thick enough to withstand the maximum voltage on the cable.

ECSS-E-ST-20-06_0070123

- b. Differential charging between spacecraft surfaces and differential charging between spacecraft during rendez-vous shall be included in the risk assessment of electrostatic discharges.

NOTE Hazards arising on tethered spacecraft due to voltages generated by conductive tethers can include voltage across the tether insulation.

10.2.2 Current collection and resulting problems

ECSS-E-ST-20-06_0070124

- a. The current collecting area shall large enough to carry the current for the particular application.

ECSS-E-ST-20-06_0070125

- b. Sputtering and surface contamination which can occur if current is collected through ion impacts shall be within a level agreed with the customer.

10.2.3 Hazards arising from high currents flowing through the tether and spacecraft structures

ECSS-E-ST-20-06_0070126

- a. The effects of high currents flowing through the tether and spacecraft structures shall be within a level agreed with the customer.

NOTE 1 A solution is current limiting.

NOTE 2 Ohmic heating and extraneous magnetic fields are effects of current flow.

10.2.4 Continuity of insulation.

ECSS-E-ST-20-06_0070127

- a. The insulation shall remain free of holes and cracks during the lifetime of the material.

NOTE Even small holes in insulation can collect dangerous levels of current and can lead to currents flowing through undesired paths through the plasma or other parts of the spacecraft.

10.2.5 Hazards from undesired conductive paths

ECSS-E-ST-20-06_0070128

- a. The current shall not bypass the planned circuit due to conductive paths through the deployment mechanism.

NOTE This is particularly a problem if the tether insulation is compromised.

10.2.6 Hazards from electro-dynamic tether oscillations

ECSS-E-ST-20-06_0070129

- a. Hazards from oscillations associated with electrodynamic forces shall be analysed.

NOTE Hazards from electro-dynamic tether oscillations can increase strain on the tether. It is particularly a

problem if the tether is to be retrieved because the tether can jam the retrieval mechanism.

10.2.7 Other effects

ECSS-E-ST-20-06_0070130

- a. Mechanical hazards to the spacecraft and the debris hazards to other spacecraft associated with a tether that breaks due to electrical burn-out or other cause shall be analysed.

ECSS-E-ST-20-06_0070131

- b. Effects of electrostatic sticking from static electricity or environmentally induced charging shall be analysed.

NOTE Other requirements for the design of a tether system lie outside of the scope of this standard, e.g.

- mechanical strength,
- outgassing,
- meteoroid/debris impact,
- radiation degradation,
- atomic Oxygen,
- thermal expansion, and
- twisting stresses

10.3 Validation

ECSS-E-ST-20-06_0070132

- a. A calculation of the maximum expected voltage between the two ends of the tether shall be made.

NOTE 1 This maximum expected voltage depends on orbit altitude and inclination.

NOTE 2 Nominal voltages for a conductive tether system can be ascertained by simulation of orbital velocity with an appropriate magnetic field model. It is important to note, however, that in addition to this nominal voltage, significant voltages can be generated in the tether by dynamic changes in the Earth's magnetic field.

ECSS-E-ST-20-06_0070133

- b. A calculation of the current flowing through the tether shall be made.

NOTE Current collection depends on the area of the collector and the voltage. Unless the collector is a simple shape e.g. spherical, it is likely that

geometrical model of the current collection are used to calculate the total current collected. Generally, tethers are in low Earth orbit where space-charge limited current collection applies.

ECSS-E-ST-20-06_0070134

- c. Insulator continuity shall be verified by a cable spark test in which the cable is drawn through a high voltage electrode which brushes the outside of the cable to detect imperfections in the insulator.

ECSS-E-ST-20-06_0070135

- d. Circuit analysis shall be performed to verify that the current passing through the deployment mechanism is within the level agreed with the customer.

11

Electric propulsion requirements

11.1 Overview

11.1.1 Description

Electric propulsion (EP) thrusters range from low thrust attitude control thrusters, to moderate thrust engines for station keeping, to high thrust engines for orbit raising and interplanetary flight. All systems which emit charged particles to create thrust are covered by these requirements, including:

- field-emission electric propulsion (FEEP) thrusters;
- gridded ion engines (e.g. radio-frequency and Kaufmann);
- electrodynamic thrusters (e.g. Hall effect);
- magneto-plasma dynamic thrusters.

Neutralising electron or neutral plasma emitters form an integral component of many of these systems and are considered in the same design and testing process. In addition, neutralizers can be used to control spacecraft potentials arising from natural causes. Hence, these requirements cover neutralizers, including:

- plasma contactors;
- FEEP neutralizers;
- electron beam emitters;
- heated filament emitters.

For EP systems that emit uncharged particles, e.g. electro-thermal systems, most of the requirements of this document are not relevant. However, they do emit contaminants and neutral plasmas that can affect electrostatic interactions outside the spacecraft and so are covered by this standard in these respects.

11.1.2 Coverage of the requirements

ECSS-E-ST-35 and E-ST-35-01 cover all electric propulsion systems used on spacecraft including those discussed here. That standard gives top-level requirements including performance, interfaces, operation, quality and verification.

The requirements described in the present Standard cover:

- Design requirements arising from the interaction of the spacecraft with the plasma and electric and magnetic fields outside the spacecraft, including those generated by neutralizers, and presented in 11.2. These requirements are related both to the effect of the plasma environment on the operation of the EP system and the effect of the EP system on other spacecraft systems through its interaction with the environment.
- Validation requirements on ESD validation of electric propulsion systems, covered in 11.3. This addresses both the method of validation and specific aspects to be validated.
 - Validation is achieved mainly through ground testing and computer modelling. Both of these approaches have limitations, and it is important to give careful consideration to using complementary experimental and computer simulations to provide confidence in different aspects of a design.
For systems with flight heritage, in-flight performance monitoring can provide further validation.
 - Ground testing is covered in 11.3.1. The ground testing of EP systems involves vacuum chambers. To minimize wall effects on beam characteristics, chambers are large compared to the size of the thruster and the vacuum quality is continuously monitored. However, the accuracy of the measurements suffers from the physical limitations imposed by the chamber. For example, chambers usually have a higher background plasma density than the one found in orbit and usually do not show the full effect of beam space-charge, since the beam is neutralized by impact with the chamber wall or target. Similarly, there is usually increased sputtering in the chamber because of the higher plasma density.
 - Computer modelling is covered in 11.3.2. Computer modelling of the EP system and its spacecraft plasma interaction is the most complete way to get a deep insight into the behaviour of a thruster on a spacecraft. However, computer simulations generally involve simplifications and approximations which make simulations practical within limited resources.
 - In-flight monitoring is covered in 11.3.3.
 - Requirements on particular aspects of ESD validation are covered in 11.3.4 (spacecraft neutralization), and 11.3.5 (beam neutralization).

There are a number of other environmental interactions of EP systems that are addressed by designers that are not covered here, e.g.

- Neutralizers as sources of EMC interference. (ECSS-E-ST-20-07 applies).
- Ion thrusters and neutralizers and the emitted beams as sources of optical and UV light and thermal radiation.
- EP plasma beams interfering with reception and transmission of radio communications.

11.2 General

11.2.1 Spacecraft neutralization

ECSS-E-ST-20-06_0070136

- a. The neutralizer current capacity shall be greater than the maximum beam current plus the natural charging currents in a worst case charging environment.

NOTE 1 In general, charged particle currents from the environment are insufficient to neutralize the spacecraft and a neutralization system is provided with capacity to supply more current than the EP beam.

NOTE 2 See ECSS-E-ST-10-04 for worst case environments for different orbits.

NOTE 3 The objective of the requirement is to ensure that the beam current produced by the EP system is completely neutralized. Failure to ensure neutralization can lead to high absolute and differential spacecraft potentials, causing interference with other systems and possible spacecraft damage, severe loss of EP efficiency and contamination and erosion of spacecraft surfaces.

ECSS-E-ST-20-06_0070137

- b. If neutral plasma thrusters have an integral cathode (effectively an integral neutralizer) which neutralizes the beam and is used as part of the ionization process, the neutralizer requirements in 11.2.1a shall be applied to these cathodes.

NOTE Hall effect thrusters are neutral plasma thrusters.

ECSS-E-ST-20-06_0070138

- c. Thrusters shall not be operated on-board spacecraft without their associated neutralizers.

ECSS-E-ST-20-06_0070139

- d. There shall be a ground path linking the neutralizer and the ion beam emitter so that there is a complete circuit including the flow of neutralizer electrons and thruster ions in space.

NOTE Unless there is a direct ground path linking the thruster and the neutralizer directly, so that the neutralization current does not pass through other on-board systems, there can be EMC issues.

ECSS-E-ST-20-06_0070173

- e. If in low thrust systems e.g. FEEPs, in LEO, if it is demonstrated by an analysis which includes the worst case natural currents, that neutralization can be achieved through natural ionospheric currents, a neutralizer may then be omitted.

NOTE This case is expected to be highly unusual.

ECSS-E-ST-20-06_0070141

- f. Except in the case specified in 11.2.1g, those neutralizers on spacecraft without active EP thrusters whose role is to control natural charging levels, shall be attached directly to spacecraft ground.

ECSS-E-ST-20-06_0070142

- g. If the spacecraft is intended to be held at a bias voltage, the neutralizer shall be attached to ground via a power source [or resistance network](#).

ECSS-E-ST-20-06_0070143

- h. The current capacity of the neutralizers whose role is to control natural charging levels shall be higher than the largest natural charging current.

ECSS-E-ST-20-06_0070144

- i. Neutralizers emitting particles of one polarity shall have active current control and measurement of spacecraft potential.

NOTE Measurements can also be useful for diagnosis of thruster operation.

ECSS-E-ST-20-06_0070174

- j. Except in the case specified in 11.2.1k, neutralizers that emit charged particles of one polarity should not be used.

NOTE 1 An example is electron guns.

NOTE 2 The reason is that they can increase differential charging levels and can be rendered ineffective by potential barriers.

NOTE 3 These emitters use active control of the emitter current in the light of real-time potential measurements to maintain a fixed potential.

ECSS-E-ST-20-06_0070175

- k. Provision 11.2.1j need not be satisfied in the following cases:
1. If it can be shown that differential surface charging remains below 100 V.
 2. If scientific measurements can be contaminated in the environment induced by other types of neutralizers.

NOTE 1 To item 1: An example is when the surface is completely conductive or when the ambient plasma is very cold.

NOTE 2 To item 2: Examples are ambient plasma measurements.

11.2.2 Beam neutralization

ECSS-E-ST-20-06_0070147

- a. Beam neutralization shall be achieved by design.

NOTE The level of space-charge potential in the beam and the volume of space it occupies depends on the efficiency with which neutralizer electrons penetrate and neutralize the beam itself. Failure to neutralize the beam close to the spacecraft can result in increased contamination from charge exchange ions produced in the beam and increased beam divergence leading to some loss of thrust.

ECSS-E-ST-20-06_0070148

- b. The efficiency of the neutralization shall be assessed through plasma simulation or testing.

ECSS-E-ST-20-06_0070149

- c. The electrostatic perturbation resulting from the assessment specified in 11.2.2b shall be within a level agreed with the customer.

11.2.3 Contamination

ECSS-E-ST-20-06_0070150

- a. Contamination due to neutral and charged particles shall be below a level defined by the customer.

NOTE Acceptable levels of contamination vary and are established on a case by case basis. Optical surfaces and thermal control surfaces can have lower acceptable levels than other surfaces.

ECSS-E-ST-20-06_0070151

- b. The level of contamination due to the contaminants shall be assessed through simulation or testing.

NOTE 1 A fraction of the neutral atoms that exit EP systems return to the spacecraft after ionization. These atoms include propellant and material eroded from the thruster itself (e.g. atoms from electrostatic grids).

NOTE 2 Propellant for thrusters and neutralizers and the materials used to construct the thrusters are selected with their effects as contaminants in mind. The use of noble gasses as propellant and neutralizer medium is a typical practice partly for this reason. An issue to be considered is the type of atoms emitted from the EP system and their spatial distribution.

11.2.4 Sputtering

ECSS-E-ST-20-06_0070152

- a. Sputtering by impact of charge exchange ions on surfaces shall be verified to be below a level agreed by the customer.

11.2.5 Neutral gas effects

ECSS-E-ST-20-06_0070153

- a. It shall be verified that the level of plasma density is not high enough to produce discharges through the gas.

NOTE EP systems can emit substantial quantities of neutral gas. Examples are gas emitted by electrothermal thrusters and gas emitted by gridded ion engines and electrodynamic thrusters at start-up before the internal discharges are initiated. These neutral gas emissions, after photo-ionization, can dramatically increase the plasma density around the spacecraft. This can result in the triggering of discharges on charged surfaces or between surfaces actively kept at different potentials.

11.3 Validation

11.3.1 Ground testing

ECSS-E-ST-20-06_0070154

- a. If ground testing is used for ESD validation of electrical propulsion systems, the effects of vacuum chamber limitations used in the test shall be established through modelling.

NOTE 1 For example, by computer simulation.

NOTE 2 Detailed requirements for ground testing, e.g. size of chamber, and accuracy of diagnostics depend on the thrusters under test. Thrust range, plasma

density and ion energy varies strongly from one thruster to another.

11.3.2 Computer modelling characteristics

ECSS-E-ST-20-06_0070155

- a. Computer models shall include the geometry of the spacecraft and its operative environment including thruster, power supply, grounding scheme and surfaces surrounding the thrusters and its plume.

ECSS-E-ST-20-06_0070156

- b. Modelling of the thruster plume shall include a description of the plasma velocity distribution, the electric fields around the spacecraft and the boundary conditions on the spacecraft surface.

ECSS-E-ST-20-06_0070157

- c. Computer models shall be validated with data coming from ground tests or with flight tests.

11.3.3 In-flight monitoring

ECSS-E-ST-20-06_0070176

- a. The spacecraft potential and the plasma environment in any mission using electric propulsion should be monitored.

NOTE Measurement of performance of EP systems is an important means of giving confidence in a design and in ground testing and computer simulations. The reason for the requirement is because the full range of plasma interaction processes in space cannot be simulated in a vacuum chamber or by computer code.

11.3.4 Sputtering

ECSS-E-ST-20-06_0070159

- a. Except as specified in 11.3.4b, computer simulation shall be used to analyse ion trajectories and determine their sputter effects during normal operation.

ECSS-E-ST-20-06_0070177

- b. Transient trajectories during switch-on or switch-off may be excluded from the analysis specified in 11.3.4a

11.3.5 Neutral gas effects

ECSS-E-ST-20-06_0070161

- a. An assessment shall be made of the plasma density around the spacecraft arising from neutral gas emissions from the EP system.

NOTE It is unlikely that the level of plasma density around a spacecraft due to neutral gas emission from EP systems can be adequately assessed using a laboratory simulation. In-flight observation, using as an example Langmuir probes, can be used for the assessment, otherwise, calculation or computer simulation is used. This analysis is expected to take into consideration the flow rate of the gas, its temperature and its rate of ionization.

ECSS-E-ST-20-06_0070178

- b. <<deleted>>

Annex A

Annex A (normative)

Electrical hazard mitigation plan - DRD

A.1 DRD identification

A.1.1 Requirement identification and source document

This DRD is called from ECSS-E-ST-20-06, requirement 5a.

A.1.2 Purpose and objective

Hazards in this context are all electrical effects that are unwanted because they significantly reduce capability or redundancy. The objective of the plan is to ensure that the risk of hazards is adequately analysed and that adequate counter-measures are taken where necessary.

A.2 Expected response

A.2.1 Scope and content

ECSS-E-ST-20-06_0070163

- a. The electrical hazard mitigation plan shall include the following elements:
 1. Assessment of the environmental characteristics of the mission, including:
 - (a) consideration of the spacecraft orbit, and
 - (b) whether this is LEO, MEO, GEO or extra-magnetospheric.
 2. Assessment of the electrical characteristics of the spacecraft, including:
 - (a) consideration of whether electric propulsion is used,
 - (b) whether the mission includes scientific field or plasma measurement instruments, and
 - (c) whether there are high voltage systems or systems with particular vulnerability.
 3. Specification of relevant design requirements.
 4. Analysis, simulation or testing of exceptions.

5. Testing of design implementation.

NOTE 1 To item 1: ECSS-E-ST-10-04 gives nominal and worst-case environment for various mission types.

NOTE 2 To item 3: For tailoring guidelines on this, refer to Annex B.

NOTE 3 To item 4: This requirement is to ensure an individual assessment of the components that falls outside the requirements of this Standard.

A.2.2 Special remarks

None.

Annex B (informative)

Tailoring guidelines

B.1 Overview

In the following text, the orbital regimes are defined as follows for near circular orbits:

LEO – altitude below 1500 km;

MEO – altitude from 8000 km to 25000 km;

GEO – altitude from 25000 km to 60000 km (usually 36000 km).

In practice, there are very few spacecraft between LEO and MEO because of the severity of the proton belts. In the GEO regime, the majority of operational spacecraft are in the 36000 km, zero degrees inclination geostationary orbit. The GEO type of environment can be encountered however from about 25000 km to about 60000 km. Highly eccentric orbit (HEO) spacecraft including those in geostationary transfer orbit (GTO) are considered to have both LEO and MEO/GEO requirements. Spacecraft on high inclination orbit with altitude below 8000 km altitude going through the auroral oval are subject to MEO/GEO requirements in addition to the possible LEO requirements. Beyond altitudes where the GEO environment is encountered, there are various regions with different plasma regimes less severe than the GEO environment regarding charging effects.

B.2 LEO

B.2.1 General

LEO orbits extend up to 1500 km and can have any orbital inclination. Requirements associated with the following are intended to be adopted by all LEO spacecraft with exposed high voltage systems, e.g. high voltage solar arrays:

- High voltage interactions (clause 8).
- Solar array ESD effects on the array itself (clause 7).

In LEO orbits, unless the spacecraft has electric field sensitive instruments, requirements need not be considered specifically directed at internal parts and materials (clause 6).

B.2.2 LEO orbits with high inclination

LEO orbits with inclination of 55 degrees and above can frequently intercept auroral arcs. Here, the spacecraft experiences a higher energy electron environment similar to that of geostationary orbit. Requirements concerned with the following are intended to be adopted by spacecraft in these high-inclination orbits:

- Surface charging (clause 6). However, an electrostatic discharge does not occur unless the charging process is sufficiently rapid to reach dangerous potential values within the time taken to cross the oval (about 90 s). Hence the requirements can be relaxed, in order to retain dielectrics and floating metallic parts, with capacitance above 50 pF per cm² of area, exposed to the environment since they do not charge up dangerously in the time available, even if unfavourable in terms of secondary yield, conductivity etc. As a result of this relaxation, large areas of ungrounded MLI can be used if assessed to have high capacitance.

NOTE The capacitance is that of the whole structure, not that of a single layer i.e. for MLI with N layers, the total capacitance is the result of the combination in series of N capacitors.

$$\frac{1}{C} = \frac{1}{C_1} + \frac{1}{C_2} + \dots + \frac{1}{C_N}$$

Analysis or simulation take into account the neutralising current from LEO ambient plasma. However, surfaces in a wake do not see this current and the analysis resembles that for GEO.

- Solar array ESD effects on the array itself (clause 7).
- High voltage interactions (clause 8).

B.3 MEO and GEO orbits

The requirements concerned with the following are intended to be adopted by spacecraft in MEO and GEO orbits:

- Surface charging (clauses 6 and 7).
- Solar array ESD effects on the array itself (clause 7).
- Internal parts and materials (clause 9).

Specific requirements need not be applied for high voltage interactions (see clause 8).

B.4 Spacecraft with onboard plasma detectors

Scientific satellites have more stringent requirements for electrical neutrality, where they are concerned with monitoring the ambient plasma environment. Parameters that can be relevant include:

- electric field;

- plasma density, temperature, spectrum and velocity;
- charging state of target materials.

The additional requirements for satellites with electric field sensitive measurements (clause 6.7) are intended to be adopted by scientific satellites.

B.5 Tethered spacecraft

Requirements for tethered systems (clause 10) are intended to be adopted by spacecraft carrying tethers of greater length than 1 km. For scientific missions, shorter tethers can make these requirements applicable, depending on the whether a minimum spacecraft voltage is specified. Long wire antennas for electric field measurements about a spinning spacecraft do not represent a problem because:

- they are comparatively short (generally less than 100 m);
- they are deployed symmetrically about the spacecraft so result in little net charging;
- the spacecraft spin inhibits electrically induced oscillations in the wire.

B.6 Active spacecraft

Active spacecraft emit plasma, neutral gas or charged particles. Requirements concerning electric propulsion systems (clause 11) are intended to be adopted by such satellites.

B.7 Solar Wind

For satellites in the solar wind high level charging does not occur because the bulk electron temperature is less than a few electron volts. However, plasma measurement instruments [sometimes need](#) control of spacecraft potential and fields.

B.8 Other planetary magnetospheres

Spacecraft orbiting planets other than the Earth are not specifically covered by the requirements detailed in this document. However they have similar electric requirements depending on the characteristics of the planetary environments. Jupiter and Saturn, in particular, have extensive magnetosphere which produce electrostatic hazards similar to those seen around the Earth.

Annex C (informative)

Physical background to the requirements

C.1 Introduction

Assessment or mitigation of the spacecraft plasma interactions are based on a quantitative description of the phenomena. The key parameters for such a quantitative description are provided in this Clause.

C.2 Definition of symbols

In equations used in this clause, the following definitions of common symbols can be assumed, if not stated in the text:

B – magnetic field in Tesla

$\epsilon, \epsilon_0, \epsilon_r$ - dielectric constant, dielectric constant in vacuum, relative dielectric constant

f – distribution function in $\text{m}^{-6} \text{s}^{-3}$

I – current in Amperes (A)

j – current density in A/m^2

k – Boltzmann constant, i.e. $1.38 \times 10^{-23} \text{JK}^{-1}$

m, M – mass in kg

n – density in m^{-3}

q, e – charge, electron charge in Coulombs

T – Temperature in Kelvin (K)

t – time in seconds

V – potential in volts (V)

v – velocity in ms^{-1}

C.3 Electrostatic sheaths

C.3.1 Introduction

An object in space has an induced charge on its surface. Due to the nature of the space plasma and the surface charges on the object a sheath develops around it,

e.g. around a spacecraft. The electrostatic sheath is a layer of net space charge that screens the distant plasma from the surface charges.

The sheath confines all of the significant electric fields, therefore its geometry relative to the spacecraft dimensions is of great importance for estimating the interaction between the spacecraft and the surrounding plasma including the collection and emission of particles. Conversely, ambient charged particle fluxes (ions and electrons), photoelectrons, backscattered and secondary electrons from the surfaces as well as actively emitted particles from, e.g. thrusters are taken into account together with spacecraft geometry and velocity, and any external magnetic fields when determining the properties of the sheath.

C.3.2 The electrostatic potential

In quasistatic conditions the ion and electron densities n_i and n_e , and the electrostatic potential V satisfy Poisson's equation,

$$\Delta V = -\frac{e}{\varepsilon_0}(n_i - n_e)$$

where ε_0 the dielectric constant in vacuum. and e the electron charge.

In vacuum the electrostatic potential, V , from an isolated punctual charge, q , is given by

$$V = \frac{q}{4\pi\varepsilon_0 r}$$

where r is the distance from the charge. It is seen that the potential falls as $1/r$ in this case.

C.3.3 The Debye length

It can be shown that the potential, V , around an infinitesimal perturbation of charge q at a distance r is given by

$$V = \frac{q}{4\pi\varepsilon_0 r} e^{-\frac{r}{\lambda_d}}$$

with

$$\lambda_d = \left(\frac{\varepsilon_0 kT}{ne^2} \right)^{\frac{1}{2}}$$

where:

- k is Boltzmann's constant,
- T the electron temperature,
- n the plasma density, and
- e the electron charge.

λ_d is called the Debye length. It is a characteristic length scale of the shielding of the electric field by the plasma around a small perturbation. In a non-

perturbed plasma the space charge vanishes over volumes greater than the Debye length. Around a large electric perturbation the electric field is shielded as well but over a length scale which can be several order of magnitude greater than λ_d . The region around such a perturbation where the plasma is not neutral is called the sheath.

Normal range of values of the Debye length in a various plasma region are given in Table C-1.

Table C-1: Parameters in different regions in space

Plasma region	Density (m^{-3})	Temperature (eV)	Debye length (m)
Interstellar	10^6	10^{-1}	1
Solar corona	10^{13}	1 - 10^2	$10^{-2} - 10^{-3}$
Solar wind	$10^3 - 10^9$	1 - 10^2	1 - 10^2
Magnetosphere	$10^6 - 10^{10}$	10 - 10^3	1 - 10^2
Ionosphere	$10^8 - 10^{12}$	10^{-1}	$10^{-1} - 10^{-3}$

Note that the energy unit of the electron volt (eV) is widely used to express the temperature (kT) of a space plasma (hence 1 eV = 11605 K). Note also that photoelectrons or secondary particles from the spacecraft can change the properties of the plasma near the spacecraft. The plasma in these regions is dynamic and values outside of those given in Table C-1 can occur.

C.3.4 Presheath

The presheath is a quasi-neutral region that matches the sheath to the undisturbed plasma (see Figure C-1).

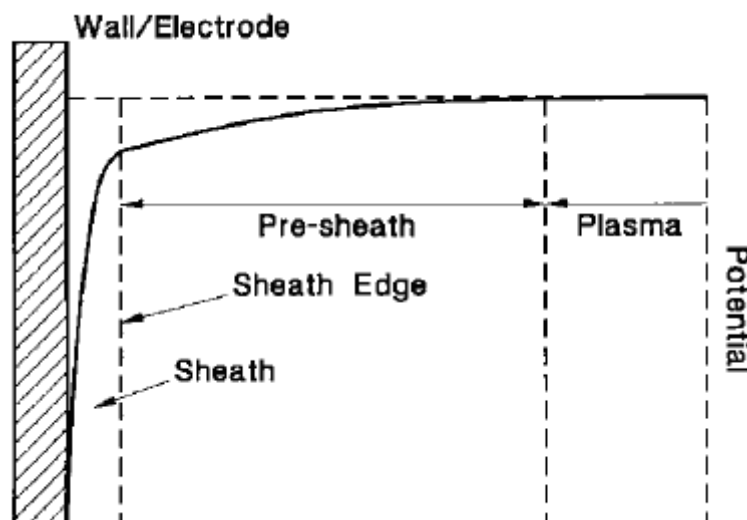

Figure C-1: Schematic diagram of potential variation through sheath and pre-sheath.

C.3.5 Models of current through the sheath

In a non perturbed plasma the plasma current impacting an infinitesimal surface A is related to the distribution functions of each species i , $f_i(v)$, by

$$I = A \sum_i q_i \int w_{\perp} f_i(v) dv$$

where v_{\perp} is the velocity perpendicular to the surface A and q is charge.

For a Maxwellian Distribution

$$f(w) = 4\pi n \left(\frac{m}{2\pi kT} \right)^{3/2} v^2 \exp\left(\frac{-mv^2}{2kT} \right)$$

where

- n is density,
- k is the Boltzmann's constant, and
- T is the temperature,

The current density related to each species can be expressed as:

$$I_i = A q_i n_i \left(\frac{kT_i}{2\pi m_i} \right)^{1/2}$$

When the temperature of the various species are close to each other the sum of the terms I_i is negative because the mass of the electron is much less than the one of the ions.

As shown in the clauses C.3.2 to C.3.4, the plasma around an object is, in general, perturbed and the amount of current that flows to the object is intricately related to the sheath structure. The sheath structure is determined in general numerical iterative algorithm to find a self-consistent solution of the Poisson and Vlasov system of equations. There are however limiting cases for which the current through the sheath can be easily calculated. Two of these limiting cases are described in C.3.6 and C.3.7.

It can also be noted for repelled Maxwellian species and when the geometry of the surface is symmetric enough the current collected is simply given by:

$$I = A q n \left(\frac{kT}{2\pi m} \right)^{1/2} \exp\left(\frac{qV}{kT} \right)$$

where V is the repelling voltage.

C.3.6 Thin sheath – space-charge-limited model

If the sheath thickness is much less than the curvature radius of the spacecraft surface the sheath can be locally assumed to be planar and a space-charge-limited current assumption can be made. This model has also been called the Child-Langmuir (space-charge-limited) diode model.

The current in a planar thin sheath model can be estimated from:

$$I = \frac{4}{9} \left(\frac{2e}{M} \right)^{1/2} \frac{\epsilon_0 |V|^{3/2}}{d^2}$$

and an expression for the sheath thickness, d , can be written

$$d = \frac{2}{3} \left(\frac{\sqrt{2}}{K^*} \right)^{1/2} \lambda_D \left(\frac{|qV|}{kT} \right)^{3/4}$$

if the current density is defined by

$$j = j_0 = K^* q n_0 \sqrt{\frac{kT}{m}}$$

K^* is 1 for a monoenergetic beam.

Langmuir and Blodgett also developed a space-charge-limited theory for radial electron flow from spherical diodes in 1924 [1].

C.3.7 Thick sheath – orbit motion limited (OML) model

If the sheath thickness is much greater than the central spacecraft dimension, the ability of particle to reach the surface is more limited by particle orbit considerations than by the size of the sheath.

If the spacecraft can be considered as a sphere of radius R , it can be shown that for an attracted particle with mass m , speed, v_0 and charge q , to reach the spacecraft, a condition is that its impact parameter R_i is below a critical value as follows:

$$R_i^2 = R^2 \left(1 - \frac{2qV}{mv_0^2} \right)$$

The total current of this attracted species striking the satellite surface for a monoenergetic beam can be written as:

$$I = 4\pi R^2 q n v_0 \left(1 - \frac{2qV}{mv_0^2} \right)$$

If the attracted species have a Maxwellian distribution their current on the spacecraft is

$$I = 4\pi R^2 q n \left(\frac{kT}{2m} \right)^{1/2} \left(1 - \frac{qV}{kT} \right)$$

By comparing the ratio

$$\xi = \frac{R \left(1 - \frac{qV}{kT} \right)^{1/2}}{d}$$

with respect to unity, it can be estimated, in principle, whether the orbit motion limiting theory ($\xi \ll 1$) or the sheath limiting theory ($\xi \gg 1$) applies. When this ratio is around 1, none of these theories is a priori suitable and more complex models (cf below) are used. In practice it seems that the applicability of the OML approximation is much wider than $\xi \gg 1$.

C.3.8 General case

The formulas given in C.3.7 do not apply when outside the limiting regime or when particles are emitted from the surface or when the spherical symmetry condition is not fulfilled. The problem can be resolved by solving the complete Vlasov-Poisson system of equations

$$\begin{cases} \frac{\partial f}{\partial t} + \vec{v} \cdot \nabla f + \frac{\vec{F}}{m} \cdot \frac{\partial f}{\partial \vec{v}} = 0 \\ \Delta V = -\frac{e}{\epsilon_0} (n_i - n_e) \end{cases}$$

where F stands for the force applied on the species described by the distribution function.

In case of spherical symmetry the Turning Point formulation method can be used to solve this system (see e.g. [1]). In the more general case, current can be computed via Particle-in-Cell simulations codes. Example of two of them are PicUp3D and SPIS (see [3]).

C.3.9 Magnetic field modification of charging currents

Charged particles gyrate around magnetic field lines under the $v \times B$ effect. Where fields are intense and electron energies are small (e.g. ambient electrons in LEO and secondary and photo-electrons generally), gyro-radii can be small. This modifies the charging currents, e.g. by restricting photo-emission.

C.4 Current collection and grounding to the plasma

For high potential surfaces such as solar array interconnects, the presence of dense plasma allows current to flow through the plasma, by collection of electrons and ions to positive and negative surfaces respectively.

This effect is particularly significant for LEO orbits where the plasma is dense and spacecraft surface potentials, e.g. on solar arrays, can be very high compared to the plasma temperature. The size of the current depends principally on the size of the sheath, which can be significantly larger than the surface itself. For example, the sheaths produced by positively charged solar array interconnects can merge (the snap-over effect) so that the effective collecting area is the whole array surface. Conversely, the presence of nearby strongly negatively charged areas can create a potential barrier preventing current collection to a small positive surface.

The higher mobility of electrons compared to ions means that current collection is far more efficient to positive surfaces and leads to these surfaces being driven towards plasma ground. This means that the way in which a solar array is connected to the spacecraft ground can affect the equilibrium potential of the whole spacecraft i.e.

- Negative end of the solar array connected to spacecraft ground – a small portion of the solar array remains slightly positive with respect to the

plasma. The spacecraft ground floats negative with respect to the plasma at a substantial fraction of the array potential.

- Positive end of the solar array connected to spacecraft ground – the spacecraft ground remains very close to plasma potential. The solar array is negative.

The current that is effectively passing through the plasma from end of the solar array acts to the other acts as a drain on the power produced by the array. Usually this is a very low percentage of the total power but the percentage rises with solar array voltage for the same effective surface area.

In a similar way, to solar arrays, current collection occurs at both ends of a conducting space tether. In this case current collection is needed as it controls the effectiveness of a tether on tethered spacecraft. Whether a tether is being used to generate power or is being used as a motor by passing a current along it, effective collection of current from the plasma is required at both ends. For the positive end, passive electron collection is usually sufficient but for the negative end, an electron gun is often used.

3-D spacecraft-plasma interaction modelling codes such as SPIS (see D.1.1.4) can be used to analyse current collection effects.

C.5 External surface charging

C.5.1 Definition

In the context of this document, surface charging refers to the build-up of electric charge on spacecraft surfaces (see [4], [5] and [6]).

C.5.2 Processes

Charges can appear on spacecraft surfaces via various processes including: conduction, irradiation, ionization and polarization. Even ambient charged particles with very low energy can a priori deposit charge on material surfaces. Therefore, surface charging usually involves the ambient space plasma which has typical ion and electron temperature ranging from 0,1 eV (in the ionosphere) to several keV in the aurora or the plasma sheet (see ECSS-E-ST-10-04).

The charge deposition rate on the surface due to the low energy ambient charged particles has been explained in the clause C.3.

Ionization is due to the higher energy part of the space radiation spectrum (UV, soft X-ray and charged particles with energy of the order of 100 eV or above).

Charging levels have been observed in a range between tens of volts positive to tens of kilovolts negative.

C.5.3 Effects

The surface charge deposition process can directly affect the operation of space systems via the related electric current flowing in the structure. Another effect is to generate an electric field in the vicinity of the spacecraft which can further lead to a series of disturbances:

- acceleration of particles toward surfaces (contamination, erosion);
- artefacts on particle and field sensors;
- acceleration of particles emitted by active devices;
- material breakdown and related powerful electrostatic discharge;

C.5.4 Surface emission processes

C.5.4.1. General

Impacting particles or photons with energy of the order of 10 eV or above can induce a significant amount of electron emission.

C.5.4.2. Photo-electron emission

For average effects involving the bulk of the distribution function of photo-electron speed, the distribution can be represented by a Maxwellian of equivalent temperature T_{ph} . [8]. The current leaving the surface A of a spacecraft perpendicular to the sun direction is given by

- for $V \leq 0$: $I_{ph} = Aj_{ph}$
- for $V > 0$:
 - for a planar source, $I_{ph} = Aj_{ph} \exp\left(-\frac{qV}{kT_{ph}}\right)$
 - for a point source, $I_{ph} = Aj_{ph} \left(1 - \frac{qV}{kT_{ph}}\right) \exp\left(-\frac{qV}{kT_{ph}}\right)$

where j_{ph} is the photo-electron density current at saturation.

The source can be considered as planar if the sheath thickness is much less than the curvature radius of the surface and as punctual if the sheath thickness is much larger than the curvature radius of the surface. The saturation photo-electron current, J_{ph} , depends on the material.

In some cases a better approximation is obtained by using a more sophisticated description of the photo-electrons, as for example a bi-Maxwellian distribution [9].

C.5.4.3. Secondary-electron emission

Secondary electrons are also emitted as a result of primary electron and ion radiation in the energy range 10 eV to a few 10s of keV. For spacecraft charging computations it is common practice to use the approach of Katz et al. 1977 (see [6]) to calculate secondary yield.

Secondary emission plays a crucial role in determining whether hazardous levels of charging arise. An example of the dependence of secondary yield on incident particle energy is given in Figure C-1. At high energy where yield is below 1, an incident electron causes charging to build up. At lower energies where the secondary yield is greater than 1, the incident electron actually reduces charging. Hence the charging produced depends on the ratio of electrons above and below the point where the yield equals 1. This point is typically in the range of a few keV for most dielectrics.

Calculated secondary electron yield for Kapton

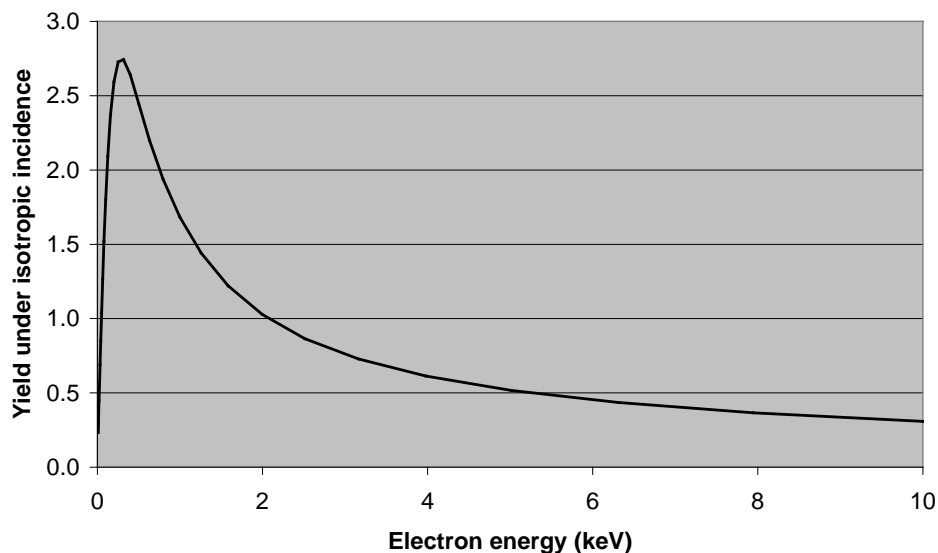

NOTE: Curve calculated according to the formula of Katz et al. 1977 [6]

Figure C-2: Example secondary yield curve

C.5.4.4. Other surface emission processes

It is important to note that there are other processes that can increase the number of charged particles leaving surfaces, including, charge exchange, backscattering and sputtering and this can significantly affect surface potential levels. All these surface processes can vary strongly from one material to another.

C.5.5 Floating potential

Accumulation of charge on spacecraft surfaces leads to changes in their potentials. In most cases these potential changes tend to reduce the flow of attracted charged particles and increase the flow of repelled charged particles. Ultimately, an equilibrium can be reached corresponding to a net current to the

system equal to zero. Such an equilibrium potential in a plasma is called the floating potential.

When the dominant charging process is collection of ambient ions and electrons the floating potential is negative. This is because even when ions have a similar temperature to the electrons, the electrons are faster and impact uncharged spacecraft surfaces in higher numbers than the ions. In general, the floating potential of conductive structures is negative in the high density ionosphere and in eclipse with value in volts of the order of magnitude of the electron temperature in eV. This can mean charging levels of over 10kV in the outer magnetosphere.

It is the balance of all currents to the surface that determines the surface charging level. Usually this concerns the negative current from the impact of primary electrons and the positive currents from ion impact, secondary electron emission and photoemission. Conductive currents also occur and can be positive or negative.

Because secondary electron emission and photo-emission currents are the major currents that mitigate against strong negative charging, the secondary and photo-electron yield characteristics of surface materials are crucial in determining whether a surface is able to charge to hazardous levels. Selecting coatings, such as indium-tin-oxide, where the yield curve crosses unity at a high energy is a means of reducing the likelihood of hazardous charging. Floating spacecraft surfaces exposed to sunlight are often positively charged. When photo-emission is the dominant charging process, the floating potential can vary from the order of one volt positive in the topside ionosphere and the plasmasphere to several tens of volts positive in the depleted regions of the magnetosphere.

All the surface processes can strongly vary from one material to another which can explain difference of potential values achieved by different materials in similar environments.

Hazardous charging occurs when differential potentials greater than around 100 V occur. Such levels can exceeded commonly in the high-altitude plasma-sheet region of the magnetosphere and during low-altitude crossings of auroral arcs. Charging in the magnetospheres of other planetary magnetospheres, such as Jupiter and Saturn, can also reach hazardous levels.

C.5.6 Conductivity and resistivity

Charges can move from or to surfaces via conduction processes in the bulk of the material or on the surface. The surface and bulk conductivity can vary considerably from one material to another. The use of low conductivity material (e.g. Teflon) can favour the occurrence of differential charging especially between sunlit and non-sunlit surfaces. The resistivity is by definition the inverse of the conductivity.

A floating metallic part of area A exposed to space connected to the spacecraft ground through a resistance R can have a potential with respect to the ground equal to

$$V = JAR$$

where J is the current density through A .

An upper bound of the current density J can be set at 10 nA cm⁻² for current collection from the natural environment. Requirements on the maximum value of the potential sets requirements on AR .

For partially conductive materials of resistivity r , thickness t and surface A , laid on top of a more conductive material the resistance to the ground is

$$R \equiv \frac{rt}{A}$$

and the potential difference between the ground and the structure can be written

$$V = Jrt$$

Therefore requirements on the maximum potential on the dielectric set a requirement on rt .

For a partially conductive patch materials of thickness w , laid on top of a less conductive material e.g. an insulator, and grounded at the edges the conduction can occur through its whole thickness. The corresponding resistance is

$$R \equiv \frac{rd}{tw}$$

where

- d is the distance to the nearest ground, and
- w is the width perpendicular to the direction of the nearest ground.

The potential difference can then be assumed to be

$$V = \frac{rd^2}{t} J$$

Therefore requirements on the maximum potential over the dielectric set a requirement on rd^2/t .

Conduction can takes place at the surface within a thin layer of usually unknown thickness δ . The resistance of a rectangular patch grounded at 2 opposite edge separated by length d and with a perpendicular dimension w is then:

$$R = \frac{rd}{w\delta} \equiv R_s \frac{d}{w}$$

where R_s is so-called the surface resistance and is expressed in Ohm per square.

Therefore requirements on the maximum potential over the dielectric surface set a requirement on R_s .

It is important to note that the conductivity varies with the dose due to radiation, the temperature and the charging level (cf section on deep-dielectric charging). The surface conductivity also varies with the amount of contamination.

C.5.7 Time scales

A spacecraft structure has a capacitance of the order of the capacitance of a sphere of equivalent radius R , i.e.

$$C = 4\pi\epsilon_0 R$$

The characteristic charging time is

$$\tau = \frac{CV}{4\pi R^2 J} = \frac{\epsilon_0 V}{RJ}$$

It is of the order of 10^{-3} seconds for kV charging for $J=1$ nA cm⁻².

The capacitance of a dielectric patch with area A and thickness t is given by

$$C_t = \epsilon_0 \epsilon_r A/t$$

The time constant for differential charging is therefore:

$$\tau_d = \frac{C_t V}{AJ} = \frac{\epsilon_0 \epsilon_r V}{tJ}$$

It is of the order of 1 second for kV differential charging of a patch of thickness 1 mm under a current density of $J=1$ nA cm⁻².

High level charging environment typically lasts of the order of 1 hour at GEO and of the order of 1 minute at PEO.

C.6 Spacecraft motion effects

C.6.1 Wakes

C.6.1.1. Introduction

The interaction between a moving object and a stationary plasma leads to a disturbance in the local plasma, resulting in rarefaction on the downstream or wake side and, in the case where plasma is back-scattered, plasma compression on the upstream or ram side. These changes have consequences on the currents to surfaces and thus on the charging characteristics of the spacecraft. On the ram side, ion collection is enhanced and at the limit the ion current is approximately the ion density swept up by the spacecraft motion.

Figure C-3 (see [10]) shows that wakes have a complicated structure with ion streams that converge to form an axial peak, cross over and diverge in the far wake.

In the wake immediately adjacent to the spacecraft, ions are excluded because they have insufficient thermal velocity to enter this region from the downstream side. Usually, electrons have sufficient thermal velocity but because of the space charge that is created when they enter the wake without the ions, they too are largely excluded. As a result a region of less and higher space charge appears in the wake. The extent of the void region depends on the speed of the spacecraft relative to the speed at which the plasma can respond to fill it. Because the plasma acts collectively, it responds as fast as the ion acoustic velocity (v_s).

$$v_s = \left(\frac{kT_e + \gamma_i kT_i}{M_i} \right)^{1/2}$$

where:

- v_s is acoustic velocity in m s^{-1} ,
- k is the Boltzmann constant,
- T_e and T_i are electron and ion temperatures respectively in K,
- M_i is ion mass in kg, and
- γ_i is a constant, usually 3 for the case of plane waves.

In laboratory plasmas, the ion temperature is often negligible compared to that of the electrons and it is not uncommon to see the acoustic velocity written as:

$$v_s = \left(\frac{kT_e}{M_i} \right)^{1/2} \quad (T_i=0)$$

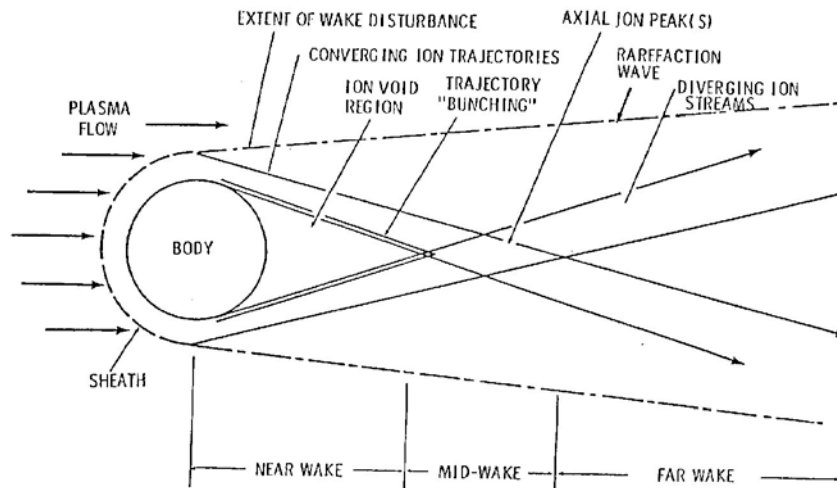

Figure C-3: Schematic diagram of wake structure around an object at relative motion with respect to a plasma

The Mach number (M) is the ratio of the spacecraft velocity (v_u) to the acoustic velocity

$$M = v_u / v_s$$

The rarefaction wave at the edge of the wake region has a characteristic angle to the velocity vector, the Mach angle (θ_M).

$$\theta_M = \sin^{-1}(1/M)$$

Where the object is uncharged, ion trajectories fill the wake void at the same angle. The length of the void is then given by the Mach angle and the width of the object (see Figure C-4).

An object in the wake, charged to a high negative potential, can cause the trajectories to converge at a higher angle and so the void can be shorter.

The wake void region is larger for large spacecraft and those with high Mach numbers. From Table C-2, it can be seen that wakes are most important at low altitudes.

The regime for which the spacecraft speed is higher than the ionic thermal speed but lower than the electron thermal speed is called meso-sonic. This is always the case on low altitude spacecraft.

Assuming a neutral wake with a Boltzmann electron distribution, Cooke 1996 [14] has shown that the potential in the wake V as a function of the radius r of the body in the limit of infinite Mach number can be fitted by

$$\frac{qV}{kT} = \text{Log} \left(\frac{3}{4} + \frac{r}{\lambda_D} \right)$$

for r/λ_D ranging from 1 to 1000.

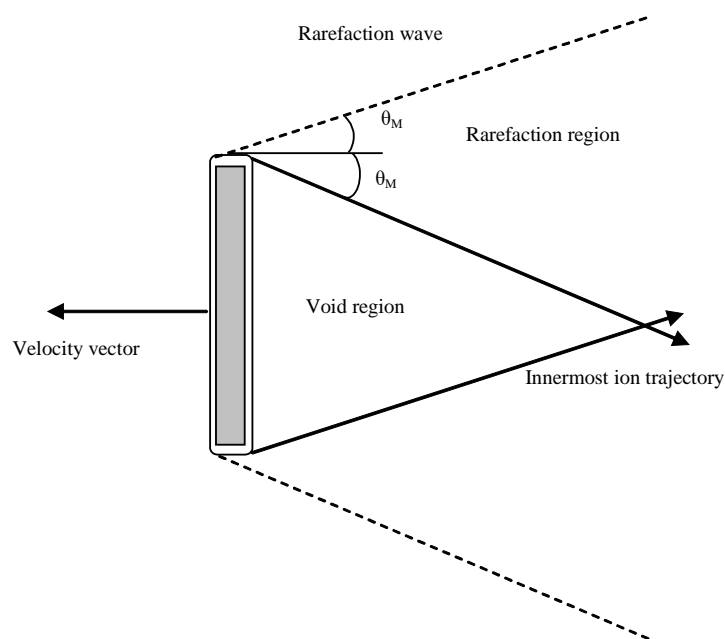

Figure C-4: Schematic diagram of void region

Table C-2: Typical plasma parameters for LEO and GEO

Altitude km	Circular velocity km/s	Ion Acoustic velocity km/s	Mach no.	Mach angle degrees
200	7,8	1,4	5,5	10
500	7,6	2,1	3,7	16
1000	7,3	3,6	2,0	29
1500	7,1	4,3	1,6	38
2000	6,9	5,7	1,2	55
GEO	3,0	30 – 500	0 – 0,1	n/a

a. Adapted from [10].

b. A range of electron temperatures from 2eV to 2keV is estimated for GEO.

C.6.1.2. Effects

It is important to note that the wake effect induces a modified local environment favourable to charging. Because a wake creates a plasma void next to one face of the satellite, there is no low-energy plasma available to neutralize high potentials that can arise. For LEO through the auroral zones, electrons with energies of around 10s keV (described in ECSS-E-ST-10-04) can strike the spacecraft. The ability of such electrons to cause hazardous charging levels is increased by the presence of the wake. This effect can be local, with certain surfaces shielded by booms and other projecting features, due to their orientation relative to the direction of motion.

Wakes present problems to scientific satellites whose goal is to monitor ambient plasma characteristics. When probes enter the wake region near the spacecraft, the plasma they observe is much disturbed.

It is important to note that wakes can be used for extremely pure vacuum applications. NASA has flown the Wake Shield Facility [11] on the Space Shuttle in a proof-of-concept demonstration and it is proposed as a means of generating ultra-pure semiconductors by molecular beam epitaxy and chemical beam epitaxy.

C.6.2 Motion across the magnetic field

C.6.2.1. Induced potential

A difference of potential appears along conductors moving across a magnetic field. For a conductor of length L moving with a velocity vector v in a magnetic field B , the difference of potential V is:

$$V = L(v \times B)$$

For instance a 5 kV potential difference is expected along a 20 km tether in low Earth orbit (which can have applications for power generation).

This potential difference can power a current. The value of both depends on the ability of surfaces at each end to collect ions and electrons. Hence the plasma density and the conductive surface area of the satellites are important. Currents flowing through the plasma along field lines connected to the ionosphere complete the circuit.

C.6.2.2. Current through a long conductor

The current passing through a conductor depends on the geometry of the anode and the cathode and whether they are passive or active. For a spherical probe, electron collection at the positive (anode) end can be approximated using the Alpert Law (see [12]).

$$\frac{i}{i_0} = 1,5 \left(\frac{eV_+}{kT_e} \right)^{6/7} \left(\frac{\lambda_D}{R} \right) \text{ if } \frac{eV_+}{kT_e} > \left(\frac{\lambda_D}{R} \right)^{4/3} \text{ and } i_0 = 4\pi R^2 j_0$$

Here j_0 is the random current of the ambient plasma. Generally, current collection at the anode is not a problem. For the negative (cathode) end, the slower velocity of the ions means that an equivalent collecting area results in a much lower current which does not balance the anode current. Hence, unless a

far larger collection area is available, it is common practice to use electron emitters on the cathode.

C.6.2.3. Force on conductors

When a conductor of length dl having a current passing through it $i(l)$, is moving across a magnetic field B it experiences a force acting perpendicular to the direction of flow of the current tether and to the magnetic field

$$dF = i(l)(dl \times B)$$

Therefore, the total force acting on a tether of length L is given by the equation:

$$F = \int_0^L i(l)(dl \times B)$$

While the electro-dynamic forces act perpendicular to the tether, gravitational and centrifugal forces act along its length and provide a restorative force in the frame of motion of the tether's centre of mass. If the electro-dynamic force varies (e.g. due to varying magnetic field or current collection along the orbit) oscillations can develop. These cause undesired accelerations, stresses on long tether material and the possibility of being caught up on the deployment mechanism or another part of the spacecraft.

When a closed loop is moving across a magnetic field an electromotive potential V appears along the loop.

$$V = -\frac{d\phi}{dt}$$

where Φ is the flux of magnetic field intercepted by the loop.

A loop having a current passing through has a magnetic moment M . The ambient magnetic field exerts a force on M which is

$$F = M\nabla B$$

and a torque T ,

$$T = M \times B$$

C.7 Induced plasmas

C.7.1 Definition

Induced plasmas refer to the plasma environments generated around a spacecraft using active plasma sources. Active plasma most commonly used includes: particle beam emitters for scientific experiments or potential control, plasma contactors and electric propulsion thrusters. The electric propulsion thrusters include: ion engines, hall effect thrusters and field emission electric propulsion engines.

C.7.2 Electric propulsion thrusters

In ion engines the propellant gas, is fed into a discharge chamber where it is ionized by means of electron bombardment interactions. A set of grids located at the end of the chamber then accelerates the positive ions by means of electric fields applied between them. Exhaust velocities of 30 to 50 km/s are achieved on these engines.

The typical Hall thruster (or SPT) has the shape of an axially symmetrical annular shell. The propellant gas is injected into the discharge chamber from the anode side. The electrons emitted by the neutralizer cathode are prevented from streaming directly to the anode by a radial magnetic field. Their resulting azimuthal motion within the discharge chamber provides both the collisions with the neutral gas which form the ionized plasma and the Hall effect which accounts for the ejection of the positive ions at typical speeds of 10 to 20 km/s.

FEEP systems have very high specific impulse (8 000 sec) and high throtability. Clusters of ions are emitted from a spike or an edge on which a strong electric field is set.

Most thrusters use Xenon as a propellant. Some use metallic propellants such as Lithium, Indium or Caesium.

C.7.3 Induced plasma characteristics

The plasma produced by electric propulsion thrusters includes the high energy primary ions of the plasma beam (300 eV for SPT, 1 000 eV for ion engines, 8 000 eV for field emission thrusters), and a low energy charge exchanged ions population (up to a few tens of eV) and neutral atoms.

The emission from thrusters can be classified into the following categories (see [16]):

- **Primary beam ions**

These ions are well focused within the half-angle beam divergence of 10 degrees - 40 degrees. Most thrusters have high ionization efficiencies greater than 95 %. The beam usually consists of singly charged ions, only some percent can be doubly charged (higher percentage in hall effect thrusters). A typical ion beam profile shows a Gaussian distribution, limited by the half-angle divergence.

- **Charge-Exchange ions**

If high-energy primary ions collide with neutral propellant atoms, a charge-exchange collision can occur. During this collision process, the impulse between each collision partner is exchanged, thus creating fast neutrals and slow ions with thermal velocities:

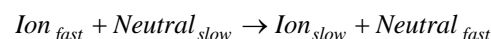

Due to the Gaussian primary ion beam distribution, the beam potential follows also a similar distribution. Slow ions can be repelled from the positive potential along the thruster centreline and create a substantial charge-exchange ion environment around the thruster. Typical charge-exchange ion energies are several eV up to a few tens of eV. These ions are not limited by the primary ions half-angle divergence and thus can

flow towards the spacecraft's surface, solar arrays or other parts. This backflow current does influence spacecraft charging.

- **Neutral atoms**

Since propellant utilization efficiency is less than 100 %, also a neutral environment is produced around the thruster. In case of metal propellants, this can cause substantial contamination concerns, but there is no influence on spacecraft charging until ionization occurs.

Normal plasma characteristics on exit plane of usual electric thrusters are summarized in Table C-3 (see [16]).

Table C-4 (see [15] and [16]) lists order of magnitude of the emission versus backflow currents for various electric propulsion thrusters obtained by particle-in-cell (PIC) computer simulations and consistent with ground based measurements.

The current from the primary emitted particle and the charge exchange plasma overall affect the charging state of the spacecraft. Floating potential values of around -10 Volt in GEO have actually been measured in space experiments using ion thrusters on the SCATHA [17] and ATS-6 spacecraft [18]. A complete spacecraft charging analysis cannot be performed without taking these induced plasma interactions into account.

Table C-3: Plasma conditions on exit plane of several electric propulsion thrusters

	Hall thruster	Ion thruster	FEEP thruster
Application	Telecommunication satellite and primary propulsion	Telecommunication satellite and primary propulsion	Scientific satellites
Exit plasma density	10^{17} m^{-3}	10^{16} m^{-3}	10^{15} m^{-3}
Exit neutral density	10^{17} m^{-3}	10^{18} m^{-3}	10^{10} m^{-3}
Ion energies	300 eV	1 keV	8 keV

Table C-4: Emission versus backflow current magnitudes for several electric propulsion thrusters

Emission	Hall thruster	Ion thruster	FEEP thruster
Emission current	1 A	0,1 A	10^{-4} A
Backflow current	0,01	0,001 A	10^{-12} A
Ratio	1%	< 1%	< 10^{-7} %

C.7.4 Charge-exchange effects

Collision processes between charged and neutral propellant inside the plasma beam of an electric propulsion thruster create low energy propellant ions, so-called charge-exchange ions, which can be reflected by the plasma beam potential towards the satellite surface.

The charge exchange plasma interactions can differ significantly in different ambient plasmas encountered during a mission. The current collected by the spacecraft can create sputtering of surfaces, deposition of contaminant and spacecraft charging concerns.

C.7.5 Neutral particle effects

Contamination of devices such as optical sensors, multi layer insulation blankets, and solar arrays, by deposition of neutral material, is a potential concern when using electric propulsion systems.

C.7.6 Effect on floating potential

Electric propulsion thrusters can eject large fluxes of charged particles. This current leaving the spacecraft has a major effect on the spacecraft floating potential. To counter this effect, such thrusters are operated with neutralizers whose principal function is to produce an equal current of the opposite sign.

C.8 Internal and deep-dielectric charging

C.8.1 Definition

Internal charging (for example, see [19]) refers to the build-up of electric charge, due to particles from the external space environment, anywhere within the spacecraft structure except on its surface. In many cases, this occurs inside dielectrics and is often called deep-dielectric charging. However, internal charging can also occur on electrically isolated conductors within the spacecraft. As with surface charging, this is principally a hazard when high electric fields lead to electrostatic discharge.

As is shown schematically in Figure C-5, electrons from the external environment can be substantially attenuated by spacecraft radiation shielding, if present, before a portion is stopped within a dielectric to produce a current of deposited charge, $J_{deposited}$. This current leads to an accumulation of charge in the material. This gradually builds up an electric field between the area of deposition and the ground plane. This electric field drives a conducted current, $J_{conducted}$, which can be calculated from Ohm's Law, i.e. $E = J_{conducted} / \sigma$. Here E is the electric field and σ is the conductivity. The conducted current is initially small but eventually an equilibrium is established in which the conducted current equals the deposited current, i.e. $E = J_{deposited} / \sigma$. This equilibrium electric field is the maximum i.e. worst-case achievable by the structure in that environment. The magnitude of the equilibrium field depends on both the amount of deposited current and on the conductivity which can be non-uniform throughout the material.

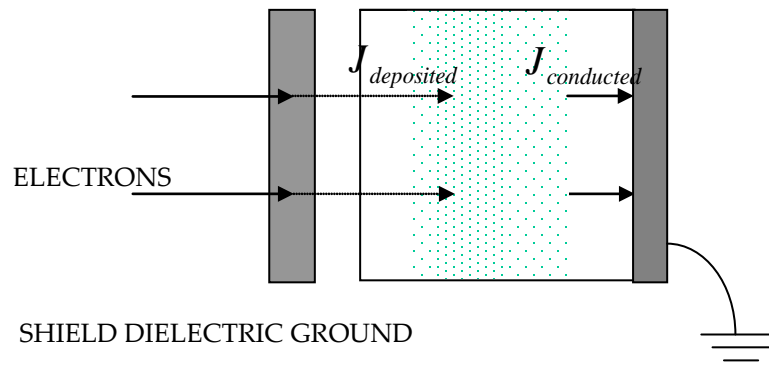

Figure C-5: Schematic diagram of internal charging in a planar dielectric

C.8.2 Relationship to surface charging

The distinction between surface and deep-dielectric charging can, on occasions, be unclear since thick dielectrics on the spacecraft surface are subject to charge deposition over a range of depths. In a general analysis of the problem, the charge build-up near the surface and deeper within the material are both considered together. However, there are practical reasons for treating internal and surface charging separately:

- Surface charging is associated with large currents of a low-energy (~ 10 keV and below) plasma population which usually varies on time-scales of minutes. Secondary and photo-emission are major considerations and are often the dominant currents. The time-scale for charging to occur is usually seconds for absolute charging and minutes for differential charging. These time-scales are associated with the time taken for equilibrium between primary and secondary currents to be achieved and the inter-surface capacitive time-constant. These timescales are generally too short for significant charge to pass through the insulator by internal conduction in dielectric materials. Surface charging typically involves conduction in the outermost micron of the material.
- Internal charging is associated with small currents of a higher-energy ($> 0,1$ MeV) plasma population which usually varies on timescales of hours to days. Photo-emission is not a consideration because the region of interest is not exposed to sunlight. Secondary emission is generally unimportant since secondary emission yields are low at the primary energies concerned. The timescale for charging is often days or longer and is usually determined by the capacitive time-constant across the material. Internally conducted current is a significant contributor to the overall current balance.

Between the energies of surface charging electrons and trapped radiation belt electrons, are electrons that can deposit charges at high rate just below the surface of surface dielectric materials. This can lead to delayed discharges a few hours later.

Surface collected current can, in principle, contribute to the currents flowing within dielectrics and hence to the internal charge state. However, in practice,

on the long time-scales associated with internal charging, surface collected current tends to be neutralized by the other surface currents and hence appears only as an effectively grounded surface, from the point of view of internal charging.

C.8.3 Charge deposition

Internal dielectric charging occurs due to penetrating electrons, generally over 0,1 MeV. These are found in both the inner and outer radiation belt. However, the intensity of the outer belt reaches the highest levels, particularly at higher energies and, in practice, only the outer belt is associated with hazardous levels of internal charging. Although satellites in geostationary orbit are far from the peak of the outer belt, they are subject to continuous exposure and experience a significant risk of internal charging effects. The outer belt is highly dynamic and electron fluxes higher than 2 MeV can rise by two or three orders of magnitude over a period of hours. Such enhancements can persist for several days. There is a solar cycle effect, which means that peak fluxes are usually an order of magnitude higher during the declining phase of the solar cycle than at solar maximum.

Radiation belt electrons penetrate spacecraft surfaces and are deposited within internal materials. Their penetration depth is dependent on their energy and the material properties, particularly density. This can be calculated to good accuracy using Monte Carlo particle transport codes. There are also a number of empirically derived formulae relating range (i.e. penetration depth x material density) to incident electron energy, e.g. Feather (1938) (see [21]), Glendenin & Coryell (1948) (see [22]), Katz and Penfold (1952) (see [23]) and Weber (1964) (see [24]). Comparisons of these formulae (see [20]) showed that they gave very similar results apart from the Feather formula which diverged from the others below about 400 keV i.e. below the energies of main interest.

The formula of Weber giving range (R) as a function of initial electron energy (E) is shown below (E in MeV):

$$R = 0.55.E \cdot \left[1 - \frac{0.9841}{(1 + 3E)} \right] \quad \text{g cm}^{-2}$$

Excellent agreement between this formula and Monte Carlo simulations using the ITS (see [26]) and GEANT (see [27]) codes has been reported (see [25]).

C.8.4 Material conductivity

C.8.4.1. Overview

Electrical conductivity of materials plays a crucial role in determining the level of internal charging in dielectrics. If a charging current is constantly applied, the internal electric field rises only until an equilibrium is achieved, in which deposited and conducted currents are equal. For a layer of material of thickness d , the maximum field at equilibrium, E_{max} , can be found using Ohm's Law:

$$V=IR \text{ i.e. } E_{max} = V/d = (I/A).R \text{ A/d} = j/\sigma$$

where

- V is potential ,
- I is current,
- R is resistance,
- j is current density, and
- σ is conductivity,

since for an area A , $\sigma=d/RA$, and $j=I/A$.

It is an unfortunate complication of internal charging calculations that the conductivities of dielectrics are not constant. They can be strongly affected by temperature, electric field, and radiation. Standard measurement techniques for conductivity have been defined (see [28] and [29]).

C.8.4.2. Temperature dependence

Temperature has a large effect on conductivity in dielectric materials. Higher temperatures increase the energy available to trapped electrons, enabling more of them to jump into conduction band quantum states. Hence conductivity increases with temperature, the reverse of the dependence observed in conductors. The dependence of conductivity on temperature is generally represented by the following equation:

$$\sigma(T) = \sigma_{\infty} \exp\left(-\frac{E_a}{kT}\right)$$

where

- E_a is the material dependent activation energy,
- k is Boltzman's constant,
- T is temperature (K), and
- σ_{∞} is the maximum conductivity as T approaches infinity.

It is important to note that E_a is not the band-gap associated with the excitation of electrons from the valence band into the conduction band which is far larger (for polythene E_a is around 1 eV and the band gap is around 8,8 eV). Clearly a more subtle process is at work than a straightforward excitation of electrons. E_a is found from experimental studies and normally lies close to 1 eV for most dielectrics. Some values were calculated (see [30]) and are listed in Table C-5.

Table C-5: Value of E_a for several materials

Material	E_a
PMMA (perspex)	1,7 eV
Polythene	1,0 eV
Glass	1,3 eV

C.8.4.3. Electric field-induced dependence

Depending on the underlying conduction mechanisms, the electric field-induced dependence of conductivity can vary significantly [51]. Assuming field enhanced conductivity is attributed to the strong electric field causing the activation of additional carriers as well as increasing the mobility of carriers, a convenient analytical model has been proposed by Adamec and Calderwood (A&C, see [31]) in 1975. A&C's model was not significantly different from earlier work carried out in the 1930s, since it yielded almost identical results to that of Onsager (1934) (see [32]) over the whole range of field strengths from the Ohmic region up to the breakdown of the dielectric. The A&C relation between electric field and conductivity is

$$\sigma(E, T) = \sigma(T) \left(\frac{2 + \cosh(\beta_F E^{1/2} / 2kT)}{3} \right) \left(\frac{2kT}{eE\delta} \sinh\left(\frac{eE\delta}{2kT}\right) \right)$$

where

- E is electric field,
- $\beta_F = \sqrt{\frac{e^3}{\pi\epsilon}}$, δ is jump distance (fixed at 10^{-9} m), and
- e is the charge on an electron.

This formula is essentially theoretical, except that δ was chosen to fit experimental data. $\sigma(T)$ concerns the effect of temperature on conductivity discussed in C.8.4.2.

A&C demonstrated a good correlation between their theoretical predictions of conductivity and experimental measurements.

C.8.4.4. Radiation effects

Polymers demonstrate an increase in conductivity under irradiation and this effect has been subject to much experimental investigation. However, most was conducted at very high dose rates by comparison with that seen in space applications. Irradiation excites electrons into the conduction band, generating charge carriers in direct proportion to the energy absorption rate in the polymer i.e. dose rate. This dose rate can be the result of energetic electrons, ions or gamma rays.

The basic equation to describe the conductivity, σ , of irradiated polymers was developed by Fowler (1956) (see [34]). This equation, shown below, is widely used:

$$\sigma = \sigma_o + k_p \dot{D}^\Delta \quad [\Omega^{-1} \text{ cm}^{-1}]$$

where

- σ_o is the dark conductivity [$\Omega^{-1} \text{ cm}^{-1}$],
- k_p is the material-dependant co-efficient of prompt radiation induced conductivity [$\Omega^{-1} \text{ cm}^{-1} \text{ rad}^{-\Delta} \text{ s}^\Delta$], and
- Δ is a dimensionless material-dependent exponent ($\Delta < 1$).

It is generally observed that after irradiation is stopped, RIC decays away only slowly (see [34]). The slow decay of RIC is often called 'delayed' RIC. In some cases a linear dose-dependent permanent increase in conductivity (confusingly sometimes also called delayed conductivity) is also thought to occur. However, this phenomenon seems to be much less well reported and can be restricted to certain polymers which are prone to undergoing permanent changes under irradiation.

Unlike polymers, electrical conductivity in glasses is ionic i.e. current is carried by the migration of ions as in electrolytes rather than by electron-hole pairs. The sodium ion with a relatively high mobility is responsible for the greater part of the conductivity. Irradiation does not seem to be reported to increase conductivity, presumably because it has no effect on the concentration of the sodium ions (see [19]).

C.8.5 Time dependence

For a planar dielectric, the electric field approaches the equilibrium electric field exponentially with time t , i.e.

$$E = \frac{j}{\sigma} \left(1 - \exp \frac{-t}{\tau} \right)$$

where τ is a time constant.

This is the same formula as for a planar capacitor. Where the electrical properties of the dielectric are constant across the material $\tau = \epsilon / \sigma$ where ϵ is the dielectric constant. When the conductivity changes across a sample of thickness x , $\tau = \epsilon \int 1 / \sigma(x) dx$

In the case of a constant conductivity, E_{max} is proportional to the inverse of σ and therefore to τ . This indicates that only materials with long time constants are susceptible to hazardous levels of internal charging. Normally a time constant of 1 day or longer is associated with susceptible materials. τ is effectively the period over which electron fluxes are integrated by the material. Hence 1-day time averages of electron give sufficient temporal resolution when defining a hazardous internal charging environment.

C.8.6 Geometric considerations

Internal charging can be most easily calculated by considering a 1-d planar structure. However, even in this simple case, the conductivity varies across the material due to the changing electric field and radiation induced conductivities. The electric field varies across the dielectric and the maximum electric field in the equilibrium state is found at the boundary between the dielectric and the underlying conductor.

Cable insulators usually exhibit cylindrical symmetry. For a cable with a single central conductor, the cylindrical shape leads to a concentration of current as it flows to the centre. This increases the electric field over the equivalent planar case.

For insulators with a complicated 3-d structure, calculation of the maximum electric field requires both a 3-d model of the charge deposition and a 3-d model

of the currents and electric fields. However, even in this case, the maximum electric field is likely to occur at a dielectric/conductor boundary.

C.8.7 Isolated internal conductors

Conductors cannot support internal electric fields. However, isolated conductors usually have an insulator between them and a grounded surface. In just the same way as for an insulator, the electric field across the insulator rises until sufficient current passes through the insulator to prevent any further increase in field, unless breakdown occurs first.

As with isolated surface conductors, enhanced electric fields result from sharp edges.

C.8.8 Electric field sensitive systems

Internal charging also affects systems where electric fields are being measured sensitively but where components are insulators, semiconductors or electrically isolated conductors.

Triaxial accelerometers and gravimeters represent a uniquely sensitive case of an isolated conductor. In these instruments, acceleration or gravitational pull is usually measured by the force used to maintain a metallic test mass stationary between electrodes e.g. as implemented in the ASTRE accelerometer (see [35]). Alternatively, the test mass can be floating freely, with the spacecraft keeping station around it, as in the forthcoming LISA gravitational astronomy mission (see [37]). Any electrical charging of the mass, due to deposition of penetrating particles produces an additional electrostatic force that is indistinguishable from the acceleration being measured. Some accelerometers have used a fine wire for grounding but this can compromise accuracy. Alternatively, occasional controlled discharging by photoemission, using a UV source, can be conducted. Such an instrument is shielded from penetrating particles in order to minimize internal charging. It is an unusual feature of such systems that it is penetrating ions (>100 MeV) that represent the greatest hazard. Past missions have experienced enhanced charging in LEO when passing through the South Atlantic Anomaly (see [35]) while missions in GEO or interplanetary space can be subject to Solar energetic particle events.

In a similar way micro-electromechanical systems (MEMS) can be affected by radiation-induced electric fields. These systems have electronic and mechanical parts integrated on the same semi-conducting chip. These can include thin insulating layers of e.g. SiO₂ or Si₃N₄. Dose-dependent production of electron-hole pairs can lead to charge trapping in the dielectric. These layers are too thin for the electric fields in them to approach breakdown levels. Nevertheless, for some applications, smaller fields can have serious consequences on performance. In one study (see [36]) a certain 1-d MEMS accelerometer was shown to exhibit spurious measurements under proton irradiation of its mechanical part. A similar device, in which the dielectric layer was electrically shielded by a conductor did not experience the same problem.

C.9 Discharges and transients

C.9.1 General definition

Electrostatic discharge is a single, fast, high current transfer of electrostatic charge that results from :

- Direct contact transfer between two objects at different potential, (this is the case for human ESD), *or*
- A high electrostatic field between two objects when they are in close proximity (this is the case for ESD on spacecraft, in space).

Surface charging induced electrostatic discharge refers to the dynamic electronic current which leads to surface potential neutralization after the build-up of electric charge that occurs on exposed surfaces, due to particles from the external space environment, anywhere within or outside the spacecraft structure on exposed surfaces. Discharges can occur both on dielectrics (called surface-dielectric discharges or normal gradient electrostatic discharges) and also on conductors within or outside the spacecraft (called inverted voltage gradient discharge or metallic discharge). These are responsible for major hazards associated with satellite surface charging.

Similarly, internal charging induced electrostatic discharge lead to complete or partial neutralization of electric fields inside dielectrics or on internal conductors.

C.9.2 Review of the process

The flow of charged particles from space hitting the satellite tends to charge it to an absolute value in relation to its environment and differentially between its parts.

When the configuration of the field or of the potential becomes critical, at the surface of the satellite, electrostatic discharges can occur either into space by electronic blow-off (expansion of electronic space charge), or differentially between several parts of the satellite.

The most immediate effect is the direct injection of large transient currents into electronic circuits or the indirect production of transient currents through electromagnetic coupling of the emitted electromagnetic pulses on satellite parts (e.g. cables and circuits). This can result in losses of system availability. Additionally, breakdown can cause a permanent change in the material properties which can cause the material to be degraded as an insulator.

A typical ESD induced spacecraft anomaly scenario is as follows:

- immersion of a satellite in plasma with energy above 10 keV;
- differential charging of various parts of the satellite;
- exceeding a critical threshold generating the activation and propagation of a discharge in vacuum;
- generation of an electromagnetic field impulse and induction of current in the satellite structure;

- creation of a potential difference at the entrance of a circuit exceeding its susceptibility threshold.

C.9.3 Dielectric material discharge.

C.9.3.1. General

Dielectric material discharge deals with the case when, during a breakdown, the electrons come from a charged dielectric.

C.9.3.2. Punch through

Punch through is the classic breakdown of a dielectric material, a phenomenon which can occur in the breakdown of a capacitance, for example. For surface charging, the material is pierced right through its depth, the charges accumulated on either side of the surface recombining by this path.

C.9.3.3. Flash-over

Flash-over is a surface discharge which is propagated from a starting point. The surface of the dielectric becomes conductive (by creation of a plasma), and the discharge current closes in on the closest electric ground (metallization of the dielectric in most of the cases). The surface discharge current returns to ground by the edge of the material.

C.9.3.4. Blow-off

Blow-off concerns the emission of negative charges (electrons) into space. These emitted electrons can reach a satellite electric ground, far away from the emission site. The phenomenon occurs simultaneously with the flash-over and is proportionally linked to it.

C.9.3.5. Discharge theory

At first, the dielectric undergoing the bombardment of the electrons coming from the plasma "traps" some of them inside the material very close to the surface. These electrons accumulate in trap sites, forming a negative layer in the material. The accumulation of these electrons over a length of time generates intense electric fields inside the dielectric which can lead to the appearance of the punch through phenomenon. The flash-over and blow-off phenomena then begin to occur as illustrated schematically in Figure C-6.

The propagation of the discharge requires a transverse field (parallel to the surface of the material) and a desorbed gas.

This gas can be supplied during the punch through. Indeed, at punch through, the energy released inside the material raises the temperature of this material, causing a conductive plasma to appear.

Under the effect of the transverse field, a neutral atom is separated into an ion and an electron. The electron rejoins the surrounding ground and the ion compensates the electronic charge by settling on the surface of the dielectric

thus desorbing an atom. This atom is in turn ionized and the process can be repeated until total compensation of the charges.

The discharge is thus propagated over the entire surface of the dielectric like a bush fire.

The discharge therefore leaves behind a double layer which takes tens of minutes to neutralize.

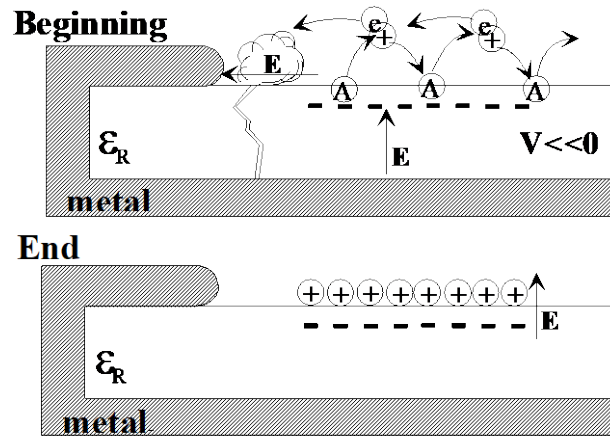

Figure C-6: Dielectric discharge mechanism.

While flash-over takes place, the blow-off phenomenon appears. In contrast to flash-over, which is a purely local phenomenon, and which consequently cannot create a current outside the dielectric, the electrons issued from blow-off follow settle on the surrounding structures where they then circulate. Blow-off electrons generate discernible and measurable currents. The positive image charges found in the metallization of the dielectric support is neutralized by a current of electrons which travels from the satellite structure towards the metallization of the dielectric: it is an electrostatic re-equilibrating current

As shown in Figure C-7, the discharge starts at a point in the sample generally having a defect, and then moves away radially from this point. The circular discharge edge mobilizes an increasingly large part of the sample until it reaches the edges. At that moment, the discharge current decreases.

Discharge propagation starting from coordinates(3,3)

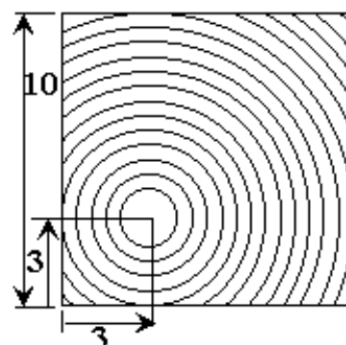

Figure C-7:Shape of the current in relation to discharge starting point.

The discharges that generally last several hundred nanoseconds, have amplitudes of around 1000 amps per linear metre of discharge and raising edges of 10^6 to 10^8 A/s, this data varying, as we have just seen, according to the materials, to their size, to their shape and to the starting point of the discharge. An example of a discharge wave-form is shown in Figure C-8.

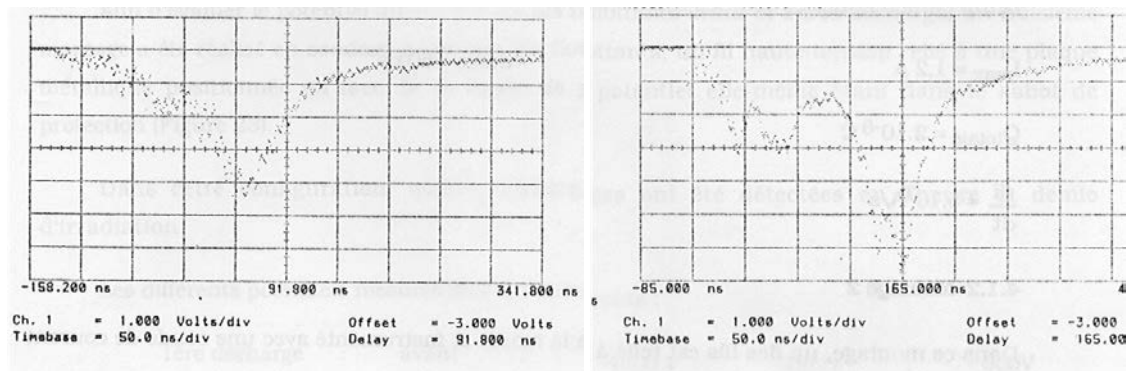

Figure C-8 : Example of discharge on pierced aluminized Teflon® irradiated by electrons with energies ranging from 0 to 220 keV.

C.9.4 Metallic discharge

C.9.4.1. Metallic discharge: grounded conductor

A criterion of metallic discharges is: discharge can occur if dielectric surface voltage are greater than 100 V positive relative to an adjacent exposed conductor. If a conductor is at the frame potential, this condition can only be attained when the spacecraft ground is negative with respect to space.

When the voltage of a conductor exceeds some hundred of volts, if the curvature radius is small enough, the electric field on the tip is sufficient to generate field emission (also called *cold emission* or *Fowler-Nordheim emission*). The electron is driven towards the relatively positive dielectric area with energy near the maximum secondary emission yield (Figure C-9). If the general configuration of the electric field provides trajectories to infinity, secondary electrons are blown off. For a yield larger than 1, the dielectric region is left more positively charged than before, which increases the electric field and field emission capability. So, the process avalanches only limited by the fusion of the tip, when heated by the increasing current density.

The discharge is interrupted when there is no more available charge on the conductor. In the case of a grounded conductor, the charge released is the total absolute spacecraft charge.

A typical current measured in the laboratory is in the 10 mA-1 A range. The discharge of a spacecraft frame can takes several microseconds.

C.9.4.2. Metallic discharge: floating conductor

The field configuration is identical to the grounded conductor case but the spacecraft potential can be zero. When a metallic component is let floating, differential secondary emission yields can render it negative with respect to

surrounding dielectrics. If the differential voltage reaches the hazard threshold of about 100 V, arcing becomes possible (Figure C-9) with the same process as for grounded conductors.

This process is known as the "inverted gradient discharge" since the metal is negative with respect to dielectric in opposition with the "normal" gradient where the dielectric surface is negative with respect to the spacecraft frame.

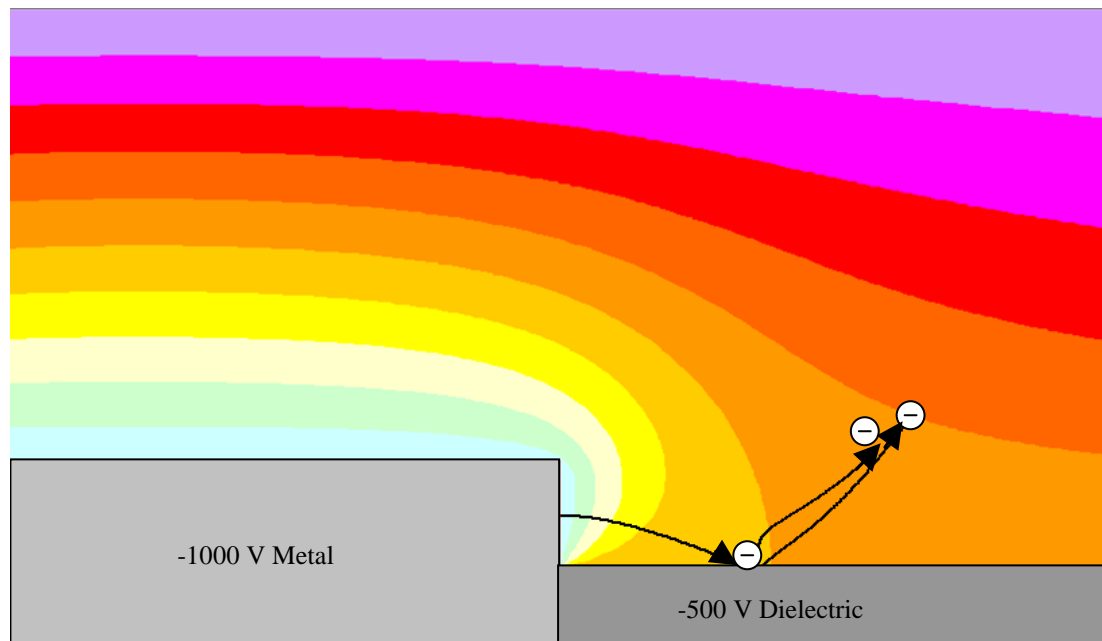

NOTE: Electrons emitted by the metal near the triple point are attracted to the adjacent dielectric. Secondary electrons may be released with yield greater than 1, further increasing the difference in potentials.

Figure C-9: Schematic diagram of discharge at a triple point in the inverted voltage gradient configuration with potential contours indicated by colour scale.

C.9.5 Internal dielectric discharge

In internally charged dielectrics, dielectric break-down (punch-through) occurs but does not generally penetrate fully through the material. Instead, it begins at a grounded point and fans out into the material, neutralising areas of high electric field. These discharges characteristically produce a 'tree'-shaped discharge path called a Lichtenberg pattern.

Published breakdown electric fields for dielectrics are typically close to 10^7V/m . However, in laboratory experiments (see [20]) pulsing has been observed at lower macroscopic field strengths (10^6V/m), perhaps due to local microscopic field concentration.

Whilst the most immediate consequence is the production of transient currents through direct injection or electromagnetic coupling, breakdown can also cause a permanent change in the material properties which can cause the material to be degraded as an insulator.

C.9.6 Secondary powered discharge

C.9.6.1. General

Electrostatic discharges can become sustained by being fed from power sources on the spacecraft. This leads to an important additional damage mechanism since the power source can become permanently short-circuited. Systems affected include high power solar arrays and motors such as those which drive solar arrays.

C.9.6.2. Primary discharge

The discharge which is called “primary discharge” is the initial phenomenon that leads to an arc by creating a temporary conductive path (generally it is an expanding plasma bubble) instead of vacuum between two electrodes (polarized conductive parts).

C.9.6.3. Secondary arc

The arc which leads to the term “secondary arcing” is the resulting phenomenon; the current which passes through the conductive path created by the primary discharge.

This secondary arc is powered by an external source (for instance an illuminated solar array). Each time a primary discharge occurs where a secondary arc can occur, this secondary arc forms (a current flow through the temporary conductive path). The secondary arc can have several possible forms:

- A non-sustained arc is a secondary arc that lasts only during the primary discharge including the flash-over. It extinguish when the primary discharge stops.
- A self sustained arc is a secondary arc that lasts longer than the primary discharge.
- A temporary self sustained arc is self sustained but it stops by itself even though the external power is still available.
- A permanent self sustained arc is an arc that does not stop while the external power is available. A possible outcome of this type of arc, if the external power is not quickly removed is that the intense current heat in the vicinity of the secondary arc creates a very highly conductive path by pyrolizing materials around the discharge site. When this conductive path is created, power is diverted from the arc and the arcing site cools. A stable permanent short circuit can remain through the pyrolized material.

C.9.7 Discharge thresholds

Discharge or breakdown occurs when the stress due to electric force exceeds the cohesion force in the material. Normally the threshold electric field is of the order of 10^7 V/m between a dielectric element and a metallic element (see [38]). In practice failures occur on microscopic scale surfaces like edges, spikes where electric fields are the strongest but difficult to measure or to estimate. Therefore,

empirical criteria based on more macroscopic potential measurements are generally used.

Because the microscopic fields depend on the structure of the material, the macroscopic potential at which discharge is observed can depend on sample geometry, type of discharge, environment, material properties and surface state. Inverted voltage gradient discharges have been observed to start when potential differences of over 100 volts are applied.

For a dielectric adjacent to a more positive metal (normal potential gradient), the critical voltage is around 1kV. Electric fields of 10^6 to 10^7 V/m normally lead to ESD but the discharge does not propagate along the surface (i.e. lead to flash-over) without a substantial transverse electric field and so surface potentials of greater than 1kV are an additional characteristics for these discharges. Discharges initiated by the dense plasma environment in low Earth orbit can occur with potential differences above around 100V (see [7]).

Annex D (informative)

Charging simulation

D.1 Surface charging codes

D.1.1 Introduction

D.1.1.1. Overview

Charging simulations are used to find the charging state of surface materials, the spacecraft ground and the differential potentials that exist. These simulations are useful only if they are able to realistically represent the main charging currents, primary electrons, primary ions, photo-emission, secondary emission and conduction. Because of this, good material parameters (especially photo-emission and secondary yields) are necessary inputs. For initial assessments, simple 1-d codes are useful but a realistically simulation cannot be made without considering geometrical effects on field distributions and so 3-D codes are used.

There are a number of simulation codes available for performing surface charging assessments taking into account surface material processes and 3D effects. Historically the most common spacecraft charging code in use by the space industry was the NASA-USAF charging analysis code, NASCAP-GEO.

Recently, ESA has sponsored the development of several modelling codes, Equipot, PicUp3D, SPIS which are publicly available for all users and therefore well suited for being used on standard basis. The SPARCS (SPAcceRaft Charging Software) is also suitable.

D.1.1.2. Equipot

A simple charging code, called EQUIPOT [40] performs computations assuming either thick-sheath or thin-sheath current collection and is thus applicable to GEO and LEO charging. It allows to estimate the differential charging expected between a dielectric patch and the ground structure. It includes a list of material properties. It can be run over internet on <http://www.spervis.oma.be/>

D.1.1.3. PicUp3D

PicUp3D is a fully 3D PIC code that allows the exact computation of the sheath structure and of the current collected by spacecraft surfaces for rather detailed geometries. Surface interactions other than photo-electron emission are not

modelled. The code source is freely available from www.spis.org and a mailing list allows a limited amount of support.

D.1.1.4. SPIS

SPIS is a fully 3D PIC code that allows the exact computation of the sheath structure and the current collected by spacecraft surfaces for very detailed geometries. A large class of surface interactions including (photo-electron emission, back-scattering, secondary-electron emission and conduction) are modelled. In terms of modelling capabilities it largely supersedes NASCAP-GEO, LEO and POLAR. The code source is freely available from www.spis.org and a mailing list allows a limited amount of support.

D.1.1.5. NASCAP Family of Charging Codes

D.1.1.5.1 NASCAP-GEO

A commonly used code, for simulating surface charging in the outer magnetosphere, is NASCAP (also called NASCAP-GEO [41]). This code calculates the total current, due to all the current contributions, for each surface on a numerically modelled 3-d spacecraft, using a two Maxwellian environment for both ions and electrons. From these currents, the change in potential at each surface is calculated. The current and potential calculations can be performed iteratively until an equilibrium charging state is achieved. The NASCAP-GEO spacecraft geometric definition is quite coarse, consisting mainly of blocks .

D.1.1.5.2 MATCHG

Where spacecraft geometry is unimportant because all that is relevant is the susceptibility of a particular material to charging in a particular environment, then a simple 1-D code, MATCHG [41], based on a subset of NASCAP subroutines, can be used. Current collection in both codes is determined using the 'thick sheath' approximation i.e. assuming that the Debye length is long compared to the spacecraft dimensions. This approach is valid at GEO but for charging in low-altitude auroral conditions a different approach is used.

D.1.1.5.3 NASCAP-LEO

NASCAP-LEO is aimed at the simulation of high potential objects with cold dense plasma typical of the LEO environment. Like NASCAP-GEO it employs analytical current collection equations, although these are aimed at sheath-limited current collection that is appropriate for the short Debye-length LEO plasmas. A typical use is the simulation of parasitic currents from high potential surfaces, such as solar array interconnects.

The geometrical model of the spacecraft is more sophisticated than for NASCAP-GEO, consisting of a finite-element representation. However, NASCAP-LEO does not simulate the spacecraft sheath with any great accuracy and hence for problems which involve sheaths and wake effects, e.g. natural charging, it is not well suited.

D.1.1.5.4 NASCAP-2K

The most recent NASCAP code (NASCAP-2K) is available, free, to US citizens only. This is a comprehensive code with realistic geometry. It is reported to

combine the capabilities of NASCAP-GEO, NASCAP-LEO and POLAR which are discussed later. However, since the code is not easily available in Europe, its capabilities are not discussed further.

D.1.1.6. POLAR charging code

The main problem with computing charging in LEO is computing effects associated with the spacecraft sheath. The 3-D POLAR code [42] has been designed for assessment of sheath and wake effects on Polar orbiting spacecraft. This uses numerical techniques to track ambient ions inwards from the electrostatic sheath surrounding a negatively charged spacecraft, onto the spacecraft surface. Spacecraft velocity is included as an input and ram and wake effects are modelled. One or two Maxwellian components can be used to define the ambient plasma. The electron population in POLAR is a superposition of power-law, Maxwellian, and Gaussian components. Once the surface currents have been found, POLAR calculates potentials and equilibrium charging state in a similar way to NASCAP.

D.1.1.7. Other surface charging codes

There are a number of other codes available to simulate surface charging. Two Russian codes ECO-M [43] and COULOMB [43] perform a very similar function to NASCAP and POLAR and NASCAP-LEO.

D.2 Internal charging codes

D.2.1 DICTAT

DICTAT is a 1-d code that uses analytical current transport equations to determine the current deposited in a shielded or unshielded dielectric. From this, it uses the conductivity of the material to determine the maximum electric field within it. Conductivity varies as a result of changing temperature and applied dose rate and so DICTAT simulates this variation in a consistent manner. DICTAT can be run interactively via the SPENVIS website (www.spervis.oma.be/spervis/). This web site also describes the code in more detail.

D.2.2 ESADDC

ESADDC [44] is a 1-d charging code that uses a 1-d Monte Carlo particle interaction code to describe electron and proton transport through radiation shielding and dielectrics. The dielectric structure is usually divided into many zones which are capacitively and resistively coupled. Hence the code provides electric fields that are spatially and time-dependent, for a constant environment.

D.2.3 GEANT-4

GEANT-4 [48] is a 3-d Monte Carlo Radiation transport toolkit. From this, calculations of deposited charge as well as dose **can** be performed in 3-d. These currents and doses **can** be used as input to an internal charging analysis that takes into account the bulk and radiation-induced conductivity of the materials concerned.

D.2.4 NOVICE

NOVICE [47] is a commercial 3-d Monte Carlo Radiation transport code. As with GEANT-4, simulated currents and doses **can** be used as input to an internal charging analysis.

D.3 Environment model for internal charging

D.3.1 FLUMIC

FLUMIC (Flux Model for Internal Charging) gives an appropriate severe internal charging environment for use in internal charging assessments. This model is integral to the DICTAT internal charging tool but **can** be applied separately. FLUMIC describes the electron flux, which has an exponential dependence on energy E and varies with L , time of year and phase of the solar cycle. FLUMIC version 1 and 2 covered L-shells above 2,8, i.e. the outer belt only. The exponential spectrum were derived from flux measurements of electron with energy higher than 1 MeV. It can a priori be extrapolated down to lower energy (say a few 100 keV), although for more dynamics lower energy environment more sophisticated models are used. Version 2 is currently implemented via DICTAT on the SPENVIS web service. Recently, version 3 has been created. This is broadly similar to FLUMIC version 2 in the outer belt because it is based on the same data. However, it also models electron fluxes in the inner belt.

D.3.2 Worst case GEO spectrum

Based on an analysis of anomalously large electron enhancements, a worst case spectrum for GEO was described [46]. For geostationary orbit only, as a supplement to the above FLUMIC model, a worst-case geostationary environment can be treated by the substitution of the following two equations:

$$F(> E) = F_R \exp((2 - E) / E_0)$$

$$F_R = 6 \times 10^9 \text{ cm}^{-2} \text{ day}^{-1} \text{ sr}^{-1}$$

$$E_0 = 0,63 \pm 0,08 \text{ MeV}$$

The NASA handbook [19] presents a different worst case environment in graphical form. It appears to be slightly harsher than the above presumably because it is based upon a single spectrum from measurements taken on 11 May 1992 over only a few hours at a selected longitude.

Annex E (informative)

Testing and measurement.

E.1 Definition of symbols

In equations used in this clause, the following definitions of common symbols can be assumed, if not stated in the text:

σ – conductivity $\Omega^{-1} \text{ m}^{-1}$.

t – time in seconds

V – potential in Volts

ϵ , ϵ_0 , ϵ_r - dielectric constant, dielectric constant in vacuum, relative dielectric constant

C – capacitance

A – area

ω – angular frequency

E.2 Solar array testing

E.2.1 Solar cell sample

It is generally impractical to simulate a complete solar array. Hence a smaller sample, or coupon is generally used. An example of a coupon used for testing of a solar array is shown in Figure E-1.

The spacing between the cells is an important parameter but it is not constant as the assembly is done manually. It has been measured on the sample at various locations and is generally between 800 μm and 900 μm . The minimum used on the real solar array tested in the coupon.

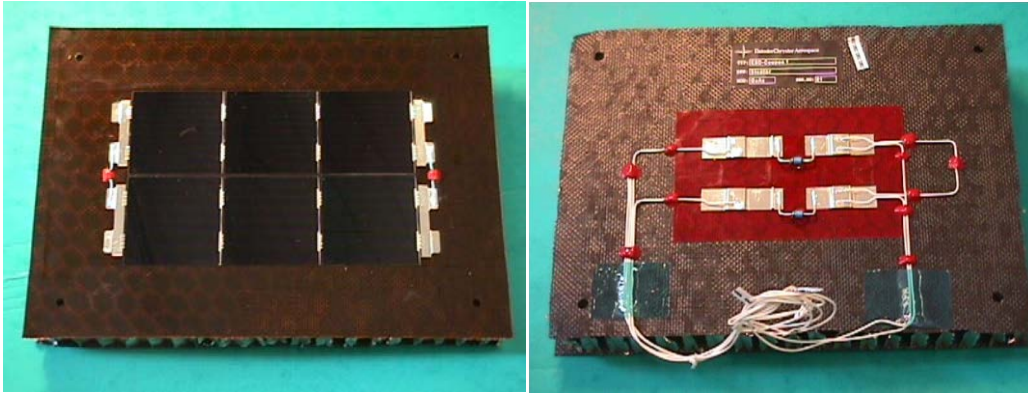

Figure E-1: Photograph of solar cells sample – Front face & Rear face (Stentor Sample. Picture from Denis Payan - CNES®).

E.2.2 Pre-testing of the solar array simulator (SAS)

E.2.2.1. General

The coupon alone does not display the same electrical response as a whole solar array. Hence a circuit, called a solar array simulator is set up. A solar array simulator is able to reproduce the dynamic response of an illuminated solar array to transient short-circuits between cells. This particularly requires that high current can be supplied as soon as a short-circuit occurs.

It is intended that the dynamic response of the solar array simulator is the same as the string response during the first microsecond. The quality of the solar array is evaluated with a specific test set-up. To test the time response of the various power supplies, the test set-up below can be used.

The test is performed with the same wire length as used during the solar array test or, better yet, directly in the vacuum chamber just before making the test. The real set-up is used and the real slope of the transient is known. It is suggested to start always with this kind of test to evaluate the effect of the set-up on the transient response of the solar array.

To evaluate only the power supply, a test can be done with a set-up with wire length as short as possible. The success criterion is achieved when the transition is made in less than one microsecond.

The test procedure is as follows (see Figure E-2):

- The power supply voltage is adjusted to 50 V and the current limited to 3 A. The current flowing through the 50 Ω impedance is equal to 1 A.
- The 50 Ω impedance is suddenly short-circuited with a 1 Ω impedance (using a mercury switch to avoid rebound). The power supplies then switch from voltage limitation state to current state. We therefore see the current pass from 1 A to 3 A.
- Wire length is chosen so that total inductance does not exceed 1 μH . If the wires are too long, the maximum rise slope that can be measured is fixed by their length and the real rise time of the power supply is not achieved.

- Only a power supply with very low output capacitance is used. If this is not possible, an electronic current regulator is used to conceal the capacitance.

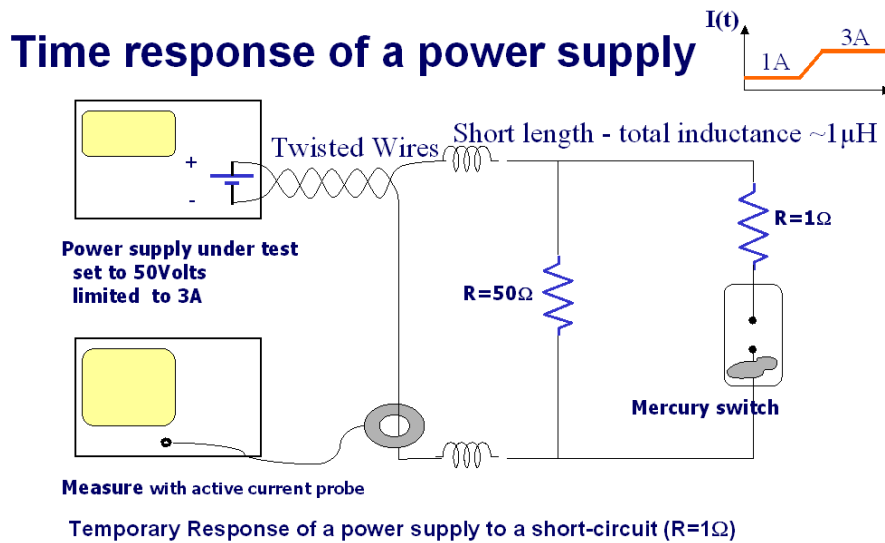

Figure E-2: Schematic diagram of power supply test circuit

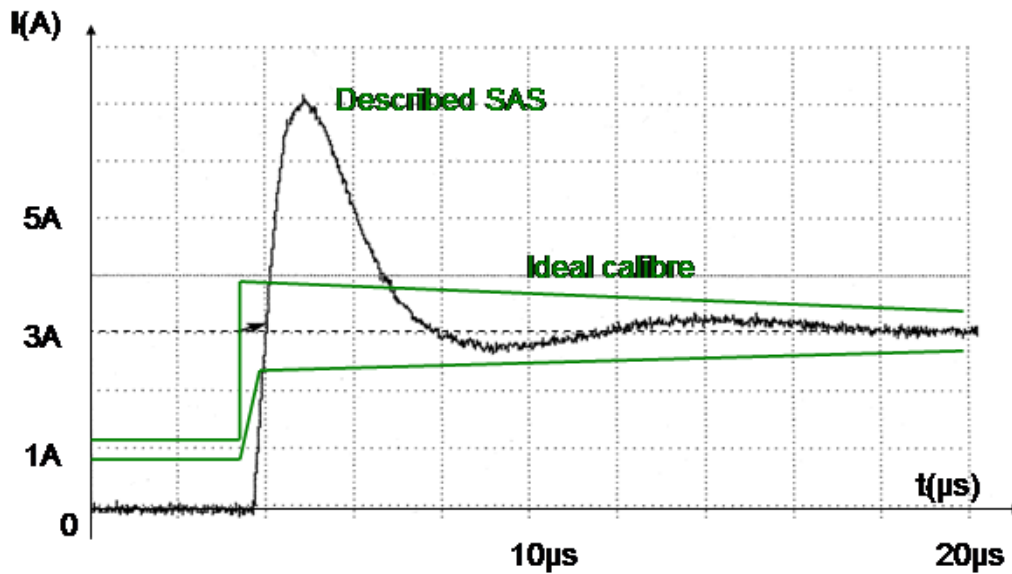

Figure E-3: Example of a measured power source switch response

E.2.2.2. Example SAS

Any SAS that meets the success criteria can be used. The description in Figure E-4 is given as an example. This SAS set-up allows us to choose both the voltage between the two end cells of a string and the current through the cells.

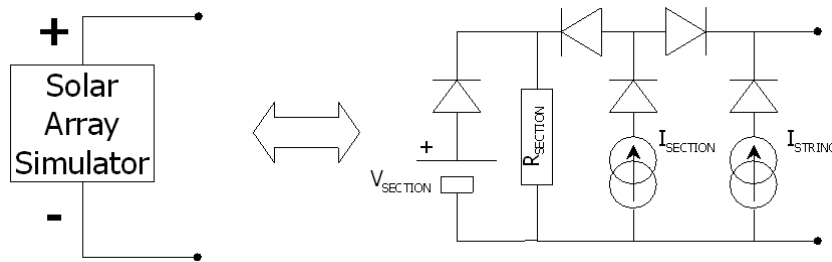

Figure E-4: Example solar array simulator

E.2.3 Solar array test procedure

E.2.3.1. Preliminary set-up

The set-up includes the following steps:

- Coupon preparation
- The solar cells' current-voltage (I,V) characteristic are measured with the help of standardized flasher tests. Visual inspection and electrical continuity control are achieved.
- The gap sizes between the strings are measured.

E.2.3.2. Test on polarized solar array coupon in vacuum

The following is a description of the test for the inverted voltage situation with electron irradiation. When another method is used, this procedure is modified consequently.

- Out-gas the coupon in the best possible vacuum ($< 10^{-6}$ mbar) for 10 or 12 hours.
- Apply the bias (-5 kV) to the coupon structure with a power supply through a resistor of 100 M Ω .
- Verify that no discharge appears (with the help of Pearson probes and video recording).
- Irradiate the coupon (solar cell side) with 8 keV electrons at low current density (few tens of pA/cm²) to obtain the inverted voltage gradient until primary discharges appears. (Other triggering methods are possible.)
- Verify that at least 5 primary discharges occur in the intercell gap.
- After exposure, verify that all strings are isolated from each other and from the structure (nominal resistance is > 1 M Ω).
- Power the solar cell string with an ESD representative Solar Array Simulator at nominal interstring voltage and nominal string current, including margin and the switching transients (overshoot) due to the operation of the power regulator.
- Record a few typical discharge signatures (I(t), V(t)).

E.2.3.3. Success criteria

The success criteria for testing are the following:

- Success in the standardized flasher test.
- Success of electrical continuity checks.
- Success of electrical insulation checks.
- Success of visual inspection (no visible degradation)

NOTE It is important to pay attention to the heating of the cells. It is generally not feasible to bias the cell strings with the nominal current, so a low current source should be used for voltage biasing.

E.2.3.4. Electrical parameters of the coupon

All the following electrical parameters of the solar array string in its environment are carefully determined and simulated on the coupon.

- String and section voltages.
- String and section currents.
- Solar array absolute bias voltage (-5 kV worst case for geostationary orbit).
- Spacecraft absolute capacitance C_{sat} (see .Figure E-5)
This is the capacitance of the satellite structure to infinity. On the geostationary orbit 200 pF is a typical value.

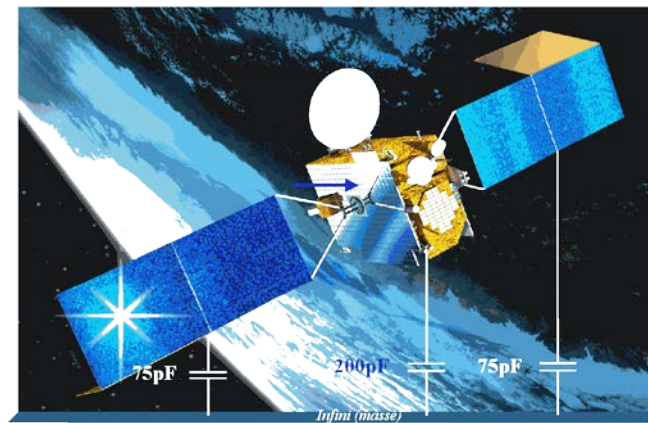

Figure E-5: Absolute capacitance of the satellite

- Solar array absolute capacitance C_{SA} .
This is the capacitance of the panel structure to infinity. On the geostationary orbit 100 pF is a typical value.
It is known today that the satellite capacitance plays a role of prime importance in the ignition of the inverted voltage gradient discharge and that its value is low (typically 300 pF). It is also know that the representativity is achieved by taking into account the true capacitance value of the satellite without adding the coverglasses capacitance in parallel to it. It can lead to false transient response.

- Structure-string capacitance: common mode capacitance measured between the short circuited solar cell string and the solar panel structure.
- For Kapton capacitance C_k for one cell (typical value $C_k/\text{Area}=15$ to 30 pF/cm²) deduced from the following formula

$$C_k = \epsilon_0 \epsilon_r \cdot \frac{A}{d} \quad \text{for area } A \text{ and thickness } d.$$

To get to the right value, the best solution is by network analyser measurements.

- For the capacitance through the Kapton for the missing cells ($C_{\text{string com}}$), the capacitance between the string and the structure through the Kapton is evaluated. $C_{\text{string com}}$ is chosen at its highest possible value which is $C_{\text{String com}} = N_p \cdot N_s \cdot C_k$, where N_s is the number of cells per string and N_p is the number of strings in parallel.
- String capacitance: differential mode between the two ends of the string. The capacitance of the missing cells chain is simulated by only one capacitance between the (+) and the (-) wires. In the case of a floating solar array structure (during fast transients, when there is a bleeder resistor), we can approximate the impedance of the SA by a capacitance:

$$C_{\text{String}}(V_s) = \frac{1}{2} \cdot \frac{\sqrt{C_k \cdot C_j(v)}}{\text{th} \left(\frac{N_s}{2} \cdot \sqrt{\frac{C_k}{C_j(v)}} \right)}$$

C_k = Capacitance through the kapton fo one cell

C_j = Junction capacitance for one cell

V_s = String voltage

$$v = \text{Cell voltage} = \frac{V_s}{N_s}$$

N_s = number of cells for one string

It is important to take the right value of the Cell junction capacitance due to its non-linearity (estimation of the capacitance for voltage values between 0 and V_{nominal} , see Figure E-6).

$$C_j(v) = C_{\text{Transition}} + C_{\text{Diffusion}}$$

$$300\text{nF} \langle C_{\text{Transition}} \langle \text{some } \mu\text{F}$$

$$\text{some } \mu\text{F} \langle C_{\text{Diffusion}} \langle \text{some hundreds } \mu\text{F}$$

GaAs Cell Si Cell

For high value of C_j , (Si cells near V_{oc} : open circuit voltage)

$$\frac{N_s}{2} \cdot \sqrt{\frac{C_j}{C_k(v)}} \langle 1 \text{ then, } \boxed{C_{\text{string diff}} \approx \frac{C_j(v)}{N_s}}$$

As there are about one hundred cells per string, you have $C_c \rangle 2500 C_s$.

This is the case when $C_{\text{String Com}}$ is negligible, the equivalent capacitance of

a whole string corresponds to the capacitances of each cell (C_c) in series.

For low value of C_j , $\frac{N_s}{2} \cdot \sqrt{\frac{C_j}{C_k(v)}} > 1$ then $C_{string\ diff} \approx \frac{1}{2} \cdot \sqrt{C_j(v) \cdot C_k}$

Most of the time, the C_j value is intermediate and therefore the complete equation for the capacitance is used.

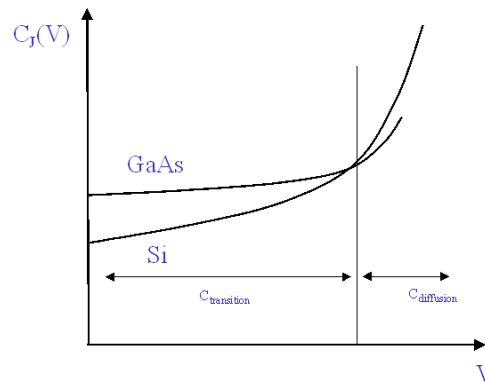

Figure E-6: Junction capacitance of a cell versus to voltage

- String inductance. The capacitances are put as close of the coupon as possible (on the rear face of the coupon inside the vacuum chamber), connected to the cells with simple wires. The length of those wires simulate the whole string impedance whose typical value is below 1 μ H (which authorizes a length of around 1 m).
- The capacitance of the cover-glass. Coverglass capacitance is capacitance measured between the front face of the cell and the front face of the coverglass. This capacitance is not taken into account in the calculation of the spacecraft capacitance.

$C_\varepsilon = \varepsilon_0 \varepsilon_r \cdot \frac{A}{d}$ where A and d are the area and thickness of the coverglass respectively.

This capacitance is evaluated for each coverglass. In fact it is hard to insert it in the test set-up. It is important to note that this capacitance cannot be added to the satellite capacitance. A metallic electrode cannot be used, and a large enough dielectric is used for the tests. The best solution seems to use a power source between the “+” wire and an electrode beyond the cell. This source delivers an equivalent current to the flashover current to that delivered if the coverglass were neutralized.

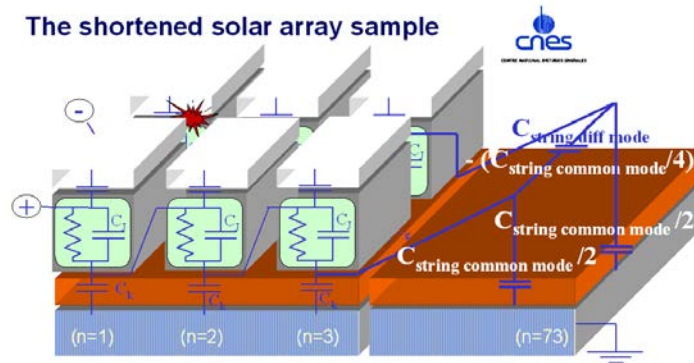

Figure E-7: The shortened solar array sample and the missing capacitances

E.2.4 Other elements

To be realistic the inductance and the resistance of the string is taken into account as follows.

- Inductance. All connecting wires used in the test set-up set inductances, which slow down rise time of current available for the secondary arcing. It is important that they are representative of the flight configuration.
- Resistances effects. The insertion of a serial resistance, during laboratory tests, in the loop of the secondary arcing allows sustaining the arc. It avoids under damping in the oscillating circuit and consequently avoids stopping the secondary arcing. (Its increase R with respect to L). However, to obtain a representative simulation of the flight configuration, it is important that this resistance is carefully chosen in order to have realistic behaviour.

In the real case, there are two serial resistances; the arc resistance (value is typically some Ohms) and the string serial resistance whose value is lower. In fact, without any more information we consider that it is better not to add any resistance and let the arc develop its own resistance. When the string dumping conditions are well known, they can be simulated by inserting a pertinent serial resistance.

The following lines describe the effect of total resistance R on the sustaining conditions. Z is impedance, L is inductance and C is capacitance.

Over damping condition exists if

$$R_{TOTAL} = R_{Added} + R_{ARC} > 2\sqrt{\frac{L}{C}}$$

If there is an added resistance to the discharging circuit, it also affects the operating point on the discharge curve.

In conclusion, it is important to let the arc disconnect if it is realistic.

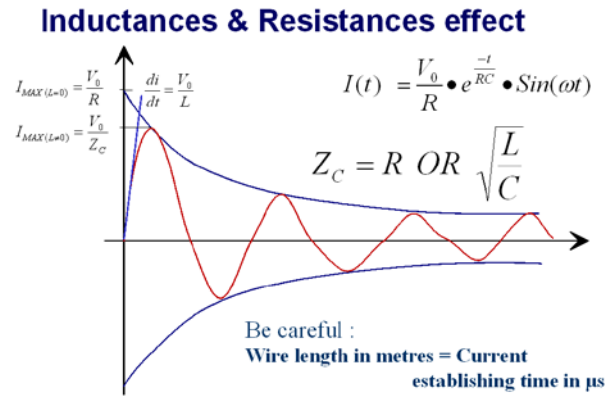

Figure E-8: Discharging circuit oscillations

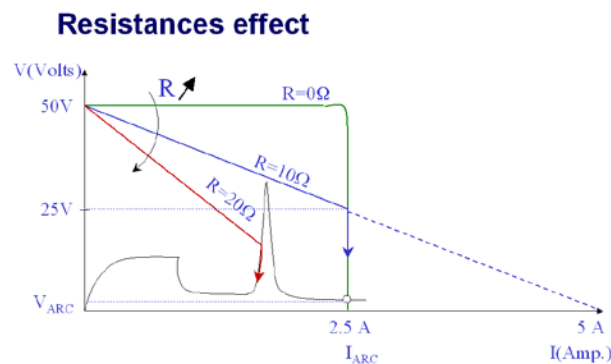

Figure E-9: Effect of an added resistance in the discharging circuit (SAS + resistance)

E.2.5 The solar panel simulation device

E.2.5.1. The test set-up

The complete test set-up is as follows.

With such a device, it was feasible to conduct electrostatic discharge tests in normal situation (the sample structure is connected to the ground and the dielectrics are charged) or in inverted voltage gradient mode.

Under certain environmental conditions, the satellite is charged negatively to several kilovolts and the resulting discharges are discharges of metallic origin when the structure discharges. In a laboratory, the representativity of such discharges is obtained by biasing the structure of the samples between $-3\,500\text{ V}$ and $-5\,000\text{ V}$. It is important that the complete measurement and current injection device are also referenced to this voltage. During the measurements, all the devices are thus strongly negatively biased.

E.2.5.2. The flash-over current simulation

The flashover current starts during the blow-off. This current is collected on the cathode at the discharge site.

To simulate this phenomenon correctly, a special power supply ([flash-over simulator](#) in Figure E-10) delivering a triangular current shape is added and connected to this electrode. The current delivered by this source is intended to be sufficient to maintain the conductive plasma between the electrodes at the discharge site during the flashover.

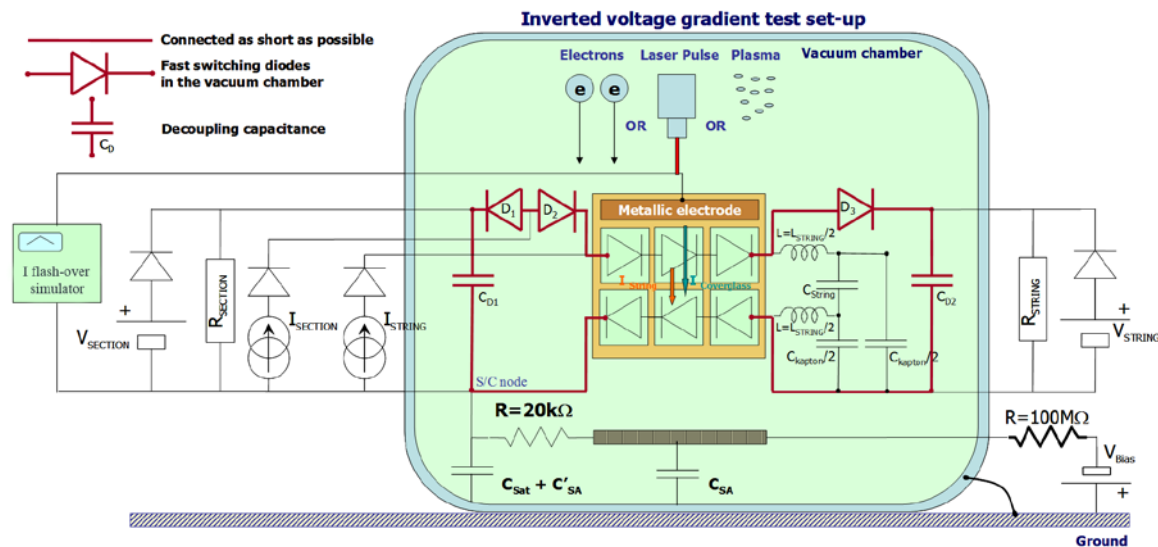

Figure E-10: Setup simulating the satellite including flashover current

E.2.5.3. What is simulated and what is not, discrepancy with the real case

This test allows one to evaluate if the Solar Array is able to support without damage the self powered secondary arc in real space conditions. It reproduces as exactly as possible the real current shape which occurs during this phenomenon.

The current is fully representative of both what happens at the discharge site and the inrush current through the components when the discharge occurs.

However the direction of the static current through the diodes can be reversed compared with the real case depending where it happens. So if component destruction occurs during this test this [does not necessarily happen](#) in a realistic way. In any case this simulation cannot be considered as an electrical susceptibility test which is done during a dedicated EMC test in air.

E.3 Measurement of conductivity and resistivity

E.3.1 Determination of intrinsic bulk conductivity by direct measurement

This can be performed by sensitive measurement of current through a sample of the dielectric, when a fixed potential of up to 500V is applied. The experimental arrangement for a planar sample is shown in Figure E-11. Note

that a guard electrode is used to eliminate surface conductivity effects. For cables, the use of a coaxial version of the cable, eliminates the need for a guard electrode. See Figure E-12.

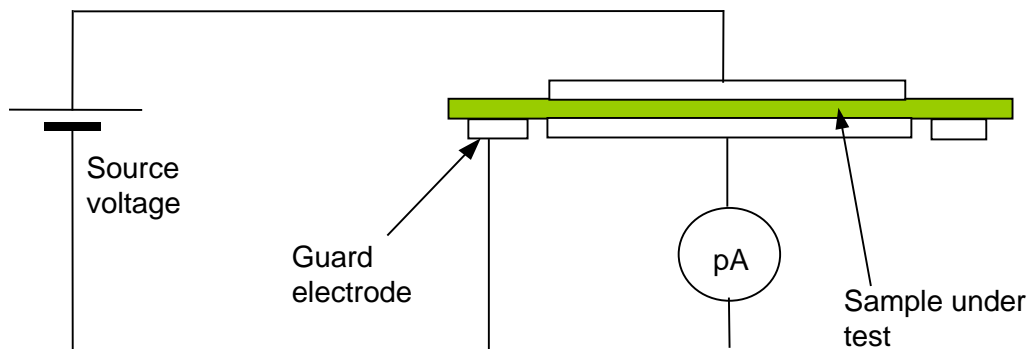

Figure E-11: Basic arrangement of apparatus for measuring dielectric conductivity in planar samples

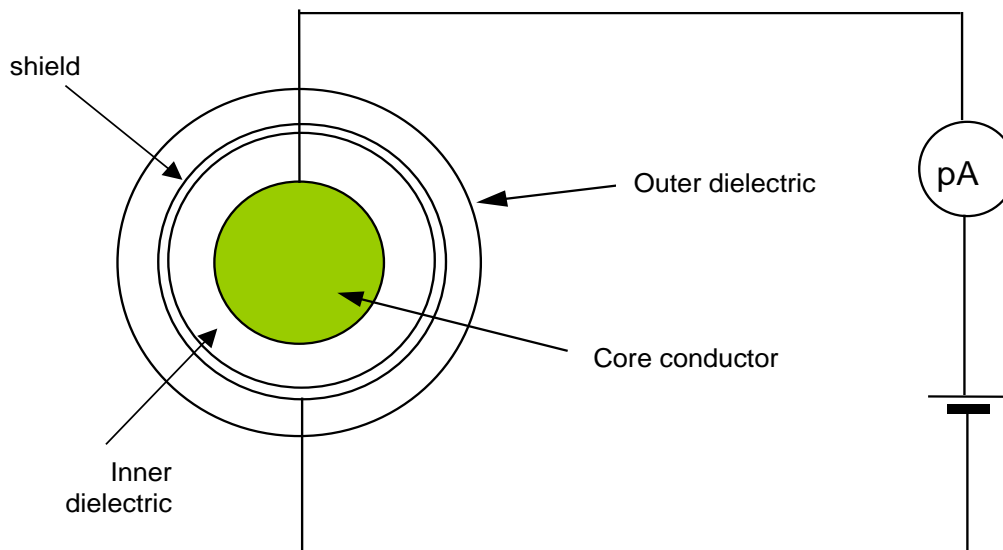

Figure E-12: Arrangement for measuring cable dielectric conductivity and cross-section through co-axial cable

The test is continued until the recorded current has reached an equilibrium value. Note that the industry standard of measuring conductivity 60s after application of the potential produces a result that is contaminated by polarization effects. It is the equilibrium value that is the current due to intrinsic bulk conductivity.

The test reports the conductivity at the lowest operating temperature of the equipment (generally -10°C), although this can be done by carrying out the tests at a pair of somewhat higher temperatures (up to 50°C) and extrapolating down to -10°C .

The test is carried out on a sample of dielectric that is the same as being used in the design, i.e. same parameters, for example colour and thickness.

E.3.2 Determination of radiation-induced conductivity coefficients by direct measurement

The conductivity measurements are carried out on a sample that is subject to irradiation by gamma rays. Figure E-13 shows a suitable experimental arrangement for planar samples.

Because of the need to eliminate conductivity from ionized molecules in the air, the test are carried out in vacuum for planar samples.

The dose rate covers the range 1 to 100 rads s⁻¹.

Where a coaxial cable is being used for cable samples, the sealed nature of the cable core means that measurements can be carried out in air.

It is important to ensure that the atomic number of the electrodes is similar to that of the material under test, otherwise Compton scattering of electrons from the electrodes can lead to erroneous results.

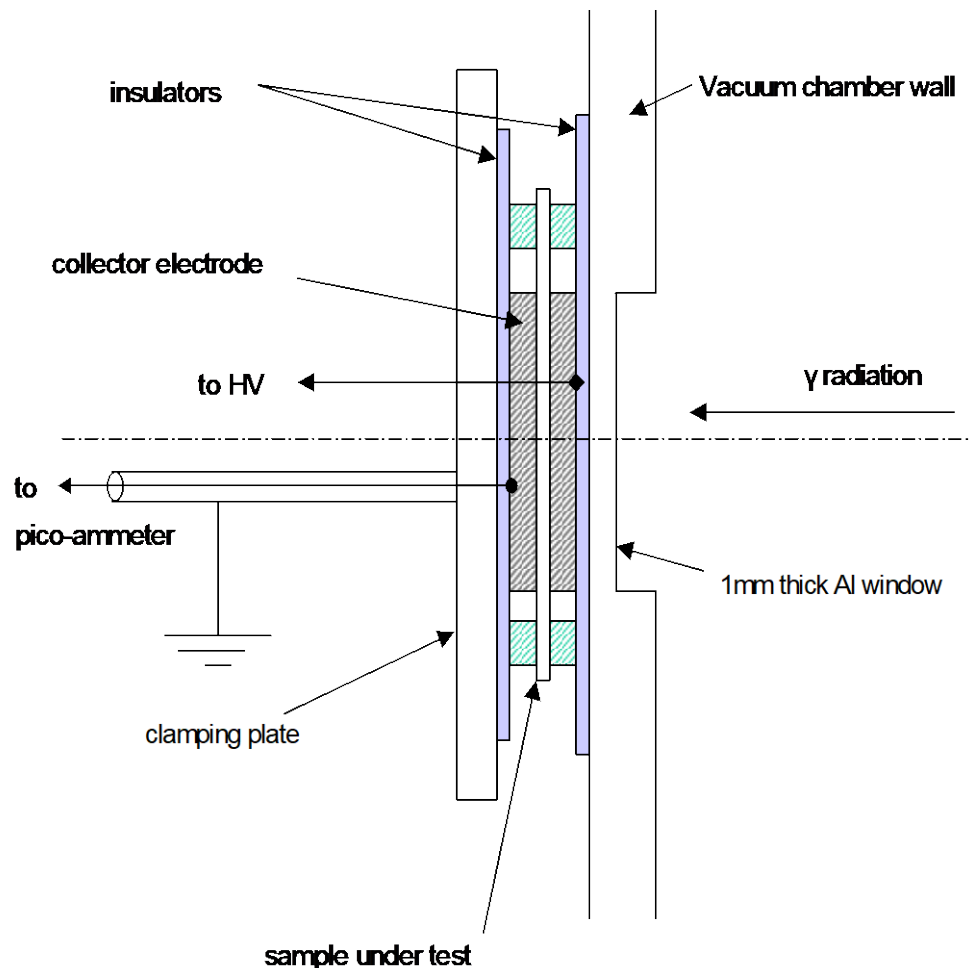

Figure E-13: Arrangement for carrying out conductivity tests on planar samples under irradiation

E.3.3 Determination of conductivity and radiation-induced conductivity by electron irradiation

As an alternative to the conductivity measurements described above, the conductivity and radiation-induced conductivity can be established by a series of tests in which electrons irradiate the sample, under vacuum and the surface potential is measured.

From these tests, the conductivity and radiation-induced conductivity coefficients can be obtained by fitting to an internal charging conductivity model, such as DICTAT.

E.3.4 The ASTM method for measurement of surface resistivity and its adaptation for space used materials

A standard ASTM (D257-07) method exists for surface resistivity, although it is not adapted to materials in space, under vacuum and particles. It is known that insulators resistivity is enhanced by the space radiation and we know that the charging process occurs under electron bombardment. In other words, measuring surface resistivity is probably worthwhile if space environment effects are reproduced. Consequently, we envision adapting the ASTM method under an electron beam. The standard ASTM method requires the measurement of a current I under the application of a voltage V across a gap. Instead, the voltage V under the application of a current I delivered by an electron gun is measured. See [29]. The electron beam charges up the central floating electrode while the external electrode is kept grounded. In the same time the electron beam charges the central electrode and irradiates the gap where the surface resistivity is to be measured, between the central and the external electrode. Another deviation from the standard ASTM method is that samples have no backside conductive electrode. This guarantees that the voltage V stabilizes due to only the surface current.

The surface resistivity R_{\square} is computed from the knowledge of I_t (total current on inner electrode); $D1$, $D2$ (see Figure E-14) ; and the measured voltage V_m .

$$R_{\square} = \pi (D2 + D1) V_m / (D2 - D1) I_t$$

The external metal coating is grounded and the internal metal coating is charged by the electrons to a measured level V_m , depending on the surface resistivity and sample geometry. With a total current $I_t = S \cdot I_i$ (for area S) there is a relationship between the surface resistivity and the measured voltage V_m , e.g for $D2=2,1$ cm and $D1=2$ cm, $R_{\square} = 128,8 V_m / I_t$.

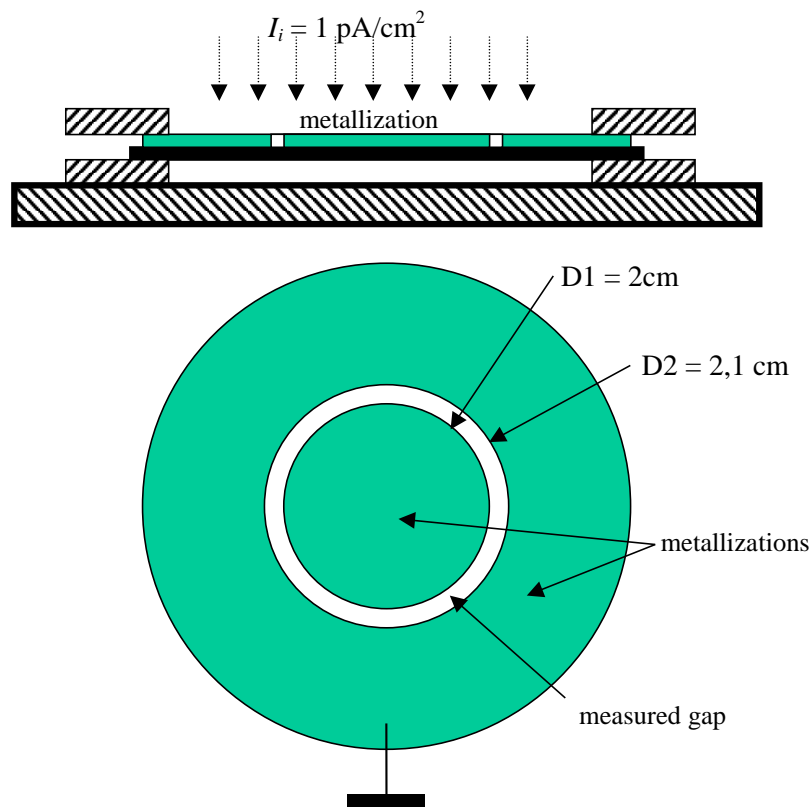

An inner coated disc $\Phi 1 = 2 \text{ cm}$, and a concentric external coating define an angular gap of 0,5 mm.

Figure E-14: Basic experimental set up for surface conductivity

References

- [1] Langmuir, I and K.B. Blodgett, Currents limited by space charge between concentric spheres, *Phys. Rev*, 23,49, 1924.
- [2] Thiébault, B., A. Hilgers, E. Sasot, H. Laakso, P. Escoubet, V. Génot, and J. Forest, Potential barrier in the electrostatic sheath around a magnetospheric spacecraft, *J. Geophys. Res.*, Vol. 109, No. A12, 2004.
- [3] SPINE network, <http://www.spis.org/>.
- [4] Whipple, E.C., Potentials of surfaces in space, *Rep. Prog. Phys.*, 44, 1197-1250, 1981.
- [5] Garrett, H.B., The charging of spacecraft surfaces, *Rev. Geophys. Space Phys.*, 19, 577-616, 1981.
- [6] Katz, I., Parks, D. E., Mandell, M. J., Harvey J. M., Brownell Jr. D. H., Wang S. S., Rotenberg M., A three dimensional dynamic study of electrostatic charging of materials, NASA CR-135256 sss-r-77-3367, NASA LRC, 1977.
- [7] C.K.Purvis,H.B.Garrett, A.C.Whittlesey and N.J.Stevens , 'Design Guidelines for Assessing and Controlling Spacecraft Charging Effects', NASA TP2361, 1984
- [8] Grard R.J.L., K.Knott and A.Pedersen, 'The influence of photoelectrons and secondary electron emission on electric field measurements in the magnetosphere and solar wind', p.163, 'Photon and Particle Interactions with Surface in Space', Ed. R.J.L.Gard, D.Riedel Publishing Co., 1973.
- [9] Escoubet C. P., Pedersen A., Schmidt R. and Lindqvist P.A., Density in the magnetosphere inferred from ISEE 1 spacecraft potential, *J. Geophys. Res.*, 102, 17595-17609, 1997.
- [10] Martin A.R., D.J.Rodgers, R.L.Kessel, A.D.Johnstone, A.J.Coates, B.N.Maehlum, K.Svenes and M.Friedrich, 'Spacecraft/Plasma Interactions and Electromagnetic Effects in LEO and Polar Orbits', Final report on ESA contract no., 7989/88/NL/PB(SC), Culham Report no. CLM/RR/E5/7, 1990
- [11] <http://www.svec.uh.edu/wsfp.html>
- [12] Alpert Y.L., A.V.Gurevich and L.P.Pitaevskii, 'Space Physics with Artificial Satellites', Consult Bureau, New York, 1965
- [13] Iess L., Space Tethers: an Overview, Proceedings 7th Spacecraft Charging Technology Conference, ESA-ESTEC, Noordwijk, The Netherlands, 23-27 April 2001, ESA SP-476, p.61, 2001

- [14] Cooke, D., Wake effects in spacecraft charging, in Cours de technologie spatiale, Cepadues Ed., CNES, Toulouse, France, 1996, pp 271-287.
- [15] Bassner, H., Berg, H.P., Fetzer, K., and Müller, G., "Ion Propulsion Package IPP for N/S-Stationkeeping of the ARTEMIS Satellite", International Electric Propulsion Conference, IEPC-91-055, 1991.
- [16] Tajmar, M., "Electric Propulsion Plasma Simulations and Influence on Spacecraft Charging", Journal of Spacecraft and Rockets, in Press (2002)
- [17] Craven, P. D., Olsen, R.C., Fennell, J., Croley, D., Aggson, T., "Potential modulation on the SCATHA spacecraft", Journal of Spacecraft and Rockets, Vol. 24, 1987, pp. 150-157
- [18] Olsen, R.C., "Modification of Spacecraft Potentials by Plasma Emission", Journal of Spacecraft, Vol. 18, No. 5, 1981, pp. 462-469.
- [19] Avoiding Problems caused by Spacecraft On-orbit Internal Charging Effects, NASA Technical Handbook, NASA-HDBK-4002, February 17, 1999
- [20] D.J.Rodgers, K.A.Ryden, P.M.Latham, L.Lévy and G.Panabière, 1999 Engineering Tools for Internal Charging, Final Report on ESA contract no. 12115/96/NL/JG(SC), DERA/CIS(CIS2)/7/36/2/4/FINAL, 1999
(www.estec.esa.nl/wmwww/WMA/reports/idc/final_report.pdf)
- [21] Chadwick, J., Radioactivity and radioactive substances, Pitman, London, 1921.
- [22] Glendenin and Coryell, Nucleonics, 1, 31, 1948.
- [23] Katz, I. and A.S. Penfold, Rev. Mod. Phys., 24, 28, 1952.
- [24] Weber, K.H., Nucl. Inst. Meth., 25, pp. 261, 1964.
- [25] Trenkel, C., Comparison of GEANT 3.15 and ITS 3.0 Radiation Transport Codes, ESA working paper, EWP 1747, 1993.
- [26] Halbleib J.A. et al. ITS version 3.0: The Integrated TIGER Series of Coupled Electron/Photon Monte Carlo Transport Codes, Sandia National Laboratories, Mar 1992
- [27] Brun R. et al. GEANT User's Guide 1993
- [28] 'Methods of test for volume resistivity and surface resistivity of solid electrical insulating materials', IEC 93, Second Edition 1980.
- [29] 'Standard test methods for DC resistance or conductance of insulating materials', ASTM D 257-07 (2007).
- [30] D.J.Rodgers, K.A.Ryden, P.M.Latham, G.L.Wrenn, L.Lévy, and B.Dirassen, Engineering Tools for Internal Charging, Final Report on ESA contract no. 12115/96/NL/JG(SC) CCN no.2, DERA/CIS/CIS2/CR000277, 2000
- [31] Adamec, V. and J. Calderwood, J Phys. D: Appl. Phys., 8, 551-560, 1975.
- [32] Onsager, L., J Chem. Phys., 2, 599-615, 1934..
- [33] Fowler, J.F., Proc. Royal Soc., London, A 236, 464, 1956.

- [34] Weaver L., J.Shultis, and R.Faw, Analytic solutions for radiation induced conductivity in insulators, *J. Appl. Phys.*, 48, No. 7, 1977.
- [35] Touboul P., B.Foulon and E.Willemenot, Electrostatic space accelerometers for present and future missions, *Acta Astronautica*, 45, no.10, pp.605-617, 1999
- [36] Knudson A.R., S.Buchner, P.McDonald, W.J.Stapor, S.Lewis and Y.Zhao, The effects of radiation on MEMS accelerometers, *IEEE Trans. Nucl. Sci*, 43, no.6, pp.3122-3126, 1996
- [37] LISA Pre-Phase A Report, Second Edition, July 1998, <http://lisa.jpl.nasa.gov/documents/ppa2-09.pdf>
- [38] Denis Payan , François Sévérin, Jean-Pierre Catani, (CNES), Jean-François Roussel, René Reulet, Daniel Sarrail, (Onera/DESP) : “Electrostatic Discharges on Solar Arrays. Physical Model of Inverted Potential Gradient Electrostatic Discharge.” 7th SCTC, 23-27 April 2001, Noordwijk, The Netherlands.
- [39] EMAGS 2 – Final Report »ESA contract, ASTRIUM Report reference EUR3.RP.07724.DP.T.ASTR, Ludovic Gaillot (& Léon Lévy & Daniel Sarrail), 06 january 2005.
- [40] Wrenn G. L. and A. J. Sims `Surface Potentials of Spacecraft Materials', Proc. ESA Workshop on Space Environment Analysis, p. 4.15, ESA WPP-23, 1990
- [41] Katz I., J.J.Cassidy, M.J.Mandell, G.W.Schnuelle, P.G.Steen and J.C.Roche, `The Capabilities of the NASA Charging Analyzer Program', in `Spacecraft Charging Technology -1978', Ed. R.C.Finke and C.P.Pike, NASA CP-2071/AFGL TR-79-0082, ADA045459, p.101, 1979
- [42] Lilley J.R., Cooke D.L, G.A.Jongeward and I.Katz `POLAR User's Manual', AFGL-TR-85-0246.
- [43] Vasilyev Ju.V, V.V.Danilov, V.V.Danilov, V.M.Dvoryashin, A.M.Kramrenko and V.S.Sokolov, `Computer Modeling of Spacecraft Charging Using ECO-M', Proc.International Conference of Problems of Spacecraft/Environment Interactions, June 15-19, 1992 Novosibirsk, Russia, p.187, 1993.
- [44] Soubeyran, A.; Drolshagen, G.; Levy, L.; Matucci, A.; Kensek, R.P.; Betz, G.; Fehring; Rudenhauer, F.G., "Deep Dielectric Charging Simulation New Guidelines", in IEEE proceedings of Radiation Effects Data Workshop, IEEE, 21 July 1993, pp.93 – 98, 1993.
- [45] D.J.Rodgers, K.A.Ryden, R. Bielby, K., A. Hunter, S. N. Clucas, P. A. Morris, G.L.Wrenn, and L.Lévy, Internal Charging Anomaly Study and Tool Development, Final Report of ESA contract no. 16265/02/NL/FM, QINETIQ/KI/SPACE/TR050693, 2005.
- [46] Krupnikov K.K, V.N.Mileev, L.S.Novikov and G.V.Babkin, `Mathematical Modelling of High Altitude Spacecraft Charging', Proc.International Conference of Problems of Spacecraft/Environment Interactions, June 15-19, 1992 Novosibirsk, Russia, p.167, 1993.

-
- [47] Jordan, T.M , ‘Space system analysis using the NOVICE code system’, pp.312-316, Proc. Radiation and its Effects on Devices and Systems(RADECS), 1991.
- [48] Geant4 Collaboration, ‘Geant4—a simulation toolkit’, pp.250-303, Nuclear Instruments and Methods, Vol. 506, Issue 3 , 1 July 2003,
- [49] V. Inguibert et al., “Measurements of the flashover expansion on a real-solar panel—Preliminary results of EMAGS3 project,” IEEE Trans. Plasma Sci., vol. 41, no. 12, pp. 3370–3379, Dec. 2013.
- [50] A. Gerhard et al., “Analysis of solar array performance degradation during simulated flashover discharge experiments on a full panel and using a simulator circuit,” IEEE Trans. Plasma Sci., vol. 43, no. 11, pp. 3933–3938, Nov. 2015
- [51] Fu-Chien Chiu, “A Review on Conduction Mechanisms in Dielectric Films,” Advances in Materials Science and Engineering, vol. 2014, Article ID 578168, 18 pages, 2014.<https://doi.org/10.1155/2014/578168>.

Bibliography

ECSS-S-ST-00	ECSS System – Description, implementation and general requirements
ECSS-E-ST-10	Space engineering – System engineering general requirements
ECSS-E-ST-10-02	Space engineering – Verification
ECSS-E-ST-10-03	Space engineering – Testing
ECSS-E-ST-10-04	Space engineering - Space environment
ECSS-E-ST-10-12	Space engineering – Method for the calculation radiation received and its effects, and a policy for design margins
ECSS-E-ST-20-01	Space engineering – Multipaction design and test
ECSS-E-ST-20	Space engineering – Electrical and electronic
ECSS-E-ST-20-07	Space engineering – Electromagnetic compatibility
ECSS-E-ST-20-08	Space engineering – Photovoltaic assemblies and components
ECSS-E-HB-20-06	Space engineering – Assessment of space worst case charging handbook
ECSS-E-ST-35	Space engineering – Propulsion general requirements
ECSS-E-ST-35-01	Space engineering – Liquid and electric propulsion for spacecraft
ECSS-Q-ST-70-71	Space product assurance – Data for selection of space materials and processes
ISO 14302:2002	Space systems – Electromagnetic compatibility requirements