

Space Engineering

Verification

Published by: ESA Publications Division
ESTEC, P.O. Box 299,
2200AG Noordwijk,
The Netherlands

ISSN: 1028-396X

Price: Dfl 50

Printed in the Netherlands

Copyright 1998 © by the European Space Agency for the members of ECSS

Foreword

This standard is one of the series of ECSS Standards intended to be applied together for the management, engineering and product assurance in space projects and applications. ECSS is a cooperative effort of the European Space Agency, National Space Agencies and European industry associations for the purpose of developing and maintaining common standards.

Requirements in this standard are defined in terms of what shall be accomplished, rather than in terms of how to organize and perform the necessary work.

This allows existing organizational structures and methods to be applied where they are effective, and for the structures and methods to evolve as necessary without rewriting the standards.

The formulation of this standard takes into account the existing ISO 9000 family of documents.

This standard has been prepared by the ECSS Working Group E-10-02, reviewed by the ECSS Technical Panel and approved by the ECSS Steering Board.

(This page is intentionally left blank)

Contents List

| | |
|--|-----------|
| Foreword | 3 |
| 1 Scope | 11 |
| 1.1 General | 11 |
| 1.2 Relationship with other standards | 12 |
| 2 Normative references | 13 |
| 3 Definitions and abbreviations | 15 |
| 3.1 Definitions | 15 |
| 3.2 Abbreviations | 17 |
| 4 Verification process | 19 |
| 4.1 Verification objectives | 19 |
| 4.2 Verification process logic | 19 |
| 4.3 Verification methods | 20 |
| 4.4 Verification levels | 21 |
| 4.5 Verification stages | 22 |
| 5 Verification strategy | 25 |
| 5.1 Requirements classification | 25 |

| | | |
|-----|---|----|
| 5.2 | Selection of methods, levels and stages of verification | 27 |
| 5.3 | Selection of models | 29 |
| 5.4 | Verification by test | 29 |
| 5.5 | Verification by analysis | 30 |
| 5.6 | Verification by Review-of-design | 31 |
| 5.7 | Verification by inspection | 32 |
| 5.8 | Re-flight verification | 32 |

6 Verification implementation **35**

| | | |
|-----|--|----|
| 6.1 | Verification responsibilities | 35 |
| 6.2 | Verification planning | 36 |
| 6.3 | Verification tools | 37 |
| 6.4 | Verification execution and control | 39 |
| 6.5 | Verification documentation | 41 |

Annex A (normative) Verification documents **47**

Annex B (informative) Verification guidelines **49**

| | | |
|-----|--|----|
| B.1 | Model and model philosophy definition guidelines | 49 |
| B.2 | Specific tailoring guidelines | 62 |
| B.3 | Re-verification review guidelines for re-flight | 64 |
| B.4 | Verification activities guidelines | 66 |
| B.5 | Typical verification team responsibility | 70 |

Annex C (normative) Verification matrix - Document Requirements

Definition (DRD) **73**

| | | |
|-----|--|----|
| C.1 | Introduction | 73 |
| C.2 | Scope and applicability | 73 |
| C.3 | References | 73 |
| C.4 | Definitions, abbreviations and symbols | 74 |
| C.5 | Description and purpose | 74 |
| C.6 | Application and interrelationship | 74 |
| C.7 | Verification matrix preliminary elements | 75 |
| C.8 | Content | 75 |

Annex D (normative) Assembly, Integration and Verification (AIV) plan -

Document Requirements Definition (DRD) **79**

| | | |
|-----|--|----|
| D.1 | Introduction | 79 |
| D.2 | Scope and applicability | 79 |
| D.3 | References | 79 |
| D.4 | Definitions, abbreviations and symbols | 80 |
| D.5 | Description and purpose | 81 |
| D.6 | Application and interrelationship | 81 |
| D.7 | AIV plan preliminary elements | 81 |
| D.8 | Content | 82 |

Annex E (normative) Verification Control Document (VCD) - Document

Requirements Definition (DRD)..... 93

| | | |
|-----|--|----|
| E.1 | Introduction | 93 |
| E.2 | Scope and applicability | 93 |
| E.3 | References | 93 |
| E.4 | Definitions, abbreviations and symbols | 94 |
| E.5 | Description and purpose | 94 |
| E.6 | Application and Interrelationship | 94 |
| E.7 | VCD preliminary elements | 95 |
| E.8 | Content | 95 |

Annex F (normative) Test specification - Document Requirements

Definition (DRD) 101

| | | |
|-----|---|-----|
| F.1 | Introduction | 101 |
| F.2 | Scope and applicability | 101 |
| F.3 | References | 101 |
| F.4 | Definitions, abbreviations and symbols | 102 |
| F.5 | Description and purpose | 102 |
| F.6 | Application and interrelationship | 102 |
| F.7 | Test specification preliminary elements | 103 |
| F.8 | Content | 103 |

Annex G (normative) Test procedure - Document Requirements

Definition (DRD) 107

| | | |
|-----|--|-----|
| G.1 | Introduction | 107 |
| G.2 | Scope and applicability | 107 |
| G.3 | References | 107 |
| G.4 | Definitions, abbreviations and symbols | 108 |
| G.5 | Description and purpose | 108 |

| | | |
|-----|---|-----|
| G.6 | Application and interrelationship | 108 |
| G.7 | Test procedure preliminary elements | 108 |
| G.8 | Content | 109 |

Annex H (normative) Test Report - Document Requirements

| | | |
|-----|--|------------|
| | Definition (DRD) | 113 |
| H.1 | Introduction | 113 |
| H.2 | Scope and applicability | 113 |
| H.3 | References | 113 |
| H.4 | Definitions, abbreviations and symbols | 114 |
| H.5 | Description and purpose | 114 |
| H.6 | Application and interrelationship | 114 |
| H.7 | Test report preliminary elements | 115 |
| H.8 | Content | 115 |

Annex I (normative) Analysis report - Document Requirements

| | | |
|-----|--|------------|
| | Definition (DRD) | 119 |
| I.1 | Introduction | 119 |
| I.2 | Scope and applicability | 119 |
| I.3 | References | 119 |
| I.4 | Definitions, abbreviations and symbols | 120 |
| I.5 | Description and purpose | 120 |
| I.6 | Application and interrelationship | 120 |
| I.7 | Analysis report preliminary elements | 121 |
| I.8 | Content | 121 |

Annex J (normative) Review-of-Design report - Document

| | | |
|-----|--|------------|
| | Requirements Definition (DRD)..... | 125 |
| J.1 | Introduction | 125 |
| J.2 | Scope and applicability | 125 |
| J.3 | References | 125 |
| J.4 | Definitions, abbreviations and symbols | 126 |
| J.5 | Description and purpose | 126 |
| J.6 | Application and interrelationship | 126 |
| J.7 | ROD report preliminary elements | 127 |
| J.8 | Content | 127 |

Annex K (normative) Inspection report - Document Requirements

| | | |
|-----|--|------------|
| | Definition (DRD) | 131 |
| K.1 | Introduction | 131 |
| K.2 | Scope and applicability | 131 |
| K.3 | References | 131 |
| K.4 | Definitions, abbreviations and symbols | 132 |
| K.5 | Description and purpose | 132 |
| K.6 | Application and interrelationship | 132 |
| K.7 | Inspection report preliminary elements | 133 |
| K.8 | Content | 133 |

Annex L (normative) Verification report - Document Requirements

| | | |
|-----|--|------------|
| | Definition (DRD) | 137 |
| L.1 | Introduction | 137 |
| L.2 | Scope and applicability | 137 |
| L.3 | References | 137 |
| L.4 | Definitions, abbreviations and symbols | 138 |
| L.5 | Description and purpose | 138 |
| L.6 | Application and interrelationship | 138 |
| L.7 | Verification report preliminary elements | 139 |
| L.8 | Content | 139 |

Tables

| | | |
|------------|--|-----|
| Table 1: | Typical requirement categorization | 26 |
| Table A-1: | ECSS-E-10-02 DRD Index | 47 |
| Table B-1: | Model definition | 53 |
| Table C-1: | Example of filled format table | 76 |
| Table D-1: | Example of hardware matrix format | 85 |
| Table D-2: | Example of filled hardware matrix format | 86 |
| Table D-3: | Example of preliminary verification matrix format | 87 |
| Table D-4: | Example of filled preliminary verification matrix format | 87 |
| Table D-5: | Example of verification strategy format | 88 |
| Table D-6: | Example of test matrix format | 90 |
| Table D-7: | Example of filled test matrix format | 90 |
| Table D-8: | Example of AIV planning format | 91 |
| Table D-9: | Example of filled AIV planning format | 91 |
| Table E-1: | Example of filled format table | 98 |
| Table G-1: | Example of step by step procedure format | 111 |

Table G-2: Example of filled format 111

Figures

Figure 1: Typical verification process phasing with the project life cycle 38

Figure 2: Verification documentation 42

Figure B-1: Unmanned Project Model philosophy 55

Figure B-2: Manned Project Model philosophy 56

Figure B-3: Protoflight Model philosophy 58

Figure B-4: Hybrid Model philosophy 60

Figure B-5: Typical hardware matrix 61

Figure B-6: Verification activities flow (Phases A and B) 68

Figure B-7: Verification activities flow (Phases C/D and E/F) 69

Figure C-1: Example of verification entries format 77

Figure D-1: Example of model philosophy format 84

Figure D-2: Example of filled model philosophy format 85

Figure D-3: Example of filled verification strategy format 90

Figure E-1: Example of VCD sheet format 98

Figure H-1: Example of test report sheet 117

Figure H-2: Example of filled format 118

Figure I-1: Example of an analysis report sheet format 123

Figure I-2: Example of filled format 124

Figure J-1: Example of a Review-of-Design report sheet format 129

Figure J-2: Example of filled format 130

Figure K-1: Example of an inspection report sheet format 135

Figure K-2: Example of filled format 136

Figure L-1: Example of a verification report sheet format 141

Figure L-2: Example of filled format 142

Scope

1.1 General

This standard establishes the requirements for the verification of a space system product.

It specifies the fundamental concepts of the verification process, the criteria for defining the verification strategy and the rules for the implementation of the verification programme.

It includes also in annex A and B the description of the required documentation (i.e. DRDs) and some guidelines on specific aspects of the verification process such as the Model Philosophy definition.

This standard is intended to apply to different products at different levels (i.e. from a single equipment to the overall system). It is applicable to both the customer and the supplier of the product during all project phases.

The application of these requirements to a particular project is intended to result in an effective product verification and consequently to a high confidence in achieving successful product operations for the intended use.

The requirements of this standard may be tailored for each specific space application, in line with the general ECSS tailoring guidelines (ref. ECSS-M-00-02) taking into account also specific guidelines described in annex B.2.

In preparing this standard the following goals have been considered to facilitate its application, effective use and tailoring:

- definition of an envelope of the sets of minimum verification requirements applicable to the different products, so that tailoring is a selection (in reduction) process;
- clear identification of mandatory requirements, tailorable requirements and recommendations by means of the appropriate use of “shall”, “should” and “may” respectively;
- text defining requirements shall be self-standing to the greatest possible extent, to allow direct tailoring.

1.2 Relationship with other standards

Requirements for verification called in other ECSS Standards shall be implemented in accordance with this standard.

The relationships of this standard with other ECSS Standards are as follows:

| | |
|--------------|---|
| ECSS-E-10 | Space engineering - System engineering: for the high level requirements for verification |
| ECSS-E-10-03 | Space engineering - Testing (to be published): for the standard requirements for test selection and performance |
| ECSS-E-20 | Space engineering - Electrical and electronic (to be published): for the specific verification requirements applicable to the discipline or to the relevant lower level product |
| ECSS-E-30 | Space engineering - Mechanical (to be published): for the specific verification requirements applicable to the discipline or to the relevant lower level product |
| ECSS-E-40 | Space engineering - Software (to be published): for the specific verification requirements applicable to the discipline or to the relevant lower level product |
| ECSS-E-50 | Space engineering - Communications (to be published): for the specific verification requirements applicable to the discipline or to the relevant lower level product |
| ECSS-E-70 | Space engineering - Ground systems and operation (to be published): for the specific verification requirements applicable to the discipline or to the relevant lower level product |
| ECSS-M-00 | Space project management - Policy and principles: for the general requirements for risk management |
| ECSS-M-00-02 | Space project management - Selection and tailoring process (to be published): for the general guidelines for tailoring ECSS Standards |
| ECSS-M-30 | Space project management - Project phasing and planning: for project phases and reviews, to which the verification process is strictly related |
| ECSS-M-40 | Space project management - Configuration management: for the requirements for configuration management, in particular with regard to change control |
| ECSS-Q-20 | Space product assurance - Quality assurance: for the quality assurance role in verification and, in particular, for the requirements related to inspection, testing, and acceptance |
| ECSS-Q-20-09 | Space product assurance - Nonconformance control system: for the requirements for non-conformance processing and associated responsibilities |
| ECSS-Q-40 | Space product assurance - Safety: for those verifications which form part of hazard close-out |
| ECSS-Q-60 | Space product assurance - EEE components: for the general requirements for the evaluation, approval and procurement of EEE components |
| ECSS-Q-70 | Space product assurance - Materials, mechanical parts and processes: for the general requirements for the evaluation, approval and procurement of materials and mechanical parts |

Normative references

This ECSS Standard incorporates, by dated or undated reference, provisions from other publications. These normative references are cited at the appropriate places in the text and publications are listed hereafter. For dated references, subsequent amendments to or revisions of any of these apply to this ECSS Standard only when incorporated in it by amendment or revision. For undated references the latest edition of the publication referred to applies.

| | |
|--------------|--|
| ECSS-P-001 | Glossary of terms |
| ECSS-M-00 | Space project management - Policy and principles |
| ECSS-M-00-02 | Space project management - Selection and tailoring process (to be published) |
| ECSS-M-30 | Space project management - Project phasing and planning |
| ECSS-Q-20 | Space product assurance - Quality assurance |
| ECSS-Q-20-09 | Space product assurance - Nonconformance control system |
| ECSS-Q-40 | Space product assurance - Safety |
| ECSS-Q-60 | Space product assurance - EEE components |
| ECSS-Q-70 | Space product assurance - Materials, mechanical parts and processes |
| ECSS-E-10 | Space engineering - System engineering |
| ECSS-E-10-03 | Space engineering - Testing (to be published) |

(This page is intentionally left blank)

Definitions and abbreviations

3.1 Definitions

For the purposes of this standard, the definitions given in ECSS-P-001 apply. In particular, it should be noted that the following terms have a specific definition for use in ECSS Standards.

Acceptance
Analysis
Critical Items
Development
Element
Environment
Equipment
Inspection
Model
Process
Product
Project
Qualification (process)
Repair
Requirement
Review
Safety
Subsystem
System
Supplier
Tailoring
Test
Traceability
Validation

Verification

Waiver

Workmanship

The following terms and definitions are specific to this standard in the sense that they are complementary or additional with respect to those contained in the ECSS-P-001:

3.1.1 Acceptance stage

A verification stage with the objective of demonstrating that the product is free of workmanship defects and integration errors and ready for its intended use.

3.1.2 Analysis

A verification method which entails performing a theoretical or empirical evaluation by accepted analytical techniques. The selected techniques may typically include systematics, statistics, qualitative design analysis, modelling and computer simulation (see also ECSS-P-001A Rev.1 3.5).

3.1.3 Assembly

The process of mechanical mating hardware to obtain a low level configuration after the manufacturing process (see also ECSS-P-001A Rev.1 3.9).

3.1.4 In-orbit stage

The verification stage valid for projects whose characteristics (e.g. mission, in-orbit operations) require in-orbit verification.

3.1.5 Inspection

A verification method that determines conformance to requirements for constructional features, document and drawing conformance, workmanship and physical conditions without the use of special laboratory equipment, procedures or services (see also ECSS-P-001A Rev.1 3.73).

3.1.6 Integration

The process of physically and functionally combining lower level products (hardware and/or software) to obtain a particular functional configuration.

3.1.7 Model philosophy

The definition of the optimum number and characteristics of physical models required to achieve a high confidence in the product verification with the shortest planning and a suitable weighing of costs and risks.

3.1.8 Post-landing stage

The verification stage valid for projects whose characteristics require post-landing verification (e.g. multimission projects).

3.1.9 Pre-launch stage

The verification stage with the objective to verify that the flight article is properly configured for launch and, to the extent practical, it is capable to function as planned for launch.

3.1.10 Qualification stage

The verification stage with the objective to demonstrate that the design meets the applicable requirements including proper margins.

3.1.11 Review-of-design

A verification method using validation of previous records or evidence of validated design documents, when approved design reports, technical descriptions and engineering drawings unambiguously show that the requirement is met.

3.1.12 Test

A verification method wherein requirements are verified by measurement of product performance and functions under various simulated environments (see also ECSS-P-001A Rev.1 3.147).

3.1.13 Verification Level

The product architectural level at which the relevant verification is performed.

3.2 Abbreviations

The following abbreviations are defined and used within this standard.

| Abbreviation | Meaning |
|---------------------|--|
| AIV | Assembly, Integration and Verification |
| AOCS | Attitude and Orbit Control System |
| AR | Acceptance Review |
| BB | Bread Board |
| CDR | Critical Design Review |
| CR | Commissioning Review |
| DM | Development Model |
| DRD | Document Requirements Definition |
| ECLS | Environmental Control and Life System |
| ECSS | European Cooperation for Space Standardization |
| EEE | Electronic Electrical and Electromechanical |
| EIDP | End Item Data Package |
| EM | Engineering Model |
| EMC | Electromagnetic Compatibility |
| EOL | End of Life |
| EQM | Engineering Qualification Model |
| ESD | Electrostatic Discharge |
| EVA | Extra Vehicular Activities |
| FM | Flight Model |
| FMECA | Failure Mode Effects and Criticality Analysis |
| FS | Flight Spare |
| GPS | Global Positioning System |
| GSE | Ground Support Equipment |
| HFE | Human Factors Engineering |
| H/W | Hardware |
| I/F | Interface |
| ICD | Interface Control Document |
| IM | Integration Model |
| ISO | International Standard Organization |
| IVA | Intra Vehicular Activities |

| | |
|-----------------|---------------------------------|
| LL | Lower Level |
| LRR | Launch Readiness Review |
| MRB | Material Review Board |
| MU | Mock-up |
| NCR | Nonconformance Report |
| OBDH | On-board Data Handling |
| OFT | Orbital Flight Test |
| P/L | Payload |
| PDR | Preliminary Design Review |
| PFM | Protoflight Model |
| PRR | Preliminary Requirement Review |
| PTR | Post Test Review |
| QM | Qualification Model |
| QR | Qualification Review |
| RCS | Reaction Control System |
| RF | Radio Frequency |
| RFW | Request for Waiver |
| S/C | Spacecraft |
| SS | Subsystem |
| S/W | Software |
| SM | Structural Model |
| SRR | System Requirements Review |
| STE | Special Test Equipment |
| STM | Structural-Thermal Model |
| SVF | Software Validation Facility |
| TCL | Test Configuration List |
| TM | Thermal Model |
| TRR | Test Readiness Review |
| TT&C | Telemetry, Tracking and Command |
| VCB | Verification Control Board |
| VCD | Verification Control Document |

Verification process

The verification process is that part of the supplier's task which demonstrates conformance to applicable requirements. A satisfactory completion of the verification process is the basis for a contractual acceptance (as defined in ECSS-P-001) of the product by the customer.

4.1 Verification objectives

The verification objectives shall be primarily:

- a. to qualify the design;
- b. to ensure that the product is in agreement with the qualified design, is free from workmanship defects and acceptable for use;
- c. to verify that the space system (including tools, procedures and resources) will be able to fulfil mission requirements;
- d. to confirm product integrity and performance after particular steps of the project life cycle (e.g. pre-launch, in-orbit, post-landing).

4.2 Verification process logic

The verification process activities shall be incrementally performed at different levels and in different stages, applying a coherent bottom-up building-block concept and utilizing a suitable combination of different verification methods.

4.2.1 Verification process flow

The verification process flow shall be basically subdivided in the following steps:

- a. identification and classification of all the requirements to be verified;
- b. selection of verification criteria (e.g. methods/levels/stages) and models against identified requirements;
- c. establishing the planning for the associated verification activities;
- d. customer concurrence;
- e. identification of verification documentation;
- f. performance of verification tasks and verification control;
- g. completion of verification control and evidence of verification close-out;
- h. customer review and final approval.

4.2.2 Verification approach

To reach the verification objectives a verification approach shall be defined in an early phase of the project by analyzing the requirements to be verified taking into account:

- design peculiarities;
- qualification status of candidate solution;
- availability and maturity of verification tools;
- verification and test methodologies;
- programmatic constraints;
- cost and schedule.

4.2.2.1 Verification approach derivation

The basic verification approach shall be derived through an iteration process, based on technical/cost/schedule considerations, which defines the “what”, “how”, “where” and “when” of verification by:

- identifying a consistent set of verifiable project requirements which can be subjected to the verification process;
- selecting methods of verification;
- selecting levels of verification and the associated model philosophy;
- selecting facilities;
- identifying resources required;
- identifying the stages and the events in which the verification is implemented.

4.2.3 Verification close-out

The verification process shall be considered completed when the customer and the supplier mutually agree that, on the basis of proper documented evidence, the identified requirements have been verified and the associated verification objectives fully reached.

4.2.3.1 Verification close-out exceptions

The requirements not fully verified at a certain level shall be identified and resolved with the customer.

4.3 Verification methods

Verification shall be accomplished by one or more of the following verification methods:

- Test
- Analysis
- Review-of-design
- Inspection

4.3.1 Test

When requirements have to be verified by measuring product performance and function under various simulated environments, the method shall be referred to as “Test”.

4.3.1.1 Test principles and procedures

These measurements may require the use of special equipment, instrumentation and simulation techniques. Established principles and procedures shall be used to determine conformance to requirements (see ECSS-E-10-03).

4.3.1.2 Test evaluation

The analysis of data derived from Test shall be considered an integral part of the test.

4.3.1.3 Demonstration

When relevant, Test also includes the demonstration of qualitative operational performance and requirements. The performance, as demonstrated, shall be observed and recorded.

4.3.2 Analysis

When verification is achieved by performing theoretical or empirical evaluation by accepted techniques, the method shall be referred to as "Analysis".

4.3.2.1 Analytical techniques

The analytical techniques shall be selected from amongst systematic, statistical and qualitative design analysis, modelling and computational simulation.

4.3.2.2 Similarity

Verification by similarity is considered part of Analysis. It shall be applied if it can be shown that the article under verification is similar to another article that has already been verified to equivalent or more stringent requirements.

The verification activity consists of the assessment and review of prior test data, hardware configuration and applications.

4.3.3 Review-of-design

When verification is achieved by validation of records or by evidence of validated design documents or when approved design reports, technical descriptions, engineering drawings unambiguously show the requirement is met, the method shall be referred to as "Review-of-design".

4.3.4 Inspection

When verification is achieved by visual determination of physical characteristics (such as construction features, hardware conformance to document drawing or workmanship requirements) the method shall be referred to as "Inspection".

4.4 Verification levels

The requirement verification shall be performed incrementally at different verification levels. The number and type of verification levels depend on the complexity of the project and on its characteristics.

The typical verification levels for a space project (in line with the definition of ECSS-E-00) are:

- Equipment (Example: valves, batteries, individual electronic boxes);
- Subsystem (Example: electrical power, attitude control, structure, thermal control, software);
- Element (Example: launcher, satellite, ground station);
- System (Example: manned infrastructure system).

Below the equipment level there is the parts and materials level. The general requirements for the evaluation, approval and procurement of parts and materials are defined in ECSS-Q-60 and ECSS-Q-70.

Requirements for parts and materials defined in the customer's specification of a product shall be subjected to formal verification.

The identification of the critical verification levels is driven by technical and programmatic considerations (e.g. functional architecture, overhead cost) having

in mind that verification is carried-out against the applicable requirements under the responsibility of the organization upon which the requirements are placed.

4.5 Verification stages

The verification process shall be implemented in subsequent verification stages all along the program life cycle.

The stages depend upon project characteristics and identify a type of verification.

The classical verification stages are:

- Qualification
- Acceptance
- Pre-launch
- In-orbit
- Post-landing

4.5.1 Qualification

In this stage the verification objective shall be to demonstrate that the design meets all applicable requirements and includes proper margins.

4.5.1.1 Qualification article

The articles involved should be fully representative of the design to be qualified. Deviations to this approach may be allowed, based on cost, schedule and risk considerations, by using articles representative in form, fit and function to the extent necessary to meet the qualification objective.

4.5.1.2 Re-qualification

This stage may also include re-qualification in the case that the design is modified after initial qualification has been achieved.

4.5.2 Acceptance

In this stage the verification objective shall be to demonstrate that the item is free of workmanship defects and integration errors and is ready for subsequent operational use.

4.5.2.1 Acceptance article

The involved article shall be manufactured in agreement with the qualified design and shall perform as the qualified product.

4.5.2.2 Re-certification

This stage may also include re-certification in the case that the representative configuration is disassembled (e.g. due to failure or repair actions), or where it has undergone long-term storage.

4.5.3 Pre-launch

The verification objective of the pre-launch stage shall be to verify that the article is properly configured for launch and early operations and, to the extent practicable, it is capable to function as planned for launch.

4.5.4 In-orbit

This stage is valid for projects whose characteristics (e.g. mission or in-orbit operations) require in-orbit verification.

In particular, the in-orbit stage verification objective shall be to supplement ground testing by providing operating conditions which cannot be fully or cost effectively duplicated or simulated on the ground.

At the beginning of this stage a commissioning process is often carried out for particular types of products.

4.5.4.1 In-orbit re-verification

In addition, during in-orbit stage, verification of hardware and software shall be repeated:

- subsequent to modification of previously verified hardware or software;
- following repair or replacement of failed hardware/software;
- when a functional path has not normally been used for a specified period;
- subsequent to in-orbit anomalies or contingencies.

4.5.5 Post-landing

This stage is valid for projects whose characteristics require post-landing verification (e.g. multimission projects).

Post-landing stage verification objective shall be to verify:

- selected functions (at periodical intervals) during storage periods;
- the product status after the mission;
- consequences of in-orbit anomalies.

(This page is intentionally left blank)

Verification strategy

As a basis for the verification process, mandatory technical requirements shall be properly specified for each product (see ECSS-E-10). An adequate verification strategy, in which appropriate methods, levels, stages and models have been selected, shall be prepared by the supplier and submitted to the customer for agreement.

The selection of verification methods, levels, stages and associated models is a compromise between cost, schedule, performance and associated risks (see ECSS-M-00).

5.1 Requirements classification

The requirements applicable to a particular product are contained in Technical Specifications and Interface Control Documents.

The first step of the verification process shall be to identify the requirements to be verified and classify them.

5.1.1 Requirements documentation

The requirements shall be generated and allocated top-down at the different project levels in order to form a tree of Technical Specifications and Interface Control Documents containing consistent performance, design, interface, environmental, operational and support requirements (see ECSS-E-10).

5.1.2 Requirement characteristics

In order to facilitate the verification implementation in terms of planning, execution, control and reporting, the requirement generation and allocation activity shall ensure specific requirements characteristics.

Each requirement shall be:

- **traceable**;
- **unique** and associated to a proper identifier (for instance a document and subclause number);
- **single** and not a combination of several requirements;
- **verifiable** using one or more approved verification methods;

- **unambiguous;**
- **referenced** as necessary to other requirements (with applicable document and subclause identification).

and should be associated with a specific **title**.

In other words a successful verification starts with a satisfactory set of project requirements. Each requirement shall be seen as both the origin and the conclusion of the verification process, and shall be treated as fundamental technical information rather than a constituent of a verbose text.

5.1.3 Requirement criticality

The requirement criticality, in terms of technical and programmatic impacts on the verification implementation, shall be assessed by early involvement of the verification team in the requirement definition process since it drives the verification strategy.

5.1.4 Requirements not to be tracked

Some requirements do not require to be tracked if in practice they are:

- obvious in their execution (example: requirements for test procedure/report);
- redundant with other requirements;
- purely descriptive (example: definitions).

These requirements shall be identified and marked with a proper non-tracking decision.

5.1.5 Requirement categories

The requirements to be verified shall be grouped in categories to facilitate the definition of verification strategy.

The grouping criteria should provide the possibility of identifying a homogeneous verification strategy for the category itself.

The requirement categories depend on the project characteristics and organization. Typical requirement categories are shown in Table 1.

5.1.6 Requirements traceability

The requirement traceability associated with the requirement categorization shall be utilized to assist coherence and completeness of the selected verification strategy.

5.1.7 Verification matrix

The verification strategy shall be reflected in a verification matrix which shows for all requirements the selected verification methods for the different verification levels in the applicable verification stages (see subclause 6.5).

Table 1: Typical requirement categorization

| | |
|---------------------------------|--|
| MECHANICAL | (including structural environment, debris/meteoroid protection, mechanisms) |
| THERMAL | (including thermal environment, thermal control, thermal protection, aerothermal) |
| GUIDANCE NAVIGATION AND CONTROL | (AOCS, rendezvous and docking, piloting) |
| PROPULSION | (including RCS) |
| POWER | (including power generation and distribution) |
| LANDING | (including parachute, retrorockets) |
| COMMUNICATION | (including antennas, RF) |
| DATA MANAGEMENT | (including OBDH, software) |
| ECLS | (including atmosphere control and contamination) |
| MISSION | (including mission definition, life, pointing, stability, orbit, alignment) |
| CONFIGURATION | (including physical properties, interfaces, composition, modularity, accessibility, light tightness) |
| HUMAN FACTORS | (including human factor engineering, man in the loop, IVA, EVA, crew related aspects) |
| EMC | (including ESD, lightning, magnetic cleanliness) |
| QUALITY FACTORS | (including safety, reliability, availability, maintainability) |
| FLIGHT OPERATIONS | (including autonomy, control authority, failure management, operation procedures) |
| GROUND OPERATIONS | (including ground processing, launch site, post landing, control center) |
| SUPPORT | (including GSE, spares, logistics, training) |
| MICROGRAVITY | (including audible noise, human vibration) |

5.2 Selection of methods, levels and stages of verification

The selection of suitable methods, levels and stages of verification shall be dependent upon the project characteristics and the associated requirement categories.

5.2.1 Selection of verification method

After identification of the requirement to be verified the potential verification methods and alternatives in each particular case shall be seen in the context of the overall flow, the testing techniques, and the analytical tools available and assessed for feasibility against the criteria indicated below:

- the method is technically feasible;
- verification facilities are available;
- a sufficient level of confidence can be achieved with reasonable fidelity, accuracy, validity;
- the risks to personnel, flight hardware and facilities are acceptable;
- the impact on schedule is acceptable;

- verification costs are acceptable.

5.2.2 Selection of verification level

The selection of verification levels shall take into account programmatic aspects such as: standardized hardware levels (e.g. service modules), make or buy decisions (e.g. off-the-shelf equipment), reduction of overhead costs (e.g. deletion of subsystem level) and responsibility.

5.2.3 Selection of verification stages

The verification stages shall be selected taking into consideration the project characteristics and associated life cycle. In particular the stages selection shall be seen in close relationship with the adopted model philosophy (see subclause 5.3).

5.2.4 Additional rules for selection

Beside the aspects associated with a specific requirement category, the following additional rules are applicable to the selection of methods, levels and stages of verification:

- a. All safety critical functions shall be verified by test.
- b. Test should be the preferred verification method when it is practical, cost effective and safe; alternative methods may be selected, considering requirement criticality, cost effectiveness and schedule.
- c. Analysis should be used when flight conditions cannot be accurately simulated on the ground and/or when it is not economically feasible to test the entire spectrum of flight conditions. Analysis and test methods are very often complementary.
- d. If several verification methods are possible, each having the same level of confidence on the verification results, the selection shall be oriented to minimize the required effort.
- e. Verification of critical requirements (for instance related to new technologies) should be achieved as early as possible (e.g. at the lowest suitable level) to have early feedback in the programme.
- f. To bypass difficulties of testing (i.e. size of facilities, test representativeness) in presence of complex systems or to minimize expensive system testing a combined approach may be selected, which includes a test campaign at a lower level and analysis at a higher level.
- g. If, in particular, environmental testing at higher level is impracticable or too costly, lower level testing shall be carried out, completed by analysis, to demonstrate conformance to higher level requirements.
- h. When mission characteristics require in-flight verification, the verification shall not rely on in-orbit activities alone; requirements shall be verified with proper methods prior to the first flight in case of a multimission project.
- i. Internal and external interface verification shall be carried-out at the appropriate level of responsibility. In case of testing the use of actual interfaces is preferable to the use of simulators.
- j. A lower level verification should be completed prior to an associated higher level verification.
- k. Duplication of verification activities on different levels should be avoided.
- l. All verifications associated with any stage should be completed prior to the start of the next stage. In particular, qualification should be finished before the start of acceptance.
- m. Verification of software shall include a test in the target hardware environment.

- n. In addition to the combination of the verification activities between the different levels, the verification of complex functional chains (typically operational performances and mechanisms actuation) should foresee integrated end-to-end testing.
- o. All physical or functional requirements for a given product should be verified on that particular product level to the maximum extent feasible and reasonable.

5.3 Selection of models

Models shall be selected defining the optimum number and type of physical models required to achieve a high confidence in the product verification with the shortest schedule and a suitable weigh of costs and risks.

5.3.1 Model philosophy definition

Model philosophy shall be defined by means of an iterative process which combines programmatic constraints, verification strategies and the integration and test programme, taking into account the development status of the candidate design solution (see also ECSS-E-10A Figure 6).

Model philosophy shall be defined early in the project and frozen as soon as possible due to its impact on the project implementation

5.3.2 Model applicability

The various types of models and model philosophies are described in annex B.1 together with associated guidelines. Their applicability depends on the specific project requirements. The following main rules shall be observed:

- a. The number of models should be minimized and their reuse between different levels maximized to reduce costs;
- b. Parallel models should be utilized in order to suitably separate the test activities from each other and consequently to reduce risks of schedule slippage;
- c. Design verification (qualification) shall be carried-out on hardware and software which is representative of the end item configuration (e.g. prototype models, flight models in case of protoflight or hybrid approach);
- d. Workmanship verification (acceptance) shall be carried-out on the final hardware and software (e.g. flight models, spares);
- e. In exceptional cases, selected design parameters may be verified using development models, subject to customer concurrence.

5.4 Verification by test

A test programme shall be defined in line with the selected verification approach and model philosophy, on the basis of the verification strategies for the different requirement categories.

5.4.1 Test programme definition

In defining the test programme the following rules shall be taken into account:

- a. critical items and interfaces shall be tested early in the programme;
- b. allowance shall be made for the possibility of alternate paths (work around plans, contingencies);
- c. the test flow shall minimize the incidence of the regression testing;
- d. the reuse of models, simulators and support equipment shall be maximized;
- e. test feasibility shall be confirmed early in the programme.

5.4.2 Integration flow

The test program shall be coordinated with the integration flow to optimize both test and integration activities.

5.4.3 Integration tests

Interface or integrity tests shall be performed as part of the integration flow to check quality and status of the in-progress configuration.

If these tests have a verification purpose, they shall be included in the overall test programme.

5.4.4 Re-Integration tests

In response to the requirements of fault-finding or during post-landing phase in case of a multi-mission an equipment may have to be disassembled (de-integrated). This may also be necessary to carry out modifications or repairs.

In this case de-integration and re-integration shall be performed in a controlled manner and shall be properly documented. All interfaces which were broken by de-integration shall be re-verified and all relevant integration tests shall be repeated.

These tests are also called regression tests.

5.4.5 Test versus verification stages

The overall test programme shall cover development, qualification, acceptance, pre-launch, in-orbit and post landing testing as necessary; in this respect the test programme shall be tailored to each specific project or product and shall comply with the Standard Test Requirements defined in ECSS-E-10-03.

5.4.6 Test versus verification levels

The overall test programme shall cover the different verification levels as necessary; in this respect it shall be tailored to each specific project and product and shall comply with the Standard Test Requirements defined in ECSS-E-10-03.

5.4.7 Test matrices

Starting from the applicable verification matrix, test matrices should be established, to show the correlation of requirements categories with the test to be performed at the different levels in the various verification stages.

They identify the test verification events to be used for planning purposes.

5.5 Verification by analysis

An Analysis programme compatible with the selected verification approach shall be defined on the basis of the verification strategies for the various requirement categories.

5.5.1 Analysis programme definition

In defining the Analysis programme, the following factors shall be taken into account:

- a. the analytical technique shall be validated (verification by analysis is dependant on the quality of the analytical techniques and on the experience gained in using them);
- b. analysis may be used in support of test or vice versa;
- c. when analysis is supported by test data, testing shall be performed on a representative model;
- d. analysis for verification may be based on design analysis.

5.5.2 Verification analysis criteria

In performing the verification analyses, the following criteria shall be applied:

- The modelling system used shall be described, and its usage justified.
- The product configuration to which the analysis is applied shall be identified.
- All boundary conditions shall be stated.
- All assumptions used in the analysis shall be stated.
- The field of investigation and the range of validity of the results shall be defined.
- The analytical uncertainty shall be taken into account such that specified performance is demonstrated with an adequate margin.
- Analysis shall cover both the nominal and the worst case conditions.

5.5.2.1 Similarity criteria

For an article “A” to be considered as “verified by similarity” to an article “B” the following criteria shall be satisfied:

- Article “A” is a minor variation of article “B” (i.e. by substitution of parts and materials with equivalent reliability items).
- Articles “A” and “B” perform equivalent functions (with “B” qualified for an equivalent or longer operating life with variations only in terms of performance such as accuracy, sensitivity or input-output characteristics).
- Articles “A” and “B” are produced by the same manufacturer using identical tools and manufacturing processes (in case specific technology or knowledge are required).
- The environments encountered by article “B” during its verification life cycle are equal to or more severe than the verification environments intended for article “A”.
- Article “B” was not qualified by similarity.

5.5.3 Analysis versus verification stages

Verification by analysis should be used in the qualification stage only.

5.5.4 Analysis versus verification levels

Verification by analysis may be used at all verification levels.

5.5.5 Analysis matrices

Starting from the applicable verification matrix, Analysis matrices may be established, showing the correlation of the requirements categories with the analyses to be performed at the different levels.

These matrices identify the Analysis verification events to be used for planning purposes.

5.6 Verification by Review-of-design

A Review-of-design programme compatible with the selected verification approach shall be defined on the basis of the verification strategies for the different requirements categories.

5.6.1 Review-of-design programme definition

In defining the Review-of-design programme, the following factors shall be taken into account:

- a. The activity shall consist of reviewing a document or drawing for conformance to a specific requirement.

- b. The activity should be carried out simultaneously to the product design reviews.
- c. The activity may include the review of lower level records (e.g. requirement verified by test at lower level).

5.6.2 Review-of-design versus verification stages

Verification by Review-of-design should be used in the qualification stage only.

5.6.3 Review-of-design versus verification levels

Verification by Review-of-design may be used at all verification levels.

5.6.4 Review-of-design matrices

Starting from the applicable verification matrix, Review-of-design matrices may be established, showing the correlation of the requirement categories with the Review-of-design activities to be performed at the different levels.

These matrices identify the Review-of-design verification events to be used for planning purposes.

5.7 Verification by inspection

An Inspection programme compatible with the selected verification approach and model philosophy shall be defined on the basis of the verification strategies for the different requirement categories.

5.7.1 Inspection programme definition

In defining the Inspection programme the following factors shall be taken into account:

- a. The activity shall consist of inspecting hardware and software for conformance to applicable documentation.
- b. Inspection could be complementary to Review-of-design.
- c. The activity should be carried out together with quality assurance tasks during manufacturing or integration process.
- d. The activity may be performed by the crew during in-orbit verification.

5.7.2 Inspection versus verification stages

Verification by Inspection may be used in all stages.

5.7.3 Inspection versus verification levels

Verification by Inspection may be used at all verification levels.

5.7.4 Inspection matrices

Starting from the applicable verification matrix, Inspection matrices may be established, showing the correlation of the requirement categories with the inspections to be performed at the different levels in the applicable verification stages

These matrices identify the Inspection verification events to be used for planning purposes.

5.8 Re-flight verification

5.8.1 Re-flight verification programme

A new verification programme based on the previous flight shall be established by reviewing and assessing existing documentation, on the basis of the requirements for the new flight and by inspecting the hardware and software to be reflown.

5.8.2 Re-flight verification activities

The following covers both, re-flight with or without design changes.

For planning and identification activities the following documents shall be reviewed, analysed and assessed.

- a. **End Item Data Package (EIDP)**
The EIDP shall be checked item by item to identify re-verification activities.
- b. **FMECA**
The FMECA shall be reviewed for validity.
- c. **Historical Records** shall be analysed for events during integration, test, mission, re-integration and transport.
- d. **Nonconformance (NCR) and Deviations** shall be screened for potential transfer to a “new” NCR/deviation (see ECSS-Q-20-09).
The previous NCR/deviation-No. shall be recorded as reference on the new established NCR/deviation for traceability.
- e. **Mission Anomaly and Failure Reports** shall be reviewed for their impact on re-flight verification.
- f. **Specifications and I/F Requirement Documents**
For the planned re-flight of a product, specifications and I/F requirement documents shall be reviewed with respect to applicability of existing requirements, new requirements, new accommodation, new environment and activities for refurbishment including design changes.
This may result in an update of the specification with new or changed verifications.
- g. The **Structural Analysis, the Fracture Control Analysis, or the Life Limited Item List** shall identify those areas (e.g. joints) which requires access (requirement for de-integration) for visual inspection or non-destructive-inspection before re-flight.

(This page is intentionally left blank)

Verification implementation

The following general aspects shall be considered by those involved in establishing and implementing a verification programme:

- a. Ensure the definition of correct verification criteria for each requirement by participating in the preparation of specifications.
- b. Verification has an impact on the design (e.g. modularity, testability, accessibility).
- c. Ensure a coherent approach to verification implementation throughout the various levels in order to achieve a verified product.
- d. Ensure early verification of critical items to reduce the risks of late failure identification.
- e. Optimize the design and use of ground support equipment, simulators and test software (e.g. re-use for flight operations).
- f. Minimize cost and schedule by avoiding duplication of tasks.
- g. Optimize the use of test facilities.
- h. Plan for feedback to the verification activity from the in-orbit results in case of multi-mission projects or recurring products.
- i. Ensure suitable coverage of the interface verification.
- j. Investigate innovative solutions which may reduce overall verification costs.
- k. Provide adequate visibility and objective evidence of verifications performed.

6.1 Verification responsibilities

The supplier shall assign clear responsibility for the implementation of the Verification Programme.

The verification personnel shall be involved from the early project phases in order to follow a concurrent engineering approach which avoids separation between verification requirement definition and verification implementation.

Typical verification responsibilities are described in annex B.5.

6.1.1 Verification Control Board (VCB)

The VCB shall be established with the participation of customer and supplier.

The objective of the VCB is to assess and approve the status of the verification process including the approval of the verification close-out through the VCD.

Verification status should be carried out periodically during the execution of the project implementation and on the occasions of the important reviews.

6.1.2 Test Readiness Review (TRR) and Post Test Review (PTR)

The supplier shall convene reviews to declare the readiness for test and to review the preliminary results in order to declare the test completion.

These reviews shall be carried out prior to and after each main integration and test activity (see ECSS-Q-20).

The customer should be invited to attend each review.

6.1.3 Nonconformance Review Board (NRB)

When a major nonconformance is detected during verification activities, a Nonconformance report shall be written and processed by the NRB (see ECSS-Q-20-09).

In particular, the use of a failure questionnaire is strongly recommended to collect statistical information for entry into a data base which holds verification lessons learnt as a result of verification activities.

6.1.4 Verification responsibilities documentation

Verification responsibilities shall be documented by the supplier and approved by the customer (see 6.5 for documentation details).

No verification process activity should start before the approval of the governing document .

6.2 Verification planning

On the basis of the logic of the verification process and taking into account the model philosophy, the verification strategies, the integration and test programme, the analysis/review-of-design/inspection programme and the identified verification tools, a verification planning activity shall be established which synchronizes the verification activities with the project milestones and programmatic constraints.

The level of detail varies with the type of product and in relationship with the actual phase of the project.

6.2.1 Verification planning content

The verification planning activity shall take into account the following elements:

- product tree (starting from the lowest level);
- applicable models;
- estimated time effort for procurement/design/manufacturing of each model;
- utilization of models (in line with the model philosophy);
- estimated time effort for integration of models;
- selected test programme and sequences at different levels with estimated time and resources;

- Analysis, Review-of-design and Inspection activities suitably combined on the basis of the verification strategies and estimated time and resources;
- the activities and time associated with the procurement of the required verification tools;
- the project milestones and the relevant verification output.

6.2.2 Phasing with project life cycle

The verification planning shall be properly phased with the project life cycle.

Figure 1 shows a typical verification process with its output in relation to the project phases and milestones (as described in ECSS-M-30A).

Guidelines for verification activities are described in annex B.4.

6.2.3 Verification planning documentation

Dedicated documentation shall be generated by the supplier to provide proper evidence of the verification process planning and shall form the basis of the subsequent implementation (for details on documentation see subclause 6.5.1.3).

The documentation shall be approved by the customer.

6.3 Verification tools

The degree of verification applied to tools used to support the verification programme shall be established.

Formal verification procedures shall be applied to tools which are specified as deliverable items.

6.3.1 Tools validation

Evidence that the tools are suitable for their intended use shall be provided.

6.3.2 Ground Support Equipment (GSE)

Ground Support Equipment is used to support assembly, integration, test, handling, transport and launch campaign activities.

6.3.2.1 GSE validation

The GSE shall be validated based on expected environmental conditions and operational constraints.

Hazards to personnel, flight hardware, facilities and environments shall be processed in accordance with ECSS-Q-40.

6.3.2.2 GSE test program

A test programme shall be established in order to validate the functions and performance of all GSE equipment and the compatibility of the interfaces with flight items and facilities.

6.3.2.3 Modified or redesigned GSE

Modified or redesigned GSE, or GSE used in a new application, shall be revalidated to the extent necessary prior to use.

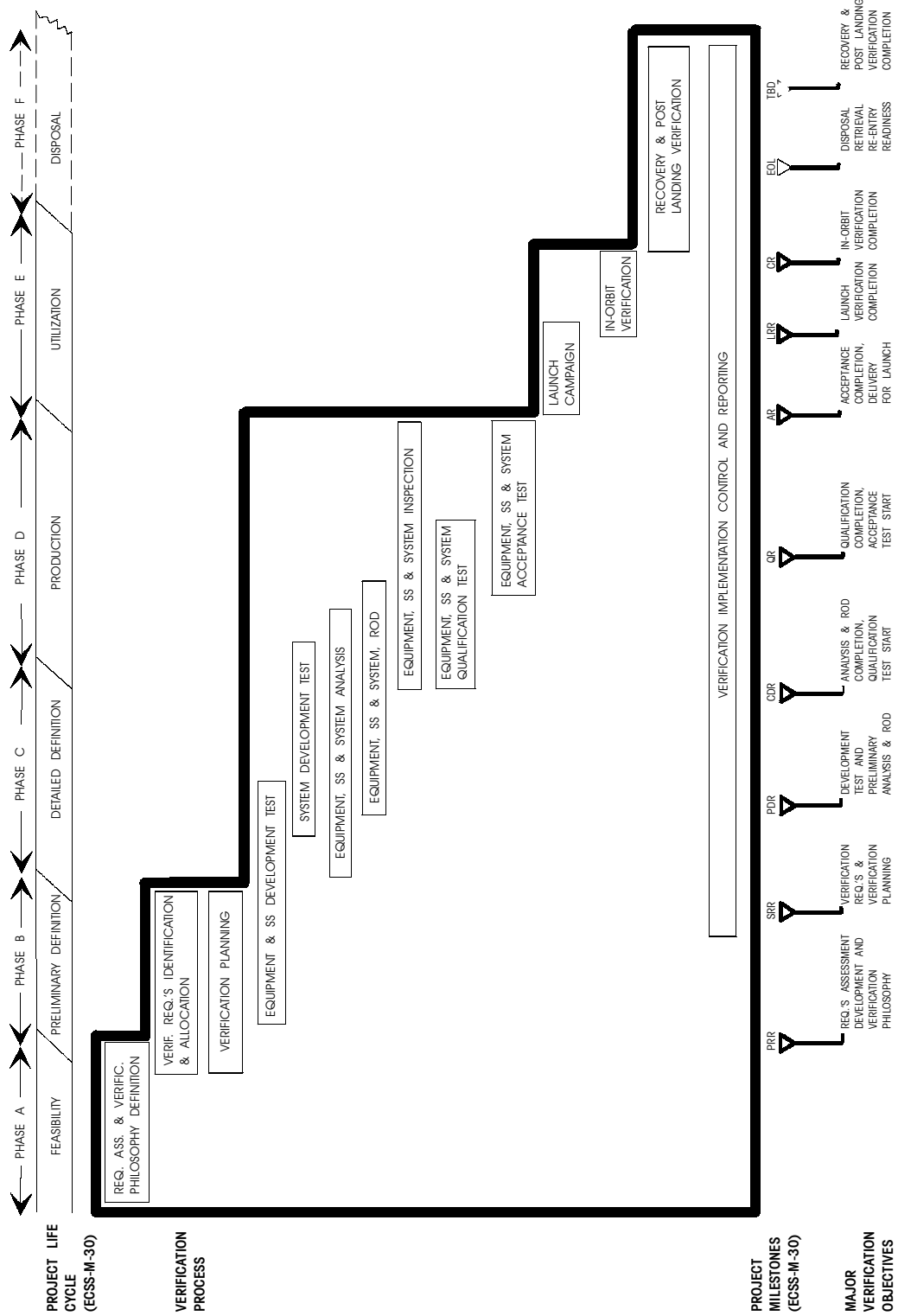

Figure 1: Typical verification process phasing with the project life cycle

6.3.3 Software Validation Facility (SVF)

The SVF shall provide a test bench able to support all phases of onboard software test and validation. It is used prior to the integration of the software into the target hardware during the software development activity, as a tool to support independent software validation and to support software maintenance.

In particular, the SVF shall support:

- a. modelling of the environment in which the software has to operate (including the capability for margins and error injection);
- b. verification of the onboard software in operational conditions, using non-intrusive methods;
- c. debugging and trouble-shooting of onboard software.

6.3.3.1 SVF validation

The SVF shall be validated by comparing the results of test simulation activities with the required performance.

6.3.4 Simulators

Simulators may be used at all levels to simulate items, functions, conditions or interfaces in absence of the real hardware and software during integration and test activities.

6.3.4.1 Simulators validation

Validation shall demonstrate that the simulator characteristics are consistent with the test to be supported.

6.3.5 Software tools for verification by analysis

Software tools are often utilized to carry out the analytical verification.

6.3.5.1 Analytical software tools validation

Tools already validated for similar applications shall be preferred.

Their suitability for the intended application shall be assessed.

Non-validated tools shall be subjected to a validation process prior to their use.

6.3.6 Integration and test facilities and equipment

Integration and test facilities and laboratory test equipment may be used to support the integration and test programme.

6.3.6.1 Integration and test facilities and equipment validation

The suitability of such facilities and equipment in terms of performance and calibration shall be demonstrated as part of the overall integration and test process.

6.4 Verification execution and control

The implementation of the verification programme shall be monitored following a day-by-day verification control concept oriented to identify potential problems, with the object of reducing risk of cost increasing and schedule slippage.

6.4.1 Verification Data Base

The verification process should be supported by a verification data base which allows:

- systematic traceability of all requirements at each verification level;
- the possibility to perform coherence checks between products and levels;
- monitoring of the verification process throughout the project life cycle;

- identification of impacts at the various levels in case of change of requirements or criticalities during lower level verification;
- immediate and flexible reporting of data in support of the preparation of the project verification documentation;
- minimization of repetitive jobs;
- elimination of errors;
- integration into the higher level of the lower level verification data.

6.4.2 Re-verification

Each requirement should be verified only once, but additional re-verification shall be performed in the following cases:

- following failure and repair as decided by NRB (see ECSS-Q-20-09);
- after disassembly or demating;
- for products to be re-flown;
- after refurbishment, maintenance or design changes;
- following changes of requirements after initial verification.

6.4.3 Verification execution evidence

The documented evidence of verification or re-verification performed shall be provided by the supplier to the customer (for details on documentation see subclause 6.5).

6.4.4 Verification close-out

The documented evidence of verification close-out shall be provided by the supplier and submitted for agreement by the customer (for details on documentation see subclause 6.5). If a document provided for verification close-out has been approved the related verification shall be considered closed.

6.4.5 Test effectiveness

In order to optimize the test activities an evaluation shall be performed considering the ability of specific tests to detect failures (test effectiveness).

The optimization of test activities shall consider associated costs and risks.

The evaluation of the test effectiveness should be based on statistical data.

This evaluation is based on the fact that the failures detected during ground testing are only a portion of the spacecraft infant mortality failures; some failures escape testing and they may end up as early flight failures.

The most effective tests shall be selected to reduce early flight failures.

6.4.6 Verification lessons learnt

The lessons learnt from the verification process (including test effectiveness results) shall be collected and fed forward into the definition of the next verification programme.

6.5 Verification documentation

The verification process and its implementation activities shall be documented by means of a specific set of verification documents.

This activity is a compromise between minimizing documentation effort, to meet cost constraints and the requirement to properly trace the verification events, which is fundamental in order to reduce risks and to facilitate recovery actions in case of problems.

The verification process documentation is summarized in Figure 2.

NOTE The arrows reflect logical connection between documents and do not necessarily represent the process flow.

With this approach, taking as an example a system thermal requirement to be verified with thermal balance test and associated analysis in qualification stage, the following documentation steps should apply:

- The requirement is identified in the relevant system specification together with its verification entries (i.e. “T” and “A” methods at “System” level in “Qualification” stage) in the associated verification matrix.
- The system assembly, integration and verification plan defines the relevant verification events and associated flows (i.e. thermal balance test and thermal analysis), outlining them in the dedicated activity sheets.
- The specific test requirements, which take into account project general test requirements contained in the test requirement specification, are subsequently detailed in a thermal balance test specification which is followed by several test procedures with the relevant step-by-step instructions.
- The test results are summarized in the dedicated test report.
- In parallel the required analysis is carried out in relationship to the test activities (i.e. test prediction/correlation) and the results presented in the relevant analysis report.
- The synthesis of the performed verification activities (test plus analysis) is described in the verification report.
- The system verification control document currently traces the status of the verification implementation and finally gives the evidence of the requirement verification close-out.

6.5.1 Verification documents

The applicability of the following verification documents to projects and products shall be considered (DRD’s number refers to annex A).

6.5.1.1 Verification matrix

The verification matrix shall define for each requirement the corresponding verification method at the applicable verification level in the relevant verification stage. It may be included in the product specification.

The verification matrix is the starting point for the VCD.

This document shall be in accordance with the DRD in annex C.

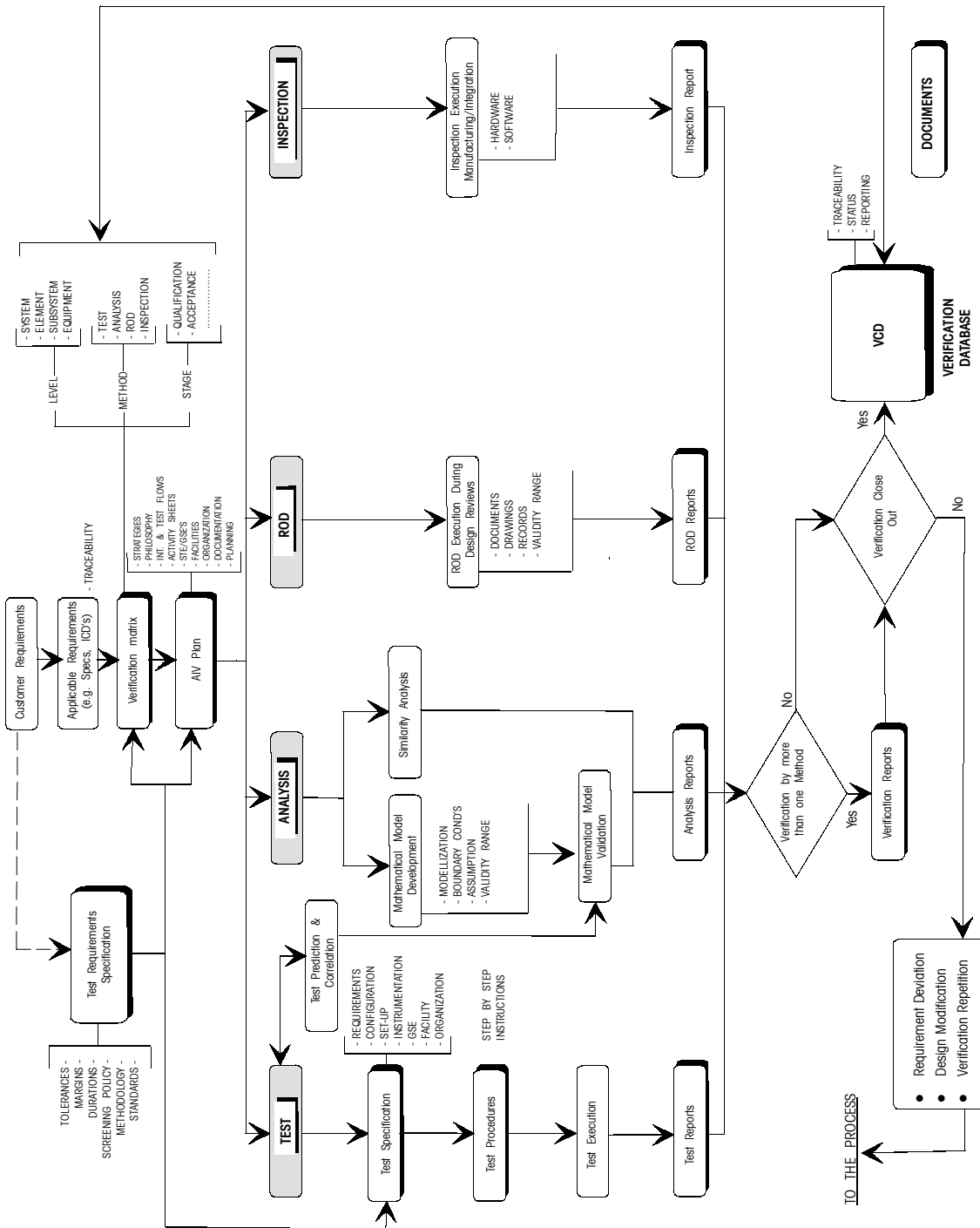

Figure 2: Verification documentation

6.5.1.2 Test requirement specification

The test requirement specification is typically a system support specification applicable to all verification levels through the relevant product specifications (e.g. system, subsystem and equipment specification).

It shall contain the general test requirements in terms of type of tests, sequences, margins, durations, tolerances, screening policy and methodology.

This document should be a tailored version of ECSS-E-10-03 (Testing). For details see ECSS-E-10-03.

6.5.1.3 Assembly Integration and Verification (AIV) plan

The AIV plan shall be the master plan for the project verification process and shall demonstrate how the requirements will be verified by a coherent implementation approach. This plan includes the assembly, integration and test planning.

In specific circumstances (e.g. project with a complex production cycle) assembly and integration plan may be a separated document.

For certain lower level product (e.g. simple equipment) the AIV plan could be practically coincident with the test plan.

It shall contain the overall verification approach, the model philosophy, the hardware matrix, the verification strategies for each requirement category, the analysis, review-of-design and inspection programme, the assembly integration and test programme, the verification activity sheets and the relevant planning, the selected test facilities, the verification tools, the verification control methodology, the involved documentation, the verification management and organization. The document shall be in accordance with the DRD in annex D.

6.5.1.4 Verification Control Document (VCD)

The Verification Control Document shall list all the requirements to be verified with the selected methods in the applicable stages at the defined levels (in this sense it replaces the verification matrix) and provides traceability during the phase C/D, how and when each requirement is planned to be verified and is actually verified. The document shall be in accordance with the DRD in annex E.

The VCD requires formal concurrence by the customer and becomes part of the EIDP as detailed in ECSS-Q-20.

6.5.1.5 Test specification

The test specification may be prepared for specific test activity(ies) described in the AIV plan activity sheets with the objective to detail the test requirements for special purposes (e.g. to interface with a test facility).

This document reflects an intermediate step in the test process definition between the overall planning (AIV plan) and the specific test procedure. It could be combined with the above documents depending on actual project requirements.

The test specification contains the activity objectives, the selected approach, the article configuration, the set-up description, the necessary GSE, the equipment and instrumentation, the conditions for the activity, the required facilities, the sequence of activities with the detailed verification requirements, the success criteria, the organization and responsibilities, the involved documentation, the relationship with product assurance activities, the schedule. The document shall be in accordance with the DRD in annex F.

6.5.1.6 Test procedure

The test procedure shall provide detailed step-by-step instructions for conducting test activities in agreement with the relevant test requirements.

The test procedure shall contain the activity objective, the applicable documents, the references to the relevant test specification, the participants required, the article and tools configuration list, the step-by-step procedures.

The document shall be in accordance with the DRD in annex G.

6.5.1.7 Test report

The test report shall describe test performance, results and conclusions in the light of the test requirements.

This report shall contain the introduction, the test description, the test results including the as-run test procedures, the considerations and conclusions with particular emphasis on the close-out of the relevant verification requirements including any deviation.

The document shall be in accordance with the DRD in annex H.

6.5.1.8 Analysis report

The analysis report shall describe, for each analysis, the relevant assumptions, utilized methods, techniques and results.

It shall contain proper evidence that the relevant requirements are verified and the indication of deviations.

The document shall be in accordance with the DRD in annex I.

6.5.1.9 Review-of-design report

The review-of-design report shall describe each verification activity performed for reviewing documentation.

It shall contain proper evidence that the relevant requirements are verified and the indication of any deviation.

The document shall be in accordance with the DRD in annex J.

6.5.1.10 Inspection report

The inspection report shall describe each verification activity performed for inspecting hardware.

It shall contain proper evidence that the relevant requirements are verified and the indication of any deviation.

The document shall be in accordance with the DRD in annex K.

6.5.1.11 Verification report

The verification report may be prepared in case that more than one of the defined verification methods are utilized to verify a requirement or a specific set of requirements.

It shall explain the approach followed and how the verification methods were combined to achieve the verification objectives.

The positive achievement constitutes the completion of verification for the particular requirement.

The document shall be in accordance with the DRD in annex L.

6.5.2 Other documents

In addition to the above major documentation, other off-line documents may be part of the verification process to provide the necessary traceability and event record, such as: test configuration list (TCL), end-item data packages, logbooks (including work items and deviation work items), nonconformance reports (NCRs), request for waivers (RFWs), manuals, simulation plans, verification tools documentation.

(This page is intentionally left blank)

Annex A (normative)

Verification documents

In line with the requirements of subclause 6.5, the following Document Requirements Definitions as listed in the DRD Index of Table A-1 are applicable to the verification documentation.

The table includes the DRD number, title, applicability to project phases (as described in ECSS-M-30), delivery and remarks.

The DRDs, the applicability to project phases and the delivery events have to be tailored for the specific project in line with the requirements of this standard.

As a general rule, the content of the verification documentation shall be clear and precise, without possibility of different interpretation.

Table A-1: ECSS-E-10-02 DRD Index

| DRD Number | DRD Title | Applicable to (phase) | | | | | | | Deliver at | Remarks |
|-----------------------|---|-----------------------|---|---|---|---|---|---|--|--|
| | | 0 | A | B | C | D | E | F | | |
| ECSS-E-10-02A annex C | Verification matrix | | X | X | X | | | | PRR, SRR, PDR, CDR | Will be eventually incorporated in the VCD as soon as frozen |
| ECSS-E-10-02A annex D | Assembly, Integration and Verification (AIV) plan | | X | X | X | X | X | X | PRR, SRR, PDR, CDR, QR, AR, LRR, EOL | Includes Assembly, Integration and Test plan |
| ECSS-E-10-02A annex E | Verification Control Document (VCD) | | | X | X | X | X | X | Periodically as a minimum at SRR, PDR, CDR, QR, AR, LRR, EOL | |
| ECSS-E-10-02A annex F | Test specification | | | | X | X | | | Several months before test | |
| ECSS-E-10-02A annex G | Test procedure | | | | X | X | X | X | Few weeks before test | |
| ECSS-E-10-02A annex H | Test report | | | | X | X | X | X | Few weeks after tests | |
| ECSS-E-10-02A annex I | Analysis report | | | | X | X | X | X | Few weeks after analysis | |
| ECSS-E-10-02A annex J | Review-of-Design report | | | | X | X | | | Few weeks after review of design | |
| ECSS-E-10-02A annex K | Inspection report | | | | X | X | X | X | Few weeks after inspection | |
| ECSS-E-10-02A annex L | Verification report | | | | X | X | X | X | Few weeks after completion of the last verification activities | |

Annex B (informative)

Verification guidelines

B.1 Model and model philosophy definition guidelines

In line with the requirements of subclause 5.3, the following guidelines are intended to help the definition of the models involved in the verification process and the selection of the associated model philosophy. Examples of typical models and philosophies applied to different type of projects are presented together with suggestions for their effective application. The concept of hardware matrix and associated data is also introduced.

B.1.1 Models description

Various types of models can be employed according to verification requirements, and a short description of the major physical models used is given.

These models shall be maintained under configuration control (except models used for development purposes, if not otherwise specified).

Table B-1 provides a schematic summary of the models with related objectives, representativeness and applicability.

B.1.1.1 Mock-up (MU)

Mock-ups are used in support to design definition for overall architecture analyses, configuration design and assessment, interface control and definition, human factors assessment, operational procedures evaluation, layout optimization.

According to their representativeness, mock-ups are classified as:

- **Low fidelity:** to be used in the verification initial phases (generally, mock-ups for human factors engineering requirement development activities are low fidelity type).
- **High fidelity:** under configuration control in all areas where interface control and flight hardware manufacturing support is provided (e.g. area of utility routing, connector brackets, attach points).

The mock-ups are intended as incremental tools, i.e. they are progressively upgraded with time to reflect the final configuration, as applicable.

Mock-ups intended for human factors evaluation are also used for parabolic flight, buoyancy and swimming pool tests. Their representativeness depends on the type of test to be performed.

B.1.1.2 Development Model (DM)

Development models are used in support to the development.

In general these models are necessary in the areas of new design or where substantial redesign is required.

They are applicable to every type of product (e.g. electronic box, mechanisms, structural parts and thermal equipment) and may be subjected to functional and environmental testing.

Development models of subsystems are also envisaged such as: Thermal Control active control loop breadboards, attitude and orbit control system/guidance and navigation control benches.

B.1.1.3 Integration Model (IM)

The integration models (sometimes called also electrical models) are functionally representative of the end items in terms of electronic and software.

They are used for functional and interface tests and for failure mode investigations.

Commercial parts are utilized, but they are typically procured from the same manufacturer of the hi-rel parts to be used in the flight end item.

B.1.1.4 Suitcase

The suitcase is designed to simulate functional performance both in terms of data handling (e.g. telecommand and telemetry as formats, bit rates, packet type) and of radiofrequency.

The suitcase shall include all the necessary functional simulations (e.g. decoder, transponder).

The suitcase is used to test the links with the ground segment or other external infrastructures.

B.1.1.5 Structural Model (SM)

The structural model is fully representative of the end item for structural aspects.

It is used for qualification of the structural design and for mathematical models correlation.

Generally the system structural model consists of a representative structure, with structural dummies of the equipment. It includes also representative mechanical parts of other subsystems (e.g. mechanisms, solar panels).

SM is also used for a final validation of test facilities/GSE and related procedures.

B.1.1.6 Thermal Model (TM)

The thermal model is fully representative of the thermal properties of the end item.

It is used for the qualification of the thermal design and for the correlation of mathematical models.

Generally the system thermal model consists of a representative structure with thermal dummies of the equipment. It includes also representative thermal parts of other subsystems.

B.1.1.7 Structural-Thermal Model (STM)

The structural-thermal model combines the objectives of the structural model and thermal model.

It consists, at system level, of a representative structure equipped with thermo-structural dummies of equipment.

On the other hand, the structural-thermal model can be also a structural model refurbished for thermal verification purposes after structural qualification (in this event no potentially destructive tests are performed on the SM).

B.1.1.8 Engineering Model (EM)

The engineering model is flight representative in form, fit and function, without full redundancy and hi-rel parts.

The engineering models are used for functional qualification, except redundancy verification, failure survival demonstration and parameter drift checking.

The EM is also used for final validation of test facilities and GSE and the related procedures.

B.1.1.9 Engineering Qualification Model (EQM)

The engineering qualification model fully reflects the design of the end item, except for the parts standard (commercial parts are allowed, but these are typically procured from the same manufacturer of the hi-rel parts).

The engineering qualification models are used for functional performance qualification (including verification of procedures for failure detection, confirmation, isolation and recovery and for redundancy management) and EMC testing.

They may also be used for environmental testing if the project authority accepts the risk.

B.1.1.10 Qualification Model (QM)

The qualification model fully reflects the end item design in all aspects.

The qualification models are used for full level functional and environmental qualification tests.

They are required only for equipment/subsystems of new design or requiring delta qualification for adaptation to the project.

B.1.1.11 Flight Model (FM)

The flight model is the flight end item configured as described in ECSS-M-40. It is subjected to formal functional and environmental acceptance testing.

B.1.1.12 Protoflight Model (PFM)

The protoflight model is the flight end item on which a partial or complete protoflight qualification test campaign is performed before flight.

The applicability of a protoflight model, when mechanisms are present, shall be carefully evaluated (limited life problems).

B.1.1.13 Flight Spare (FS)

The flight spare is the spare end item for flight. It is subjected to formal acceptance testing.

Refurbished qualification items may be used as flight spares. In general, qualification items that have been identified by a FMECA (see ECSS-Q-30) as a single point failure in the severity category "loss of mission", should never be used for flight.

B.1.1.14 Function Oriented Models

The function oriented models are dedicated to the qualification of particular functional requirements.

They are end item representative as necessary for the limited qualification objectives.

The definition of these models depends on project characteristics and verification requirements.

Examples of function oriented models are:

- software validation facility;
- aerodynamic models;
- robotics and automation models;
- ground segment functional models.

B.1.1.15 Training Model

Training models are dedicated to development and training of flight procedures. Therefore, they are typically a functional representative of the flight model modified to be capable to function under natural gravity.

Training models may be used to:

- train flight crew and ground personnel;
- develop and verify procedures;
- establish training records;
- perform baseline data collection.

B.1.1.16 Simulators

Simulators are dedicated to the validation of operational scenarios whenever the actual system constituents are not available. Typical simulators and their uses can be:

- I/F simulators: structural interface device, integration testing;
- environmental simulators: environmental testing, operational scenario validation (e.g. solar chambers, water submersion model);
- system simulators: operational scenario validation, integrated flight-ground operations training, mission simulations, joint integrated simulations.

Depending on the individual mission and purpose common model fidelity may range from mock-up to simple front-end fidelity or to flight representative.

B.1.1.17 Other man-oriented models

These models are dedicated to the qualification of particular human factors engineering requirements.

Their representativeness is limited, depending on qualification objectives.

B.1.2 Model philosophies description

Several types of model philosophies may be employed according to verification requirements.

A short description of the major model philosophies utilized in the verification process is given in what follows.

B.1.2.1 Prototype Philosophy

This approach is generally used in projects for which all affordable measures are taken to achieve minimum risk. The typical characteristics of these projects are:

- new and/or complex design;
- impossibility to be recovered or repaired after launch;

- special mission requirements.

The prototype approach makes an extensive use of the above defined models to cover verification necessities.

The advantages of this approach are:

- low risks;
- possibility to perform parallel activities on different models;
- completion of qualification activities prior to acceptance;
- possibility to use QM or EQM (see Table B-1) as an integration spare during high level activities.

The disadvantage is high costs.

On the basis of project requirements, the related model philosophy shall be tailored.

Figures B-1 and B-2 show examples of prototype philosophies for unmanned and manned projects respectively.

In the figures the different models and their flow at the several verification levels together with the respective test activities and the final utilization are identified.

In particular the Figure B-1 shows the common case in which, after the thermal/structural qualification, parts of the STM (namely structure and thermal control) are utilized to complete EM in addition to EM/QM equipment. It shall be noted that after the system electrical/functional qualification the EM is used for ground support to flight operation. Feedback is also allowed from qualification on the FM manufacturing.

Figure B-2 shows a typical model philosophy for a manned project, in which element level mock-ups are utilized for interface/layout optimization and human factor engineering dedicated verifications. High fidelity mock-up in conjunction with IM will be finally utilized for crew training on ground.

In addition, after system functional, thermal and structural interface verification between elements, EM and STM will be used for flight simulation on ground.

The FM will be subjected to an orbital flight test for final in-orbit verification.

Table B-1: Model definition

| Model | Objectives | Representativeness | Applicability | Remarks |
|---------------------------------------|---|---|--|--|
| Mock-Up (MU) | <ul style="list-style-type: none"> I/F layout optimization/ assessment Integration procedure validation Accommodation checks | <ul style="list-style-type: none"> Geometrical configuration Layouts Interfaces | <ul style="list-style-type: none"> System/element levels | <ul style="list-style-type: none"> According to their representativeness MUs are classified as: <ul style="list-style-type: none"> Low fidelity High fidelity (to be maintained under configuration control) |
| Development Model (DM) | <ul style="list-style-type: none"> Confirmation of design feasibility | <ul style="list-style-type: none"> Total conformity with functional electrical & S/W req. in agreement with verif. objectives (size, shape & I/Fs could not be representative) | <ul style="list-style-type: none"> All levels | <ul style="list-style-type: none"> Development testing Sometime it is also called breadboard |
| Integration Model (IM) | <ul style="list-style-type: none"> Functional development S/W development Procedure validation | <ul style="list-style-type: none"> Functional representativeness Commercial parts Simulators of missing parts | <ul style="list-style-type: none"> All levels | <ul style="list-style-type: none"> Development testing It could be considered something in between a mock-up and an EM Sometime is called also Electrical Model |
| Suitcase | <ul style="list-style-type: none"> Simulation of functional & RF performances | <ul style="list-style-type: none"> Flight design Commercial parts Functional representativeness | <ul style="list-style-type: none"> Equipment level System level | <ul style="list-style-type: none"> Qualification testing |
| Structural Model (SM) | <ul style="list-style-type: none"> Qualification structural design Validation of structural mathematical model | <ul style="list-style-type: none"> Flight standard with respect to structural parameters Equipment structural dummies | <ul style="list-style-type: none"> SS level (structure) Sometime it could be considered system level if involves other SS or is merged with the system test flow | <ul style="list-style-type: none"> Qualification testing |
| Thermal Model (TM) | <ul style="list-style-type: none"> Qualification of thermal design Validation of thermal mathematical model | <ul style="list-style-type: none"> Flight standard with respect to thermal parameters Equipment thermal dummies | <ul style="list-style-type: none"> SS level (thermal control) Sometime it could be considered system level if involves other SS or is merged with the system test flow | <ul style="list-style-type: none"> Qualification testing |
| Structural-Thermal Model (STM) | <ul style="list-style-type: none"> SM & TM objectives | <ul style="list-style-type: none"> SM & TM representativeness Equipment thermo structural dummies | <ul style="list-style-type: none"> System level | <ul style="list-style-type: none"> Qualification testing |
| Engineering Model (EM) | <ul style="list-style-type: none"> Functional qualification failure survival demonstration & parameter drift checking | <ul style="list-style-type: none"> Flight representative in form-fit-function Flight design without redundancies and hi-rel parts | <ul style="list-style-type: none"> All levels | <ul style="list-style-type: none"> Partial functional qualification testing |
| Engineering Qualification Model (EQM) | <ul style="list-style-type: none"> Functional qualification of design & I/Fs EMC | <ul style="list-style-type: none"> Full flight design MIL-Grade parts procured from the same manufacturer of hi-rel parts | <ul style="list-style-type: none"> All levels | <ul style="list-style-type: none"> Functional qualification testing |
| Qualification Model (QM) | <ul style="list-style-type: none"> Design qualification | <ul style="list-style-type: none"> Full flight design & flight standard | <ul style="list-style-type: none"> Equipment level SS level | <ul style="list-style-type: none"> Qualification testing |
| Flight Model (FM) | <ul style="list-style-type: none"> Flight use | <ul style="list-style-type: none"> Full flight design & flight standard | <ul style="list-style-type: none"> All levels | <ul style="list-style-type: none"> Acceptance testing |
| Protoflight Model (PFM) | <ul style="list-style-type: none"> Flight use design qualification | <ul style="list-style-type: none"> Full flight design & flight standard | <ul style="list-style-type: none"> All levels | <ul style="list-style-type: none"> Protoflight qualification testing |
| Flight Spare (FS) | <ul style="list-style-type: none"> Spare for flight use | <ul style="list-style-type: none"> Full flight design & flight standard | <ul style="list-style-type: none"> Equipment level | <ul style="list-style-type: none"> Acceptance testing |
| Function Oriented Models | <ul style="list-style-type: none"> Qualification against the applicable functional requirements | <ul style="list-style-type: none"> Flight representative as necessary for the limited qualification objectives | <ul style="list-style-type: none"> All levels | <ul style="list-style-type: none"> Qualification testing oriented to a specific function or requirement |
| Training Model | <ul style="list-style-type: none"> Flight training baseline data | <ul style="list-style-type: none"> Flight representative with modifications to allow for normal gravity operation | <ul style="list-style-type: none"> All levels | <ul style="list-style-type: none"> Qualification testing oriented to specific HFE requirements |
| Simulators | <ul style="list-style-type: none"> Validation of operations concepts | <ul style="list-style-type: none"> Flight representative as necessary for the applicable qualification objectives | <ul style="list-style-type: none"> All levels | <ul style="list-style-type: none"> Qualification testing oriented to specific HFE requirements |
| Other Man Oriented Models | <ul style="list-style-type: none"> Qualification against the applicable HFE requirements | <ul style="list-style-type: none"> Flight representative as necessary for the limited qualification objectives | <ul style="list-style-type: none"> All levels | <ul style="list-style-type: none"> Qualification testing oriented to specific HFE requirements |

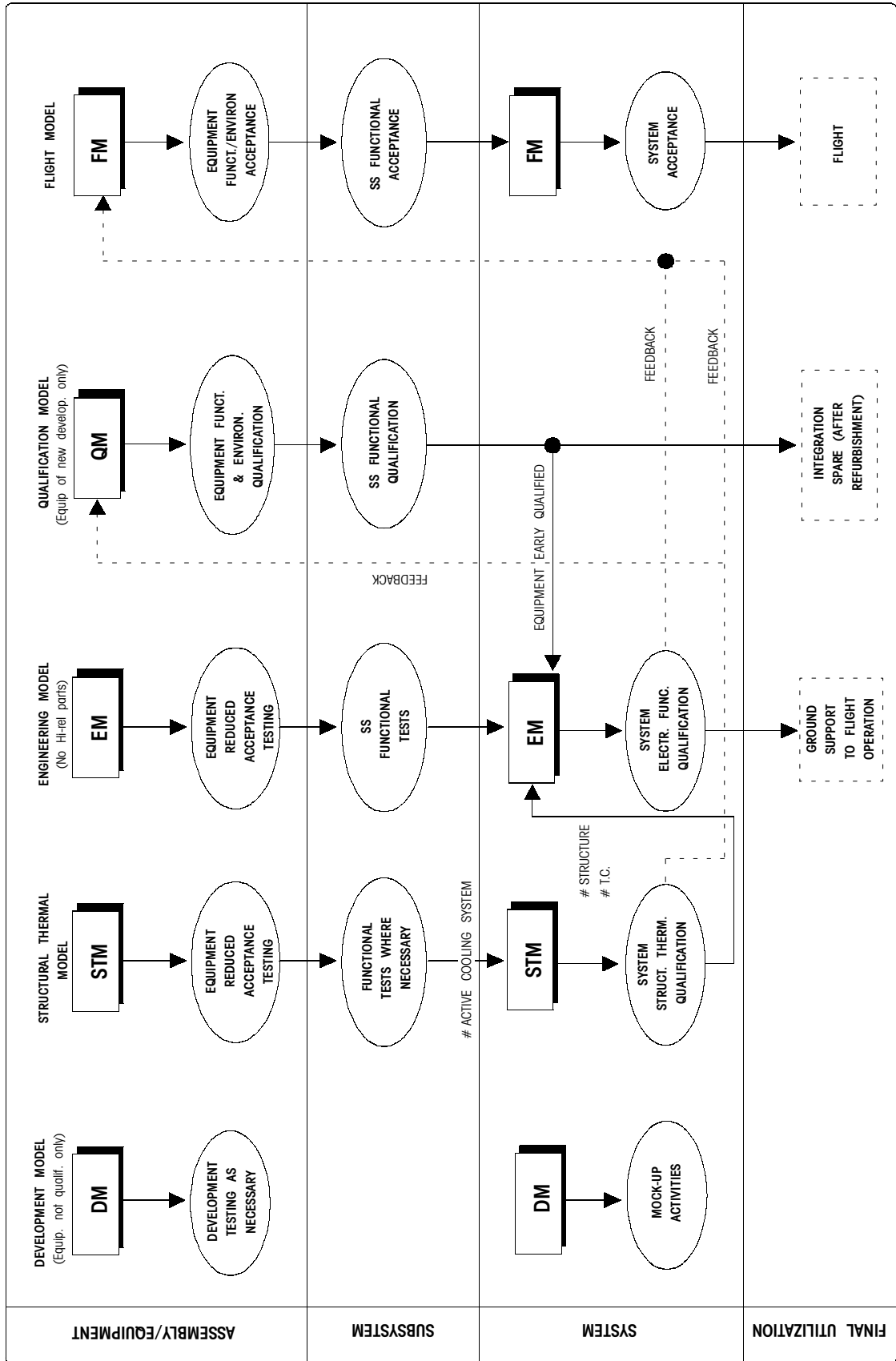

Figure B-1: Unmanned Project Model philosophy

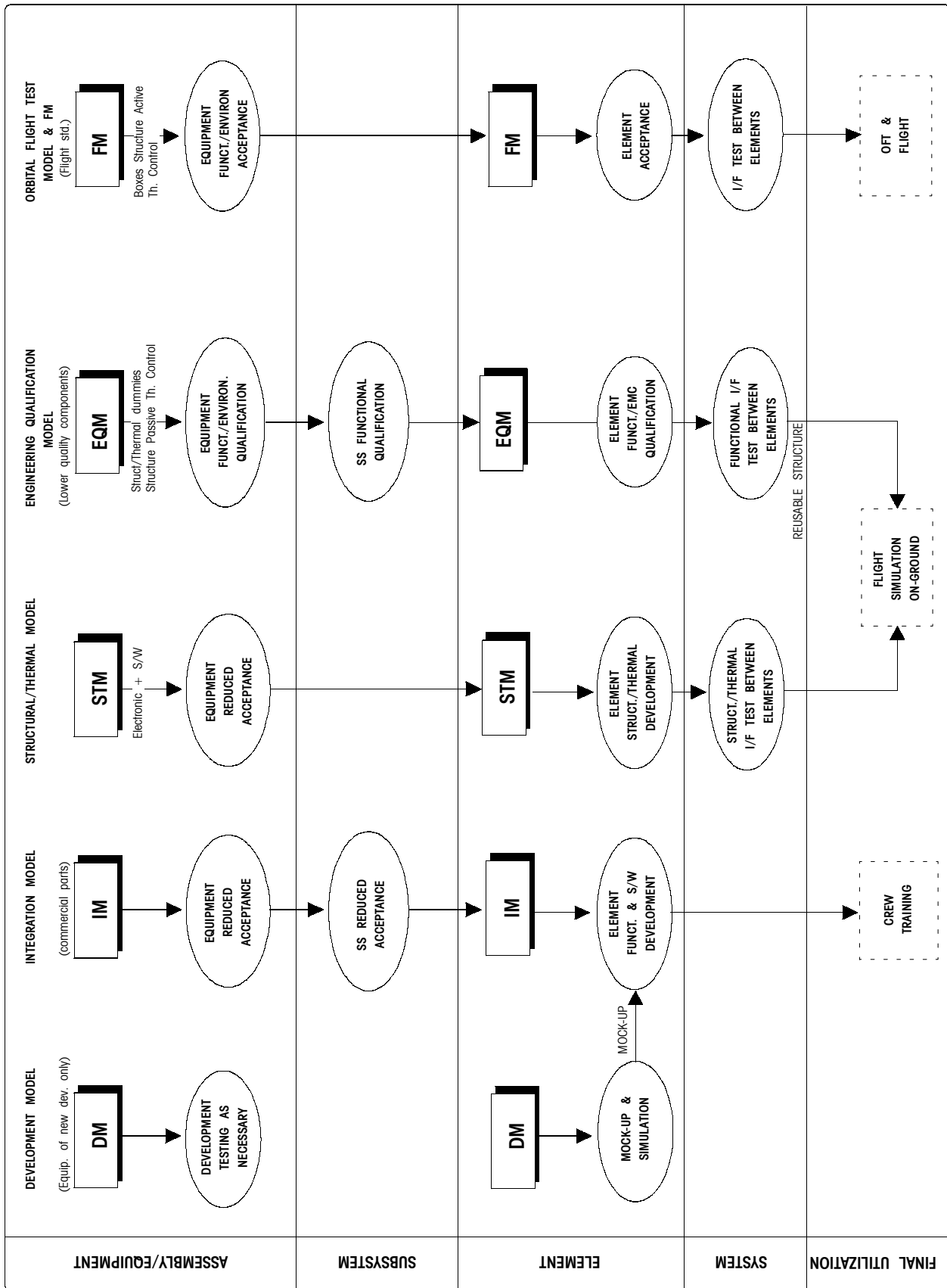

Figure B-2: Manned Project Model philosophy

B.1.2.2 Protoflight philosophy

This approach is applied to projects whose characteristics are:

- no critical technology is employed in the design;
- qualified hardware is extensively used;
- compromise is permitted to reduce cost, accepting a moderate level of risk.

The pure protoflight approach is based on a single model (Protoflight Model: see Table B-1) to be flown after it has been subjected to a protoflight qualification and acceptance test campaign (see ECSS-E-10-03 for details).

The advantage of this approach is its low cost.

The disadvantages are:

- increased risks;
- serial activity flow on the same model;
- contextual qualification and acceptance Activities;
- no integration spares.

In the event of recurring units the following shall be taken into account:

- the recurring unit will be PFM if its design has been significantly modified with respect to the qualified flight item;
- the recurring unit will be FM if no or minor modifications (not requiring delta qualification by test) have been carried out.

Figure B-3 shows an example of protoflight model philosophy for a project having also incorporated subsystem activities into the system responsibility, formally deleting the subsystem verification level.

EQMs are utilized at equipment level for pre-qualification tests only in few cases in which significant design modifications would occur.

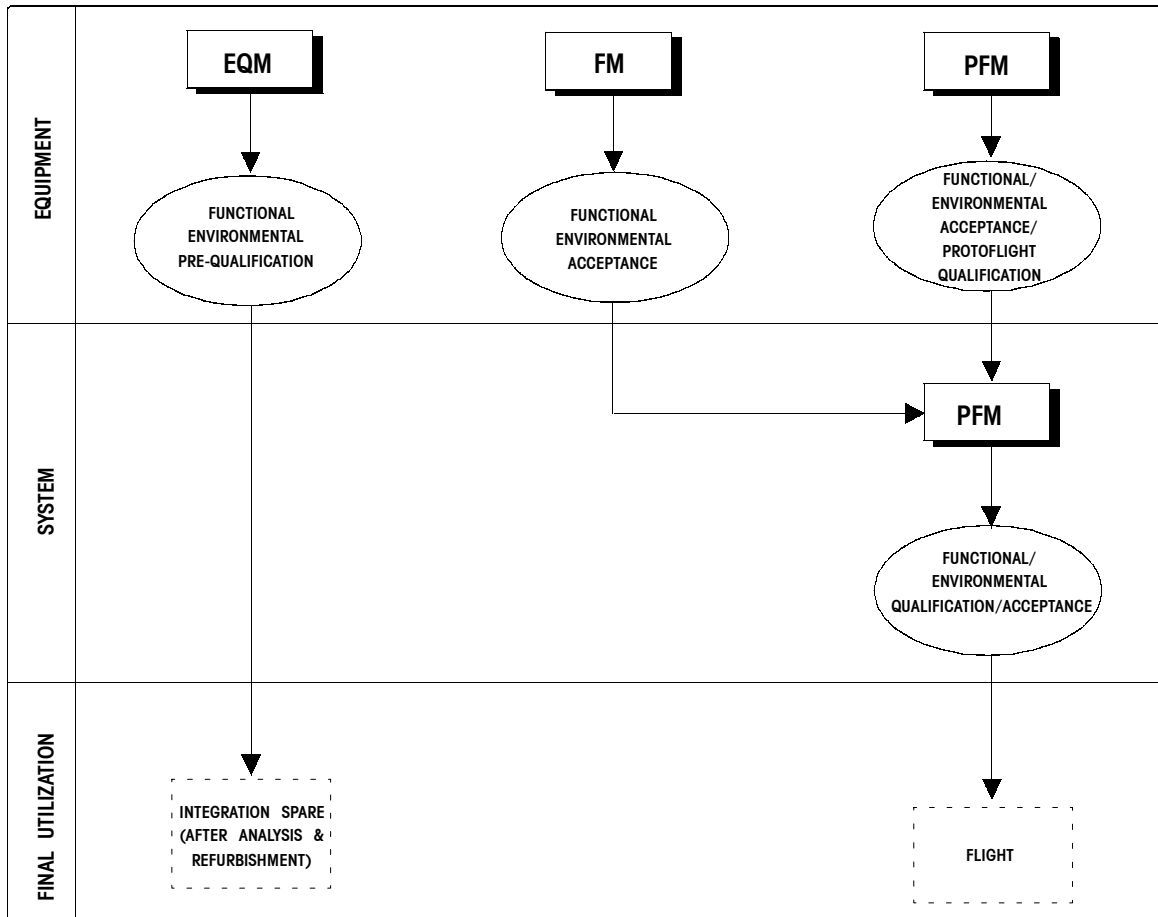

Figure B-3: Protoflight Model philosophy

B.1.2.3 Hybrid philosophy

This philosophy is a compromise between prototype and protoflight approaches. The hybrid model philosophy is used in projects where advanced qualification activities shall be performed in areas of new design or in areas having a critical impact on the verification programme.

The hybrid approach always assumes a protoflight model be flown after a protoflight test campaign whose scope is reduced with respect to that of the pure protoflight approach (see ECSS-E-10-03).

Specific qualification tests in the critical areas are carried out on dedicated models (see Table B-1). In these areas only acceptance testing is performed on the PFM.

The advantages and disadvantages of this approach are intermediate between those of the prototype and the protoflight approaches in terms of risks, costs and schedule.

It represents a good compromise, in fact this is the reason why it is often selected.

In particular in the hybrid approach it is possible to:

- perform some parallel activities;
- use QM and EQM (if foreseen in the model philosophy) as integration spares during high level activities;
- comply with the delivery dates of high reliability components and accommodate possible use of commercial components.

If, in the event of recurring units, the delta qualification cannot be covered by dedicated models, subclause B.1.2.2 is applicable.

Figure B-4 shows an example of hybrid model philosophy for a scientific satellite in which Payload instrument verification levels similar to the spacecraft subsystem verification levels are defined.

It should be noted that:

- the decoupling of the STM activities from the EM activities allows programme flexibility and reduction of schedule risks;
- the protoflight approach for the instruments will advance availability of the Payload EM for the satellite functional qualification test campaign;
- the EQM or PFM is qualified at equipment level, depending on its development status;
- a suitcase model and the software validation facility at satellite level may be used to verify specific interface performance;
- a mock-up structure may be used for the EM configuration.

B.1.3 Hardware matrix

On the basis of the selected model philosophy and of the qualification status of the equipment, a hardware matrix is prepared.

The equipment is typically classified according to the following categories:

Category A: Off-the-shelf equipment requiring no modification which has been subjected to a qualification test programme for space applications at least as severe as that imposed by the actual project specifications. Further qualification testing is not required.

Category B: Off-the-shelf equipment requiring no modifications that have already been tested and qualified but subjected to a different qualification programme or to a different environment. A delta qualification test programme shall be decided and performed case by case.

Category C: Off-the-shelf equipment requiring minor design modifications. A delta or full qualification test programme shall be decided on a case-by-case basis depending on the impact of the required modification.

Category D: Newly designed and developed equipment or existing equipment requiring major re-design. A full qualification test programme shall be imposed.

The type and the extent of the test programmes to be imposed for each category depend also on the project model philosophy. The requirements for the test programme definition are provided in ECSS-E-10-03.

The hardware matrix identifies for each equipment the related qualification status and the required models.

Figure B-5 shows an example of hardware matrix for an earth observation satellite.

Figure B-4: Hybrid Model philosophy

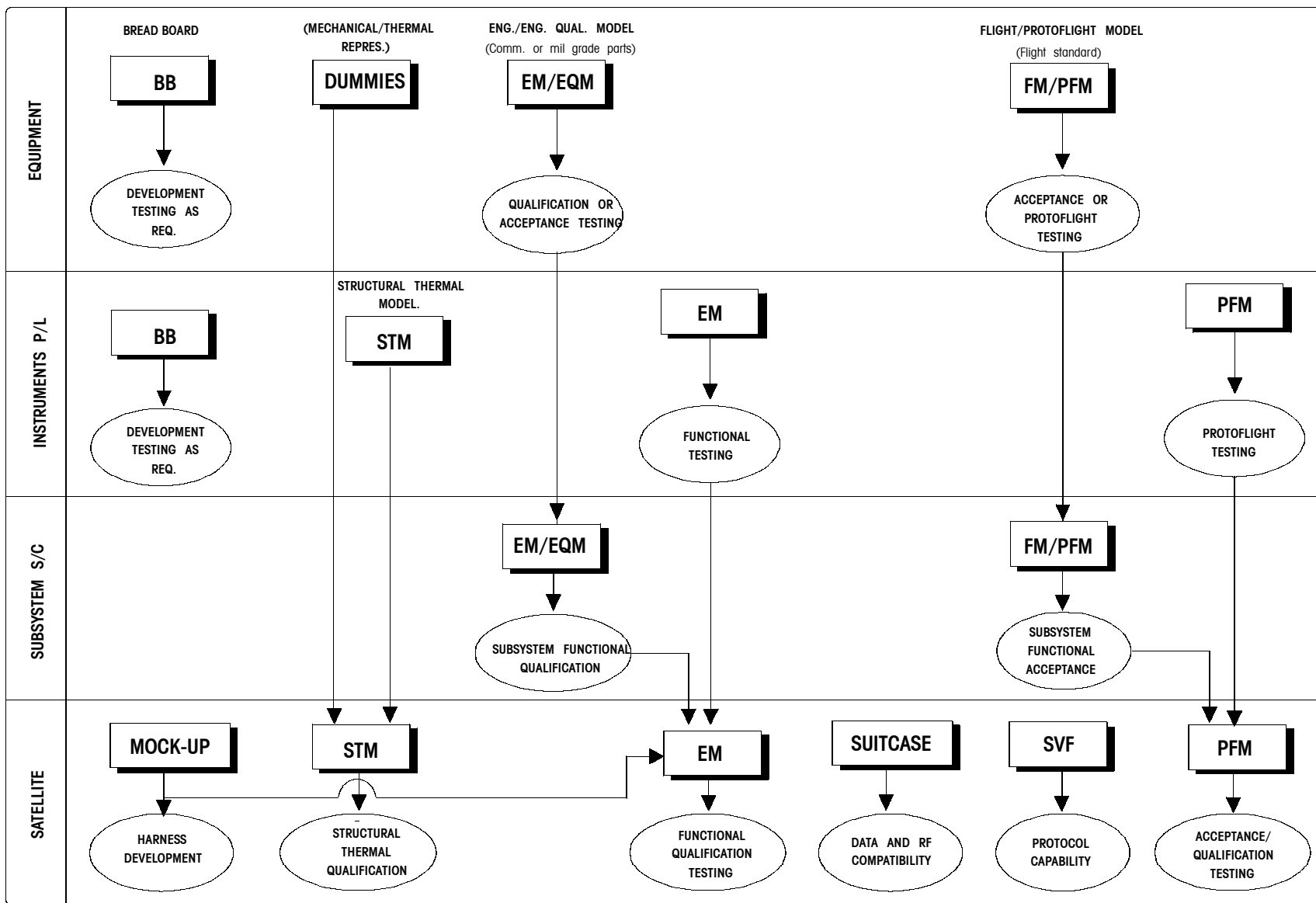

| No. | Subsystem/ Instrument | Abbr. | Qual. Status | DM | STM | EM | FM | SP | Remarks |
|-----|--|---|---|----|-----|--|--|--|--|
| 1 | Structure | STR | D | | 1 | | 1 | * | * STM Spare |
| 2 | Thermal control | TCS | D | | 1 | * | 1 | 1 | * STM Spare |
| 3 | AOCS <ul style="list-style-type: none"> • Coarse Sun Sensor • Star Tracker • Star Tracker Electr. • Gyro package • Gyro Electronic • Reaction wheel • Wheel drive electronic • Actuator gyro electronic • Flap assembly • Attitude control electronic | CSS ST STE GYR GYE RW WDE ADE FL ACE | A A A A A A A A D D | | | 2* 3* 3* 1* 4* 1* 1* 1* 2* 1* | 1 1 1 1 1 1 1 1 1 1 | 2 3 3 1 3 4 1 1 2** 1** | * Dummy * Dummy * Dummy * Dummy * Dummy * Dummy * Dummy * Dummy * Dummy ** PFM * Dummy ** PFM |
| 4 | RCS <ul style="list-style-type: none"> • Tanks • Thrusters • Thrusters bracket • Latch valves • Filter • Flow meter • Fill & drain valves • Valve brackets • Pressure transducers • Pipework | | B(A) A D A A D A D A D | | | 8* 12* 4* 11* 1* 1* 3* 2* 3* 1* | 8** 1 4** 1 1 1 1 2** 1 1** | 8 12 4 11 1 1 3 2 3 1 | * Dummy ** from STM * Dummy * Dummy ** from STM * Dummy * Dummy * Dummy * Dummy * Dummy ** from STM * Dummy * Dummy ** from STM |
| 5 | Power <ul style="list-style-type: none"> • Power control unit • Battery regulator unit • Battery mgn unit • Pyro drive unit • Power distribution unit • Battery | PCU BRU BMU PYR PDU BATT | C A A C D A | 1 | 1 | 1* 1* 1* 1* 1* 2* | 1** 1 1 1** 1 2 | 1 1 1 1 1** 2 | * Dummy ** EQM * Dummy * Dummy * Dummy ** EQM * Dummy ** PFM * Dummy |
| 6 | OBDS <ul style="list-style-type: none"> • Central terminal unit • Common pulsed distr. unit • Digital bus unit • Intelligent control unit • Mass memory unit • Remote bus interface | CTU CPDU DBU ICU MMU RSI | A A A C(D) D(C) A | | | 1* 1* 4* 2* 1* 2* | 1 1 4 2** 1 2 | 1 1 4 2** 1 2 | * Dummy * Dummy * Dummy * Dummy ** EQM * Dummy ** PFM * Dummy |
| 7 | Solar array <ul style="list-style-type: none"> • Deployable panel • Yokes • Mid-panel body | | D D D | | | 2* 1* 3* | 1 1** 1 | 2 2 1 | * Dummy * Dummy ** from STM * Dummy |
| 8 | TT&C <ul style="list-style-type: none"> • Transponder • RF distribution unit • Antenna | | C A D | | | 2* 1* 3* | 1** 1 1 | 2 1 3** | * Dummy * Dummy * Dummy ** 1PFM ** 2EQM |
| 9 | Harness | | D | | | 1 | 1 | 1 | |
| 10 | Radio Instrument | | D | 1 | 1* | 1 | 1** | | * Dummy ** PFM |
| 11 | GPS | | | | 1* | 1 | 1** | | * Dummy ** PFM |
| 12 | Boom | | D | | 1* | 1** | 1 | | * Dummy ** from STM |
| 13 | Magnetometer | | | | 1* | 1 | 1** | | * Dummy ** PFM |

Figure B-5: Typical hardware matrix

B.2 Specific tailoring guidelines

The content of the ECSS-E-10-02 shall be tailored to the specific product (e.g. satellite, manned infrastructure, launcher, Ground Segment, Overall System, Lower level product) and to the applicable project life cycle. In principle the following requirements applicability and tailoring are suggested.

Tailoring includes modification or deletion of the particular requirement. Applicability may be exceptionally deviated by project specific constraints.

| (Sub)clause | Applicable | Tailorable |
|---|------------|------------|
| 4 Verification process | X | |
| 4.1 Verification objectives | | X |
| 4.2 Verification process logic | X | |
| 4.2.1 Verification process flow | X | |
| 4.2.2 Verification approach | X | |
| 4.2.2.1 Verification approach derivation | X | |
| 4.2.3 Verification close-out | X | |
| 4.2.3.1 Verification close-out exceptions | X | |
| 4.3 Verification methods | X | |
| 4.3.1 Test (T) | X | |
| 4.3.1.1 Test principles and procedures | X | |
| 4.3.1.2 Test evaluation | X | |
| 4.3.1.3 Demonstration | X | |
| 4.3.2 Analysis (A) | X | |
| 4.3.2.1 Analytical techniques | X | |
| 4.3.2.2 Similarity | X | |
| 4.3.3 Review-of-design (R) | X | |
| 4.3.4 Inspection (I) | X | |
| 4.4 Verification levels | | X |
| 4.5 Verification stages (Equipment, Subsystem, Element, System) | | X |
| 4.5.1 Qualification | X | |
| 4.5.1.1 Qualification article | | X |
| 4.5.1.2 Re-qualification | | X |
| 4.5.2 Acceptance | X | |
| 4.5.2.1 Acceptance article | X | |
| 4.5.2.2 Re-certification | | X |
| 4.5.3 Pre-launch | | X |
| 4.5.4 In-orbit | | X |
| 4.5.4.1 In-orbit re-verification | | X |
| 4.5.5 Post-landing | | X |
| 5 Verification strategy | X | |
| 5.1 Requirements classification | | X |
| 5.1.1 Requirements documentation | | X |
| 5.1.2 Requirement characteristics | X | |
| 5.1.3 Requirement criticality | X | |
| 5.1.4 Requirements not to be tracked | X | |
| 5.1.5 Requirements categories | | X |
| 5.1.6 Requirements traceability | X | |
| 5.1.7 Verification matrix | X | |

| (Sub)clause | Applicable | Tailorable |
|--|-------------------|-------------------|
| 5.2 Selection of methods, levels and stages of verification | X | |
| 5.2.1 Selection of verification method | X | |
| 5.2.2 Selection of verification level | X | |
| 5.2.3 Selection of verification stages | X | |
| 5.2.4 Additional rules for selection | | X |
| 5.3 Selection of models | | X |
| 5.3.1 Model philosophy definition | | X |
| 5.3.2 Model applicability | | X |
| 5.4 Verification by test | X | |
| 5.4.1 Test programme definition | X | |
| 5.4.2 Integration flow | X | |
| 5.4.3 Integration tests | X | |
| 5.4.4 Re-integration tests | | X |
| 5.4.5 Test versus verification stages | | X |
| 5.4.6 Test versus verification levels | | X |
| 5.4.7 Test matrices | | X |
| 5.5 Verification by analysis | X | |
| 5.5.1 Analysis programme definition | X | |
| 5.5.2 Verification analysis criteria | X | |
| 5.5.2.1 Similarity criteria | X | |
| 5.5.3 Analysis versus verification stages | X | |
| 5.5.4 Analysis versus verification levels | X | |
| 5.5.5 Analysis matrices | | X |
| 5.6 Verification by Review-of-design | X | |
| 5.6.1 Review-of-design programme definition | X | |
| 5.6.2 Review-of-design versus verification stages | X | |
| 5.6.3 Review-of-design versus verification levels | X | |
| 5.6.4 Review-of-design matrices | | X |
| 5.7 Verification by inspection | X | |
| 5.7.1 Inspection programme definition | X | |
| 5.7.2 Inspection versus verification stages | X | |
| 5.7.3 Inspection versus verification levels | X | |
| 5.7.4 Inspection matrices | | X |
| 5.8 Re-flight verification | | X |
| 5.8.1 Re-flight verification programme | | X |
| 5.8.2 Re-flight verification activities | | X |
| 6 Verification implementation | X | |
| 6.1 Verification responsibilities | | X |
| 6.1.1 Verification Control Board (VCB) | X | |
| 6.1.2 Test Readiness Review (TRR) and Post Test Review (PTR) | X | |
| 6.1.3 Nonconformance Review Board (NRB) | X | |
| 6.1.4 Verification responsibilities documentation | X | |
| 6.2 Verification planning | | X |
| 6.2.1 Verification planning content | | X |
| 6.2.2 Phasing with project life cycle | | X |
| 6.2.3 Verification planning documentation | | X |

| (Sub)clause | Applicable | Tailorable |
|--|------------|------------|
| 6.3 Verification tools | X | |
| 6.3.1 Tools validation | X | |
| 6.3.2 Ground Support Equipment (GSE) | X | |
| 6.3.2.1 GSE validation | X | |
| 6.3.2.2 GSE test program | X | |
| 6.3.2.3 Modified or redesigned GSE | X | |
| 6.3.3 Software Validation Facility (SVF) | | X |
| 6.3.3.1 SVF validation | | X |
| 6.3.4 Simulators | X | |
| 6.3.4.1 Simulators validation | X | |
| 6.3.5 Software tools for verification by analysis | X | |
| 6.3.5.1 Analytical software tools validation | X | |
| 6.3.6 Integration and test facilities and equipment | X | |
| 6.3.6.1 Integration and test facilities and equipment validation | X | |
| 6.4 Verification execution and control | X | |
| 6.4.1 Verification Data Base | X | |
| 6.4.2 Re-verification | X | |
| 6.4.3 Verification execution evidence | X | |
| 6.4.4 Verification close-out | X | |
| 6.4.5 Test effectiveness | | X |
| 6.4.6 Verification lessons learnt | | X |
| 6.5 Verification documentation | | X |
| 6.5.1 Verification documents | X | |
| 6.5.1.1 Verification matrix | X | |
| 6.5.1.2 Test requirement specification | | X |
| 6.5.1.3 AIV plan | X | |
| 6.5.1.4. Verification Control Document (VCD) | X | |
| 6.5.1.5 Test specification | | X |
| 6.5.1.6 Test procedure | X | |
| 6.5.1.7 Test report | X | |
| 6.5.1.8 Analysis report | X | |
| 6.5.1.9 Review-of-design report | X | |
| 6.5.1.10 Inspection report | X | |
| 6.5.1.11 Verification report | | X |
| 6.5.2 Other documents | | X |

B.3 Re-verification review guidelines for re-flight

The following reminders are intended to be used as a check-list to create re-verification requirements for re-flight.

Mechanical system

- inspection for structural integrity/completeness (still in configuration?);
- inspection for damage, wearout, abrasion, vacuum welding, surface finish;
- inspection for any corrosion or other material incompatibility effects;
- verification of all joints and securing devices;
- verification after de-integration and assembly;
- fit check with new flight ampoules, samples and other new dedicated items;

- dry or wet greasing inspection;
- test of mechanical overload protections;
- check of torque moments, self-locking moments, helicoil inserts and fasteners.

Structural system

- verification of interface loads, fatigue, fracture control;
- inspection/test for stress corrosion defects;
- inspection for any kind of corrosion.

Cooling system

- inspection of cooling lines for corrosion, deformation, cracks and cleanliness;
- inspection and test of all connections and valves;
- pressure proof and leak test;
- check of sealing and replace as necessary.

Pressure system

- check of sealing and replace as necessary;
- pressure proof and leak test;
- inspection and test of pressure components as regulators and valves;
- in addition for pressure vessels: Verification of fracture mechanics, fatigue analysis, stress-corrosion.

Vacuum system

- check of sealing and replace as necessary;
- vacuum quality test;
- leakage test;
- functional test.

Electrical systems

- bonding tests for all removed/re-installed or replaced units/items;
- replacement of fuses;
- verification of all electrical functions, parameters, limits, interfaces, calibration curves of sensors;
- verification of redundancy;
- verification of all electrical connections (Harness integrity, abrasion, connector inspection, connector mating cycles);
- EMC requirements and tests or assessment.

Software

- configuration control and verification of possible changes with and to flight hardware;
- verification of complete final software with flight hardware by test.

Safety/Dependability

- review of hazard controls;
- simulation of “redline limits” to verify existence of proper hazard controls;
- training of safety critical procedures;
- review of verification method and close-out (all hazard reports and verification tracking log) considering also the impact of all changes/modifications;
- verification of redundancy.

Environmental

- centre of gravity (on product level);
- mass determination (on product level);
- vibration (only on a very selected basis for refurbished sensitive items);

- temperature cycling (only on a very selected basis for refurbished sensitive items);
- leak testing;
- vacuum/pressure proof testing;
- offgassing test in case refurbished items are not identical in material and if material is unknown or if test data are not available;
- re-verification of micro-g-requirements.

Life limited items

- replacement where necessary for life and cycle limited items as well as wear and tear. This includes the verification of conformance to material and safety requirements if other material will be used;
- inspection intervals;
- worn parts and materials;
- EEE-parts.

Designation

- new designation/labelling.

Cleaning

- cleaning to be performed based on approved cleaning procedures and approved cleaning agents.

NOTE The above reminders represent a rough check-list only. Further items might be valid due to uniqueness of individual missions and/or products.

B.4 Verification activities guidelines

This subclause elaborates on the requirements of the verification process activities given in subclause 6.2 for a typical space programme, and the definitions of phases and events of ECSS-M-30.

B.4.1 Phase A

During the *Feasibility Phase (Phase A)* the verification activities are focused on the assessment of the general project requirements and on the definition of the development and verification approach, including the Model Philosophy and the associated Hardware Matrix.

The results are discussed at the *Preliminary Requirement Review (PRR)* in order to assess the feasibility of the development and verification programme.

B.4.2 Phase B

During the *Preliminary Definition Phase (Phase B)* in parallel with the system definition and design, particular effort is spent in supporting the requirements generation and allocation in order to have a consistent set of verifiable and traceable requirements at all levels.

This work includes the preparation of verification matrices which form the basis of subsequent verification planning and control.

In particular, the environmental requirements will be used as an input to generate the project Test Requirement Specification applicable to the different verification levels.

The applicable requirements are grouped in categories and, for each major category, a verification strategy is generated on the basis of the detailed verification methods, levels and stages, and the coherence of the overall verification approach is checked.

These strategies allow the identification of the verification tasks (in terms of objectives, characteristics, success criteria and supporting tools), which form the core of the Assembly Integration and Verification Plan.

The same strategies are inputs for Lower Level planning.

The verification approach is also included as fundamental part of the overall Design and Development Plan.

Usually, in Phase B, also lower level activities are initiated. In particular some C/D development tests are anticipated for critical items.

In addition, the preparation of the Verification Control Documents at the different levels is recommended in order to arrive to a more reliable phase C/D programmatic assessment.

The output of Phase B, in particular verification requirements and planning, are discussed at the *System Requirement Review (SRR)* and at the *Preliminary Design Review (PDR)* in order to freeze system design and implementation concepts.

B.4.3 Phase C

With the start of the *Detailed Definition Phase (Phase C)* the detailed design is initiated, so particular attention shall be paid to accessibility, testability, handling and transport in order that integration can be performed in the most effective way and that the GSE design can be optimized.

In this phase, development tests are carried out. Preliminary verification by analysis and Review-of-Design are executed at lower levels and the results discussed at the relevant *Preliminary Design Review (PDR)*.

During the same phase the equipment manufacturing will be started on the basis of the frozen design.

Verification by inspection activities start during the lower level manufacturing process.

The activities related to the procurement of the foreseen verification tools are also initiated and their availability assured for the relevant activities.

The integration activities on the system models (e.g. STM and EM) start in accordance with the relevant integration and test specifications and procedures.

The system monitoring and control of lower level verification activities is continued in parallel and results are fed to the verification data base.

The Phase C is normally terminated with the *Critical Design Review (CDR)* where analysis and Review-of-Design activities are completed and qualification tests are terminated at lower levels and initiated at higher level.

Usually the CDR authorizes the flight unit manufacturing (i.e. the start of the next phase).

B.4.4 Phase D

The *Production Phase (Phase D)* is completing the qualification and acceptance activities from the lowest to the highest levels.

In particular integration and test are carried out and controlled through the relevant reviews and the corresponding verification reports are prepared as required.

The verification close-out is documented through the Verification Control Documents, frozen by the Verification Control Boards.

They are presented at the *Qualification Review (QR)* and *Acceptance Review (AR)* which declare the completion respectively of the qualification and acceptance activities also in view of possible multi-mission (in this respect a multi-mission qualification review is sometime separately identified).

B.4.5 Phase E

The *Utilization Phase (Phase E)* includes launch campaign and in-orbit testing, the evaluation of the verification results and the readiness for the next phase are the objectives respectively of the *Launch Readiness Review (LRR)* and of *Commissioning Review (CR)*.

B.4.6 Phase F

In case of a *Disposal phase (Phase F)* the re-entry activities are authorized with an *End Of Life (EOL)* review and the recovery and post landing verification are evaluated during a dedicated review.

B.4.7 Verification flow

A detailed flow of the mentioned verification activities is shown in Figures B-6 and B-7.

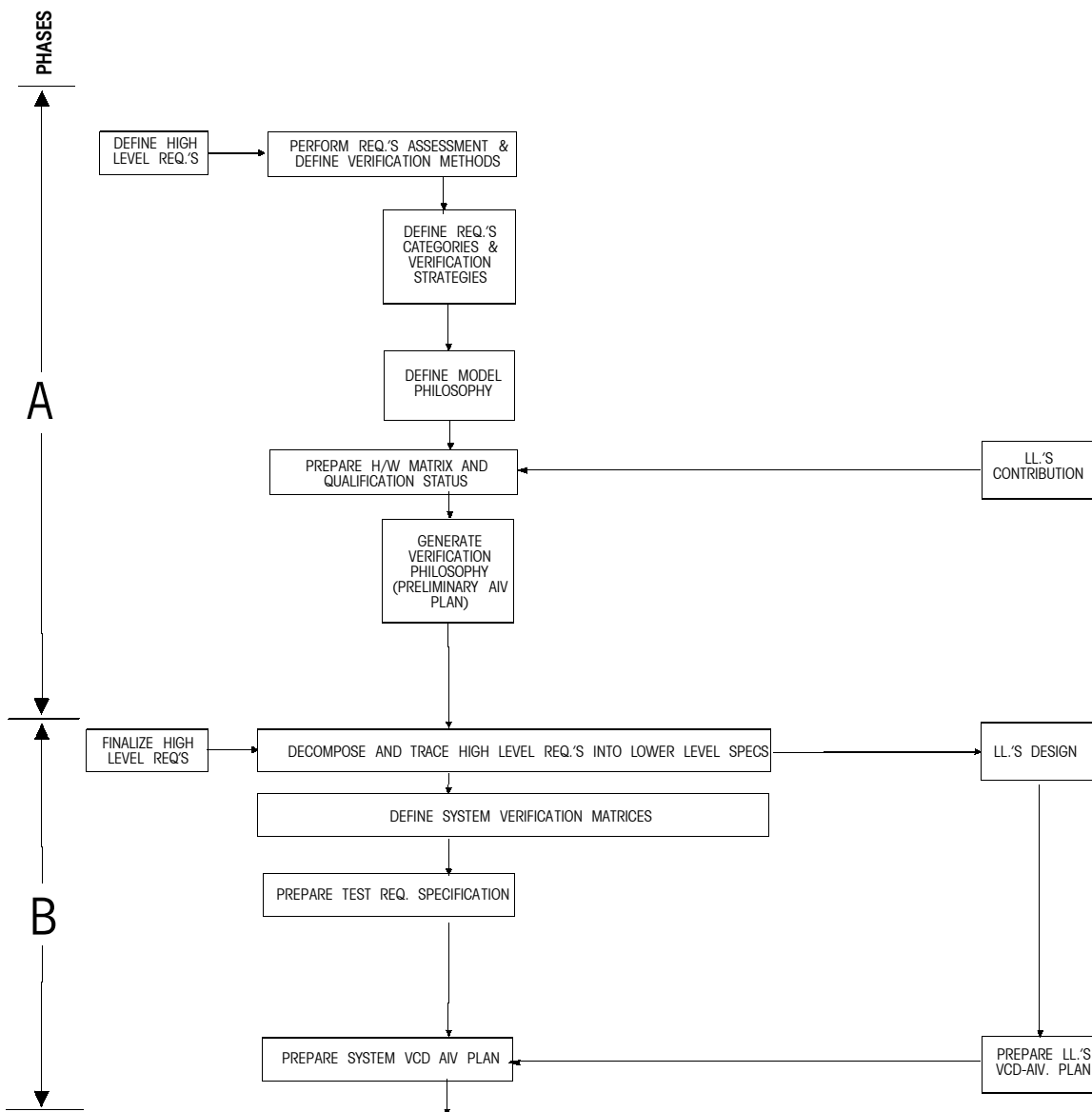

Figure B-6: Verification activities flow (Phases A and B)

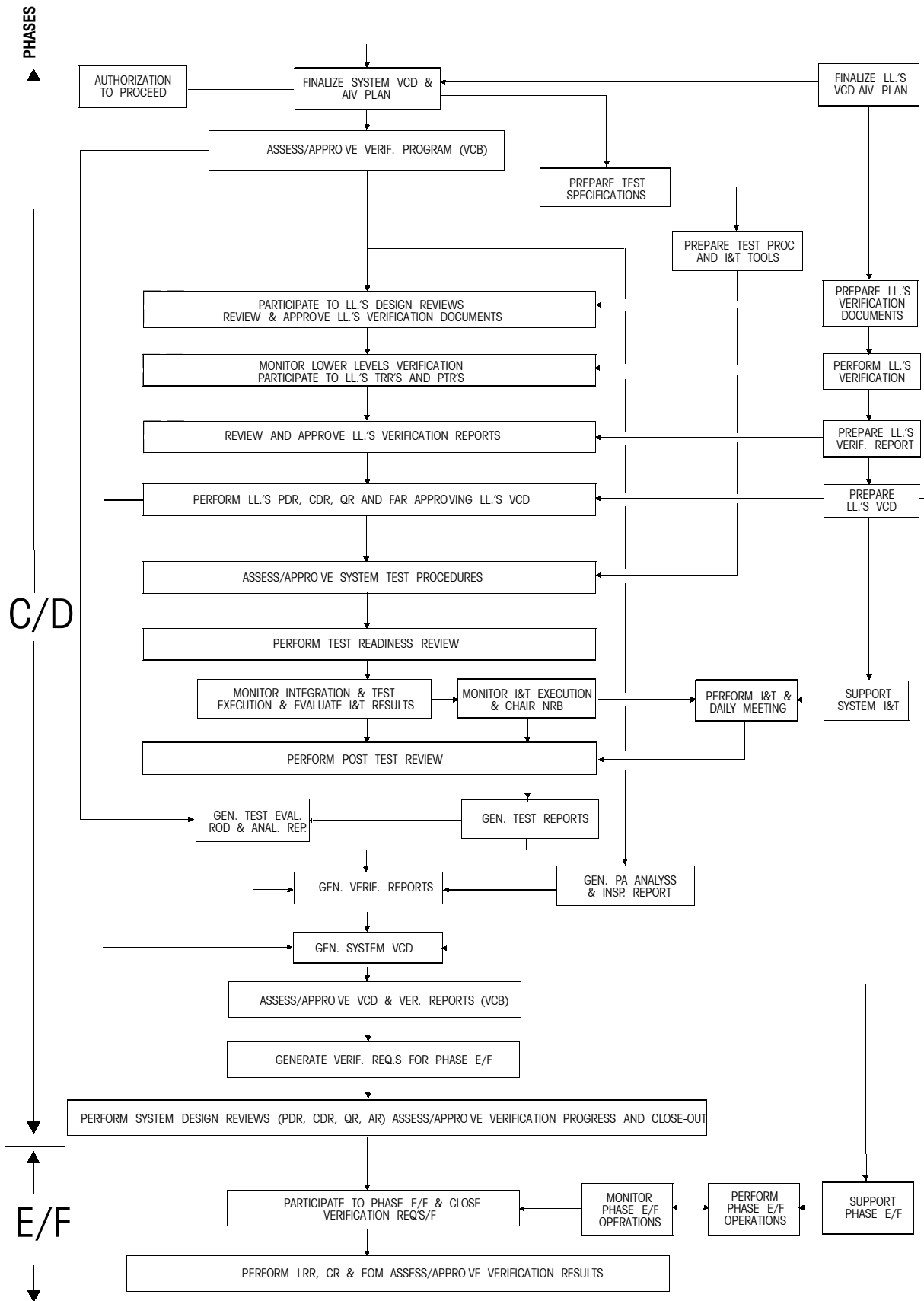

Figure B-7: Verification activities flow (Phases C/D and E/F)

B.5 Typical verification team responsibility

Having regard to the activities and documentation defined in the clause 6, the verification team shall be typically responsible for:

- verification management and interfaces with the customer for verification aspects;
- contribution to Project Design Reviews;
- requirement allocation and traceability support;
- verification matrix definition;
- verification philosophy and AIV plan preparation;
- CD preparation and verification data base management;
- providing the chairman of Verification Control Board;
- monitoring of lower level verification documentation;
- participation in lower design and test reviews;
- review and approval of lower verification documentation;
- test specifications/procedures preparation;
- review-of-design/analysis/inspection procedures preparation;
- providing of integration and test facilities;
- procurement and maintenance of GSE, STE and test aids;
- providing the chairman of Test Review Boards;
- performing of integration and test execution and participation in Nonconformance Review Board (NRB);
- preparation of test and verification reports;
- generation of verification requirements for phase E/F;
- performing of verification activities during phase E/F.

B.5.1 Relationship with engineering

Coordination and coherence of the contribution of specific engineering disciplines to the verification process shall be assured by the verification team. In particular the following areas of cooperation are typically envisaged:

- requirement decomposition in measurable parameters;
- support to verification matrix definition;
- support to Verification Control Board;
- support to test specifications preparation;
- participation in lower level verification monitoring;
- review and approval of test procedures;
- participation to test reviews;
- monitor system integration and test execution in order to evaluate test results;
- execution of analysis/review-of-design and preparation of the relevant reports;
- support to phase E/F verification requirements generation.

B.5.2 Relationship with product assurance & quality control

The verification team shall work in cooperation with the product assurance and quality control team, in particular the following areas of cooperation are typically envisaged:

- support to Verification Matrix definition;
- participation in lower level verification monitoring;
- participation in test reviews;
- monitoring of integration and test execution and chairing of NRB;
- execution of analysis/inspection and preparation of the relevant reports;
- monitoring of Phase E/F operations.

B.5.3 Relationship with project management

The verification team shall work in cooperation with the project management team, in particular the following areas of cooperation are typically envisaged:

- support to verification planning and model philosophy;
- support to monitoring and control of resources and schedule;
- support to management of changes;
- preparation of test configuration list;
- participation in lower level verification monitoring;
- participation in test reviews.

(This page is intentionally left blank)

Annex C (normative)

Verification matrix - Document Requirements Definition (DRD)

C.1 Introduction

As required by ECSS-E-10-02, this matrix defines for each requirement the corresponding verification method at the applicable verification level in the relevant verification stage. It may be included in the “Product specification”.

The verification matrix is the starting point for the VCD and will be eventually incorporated in the VCD as soon as it is frozen.

C.2 Scope and applicability

C.2.1 Scope

This Document Requirements Definition (DRD) establishes the data content requirements for the Verification matrix.

This DRD does not define format, presentation or delivery requirements for the Verification matrix.

C.2.2 Applicability

This DRD is applicable to all projects using the ECSS Standards.

C.3 References

C.3.1 Glossary and dictionary

This DRD uses terminology and definitions controlled by:

| | |
|--------------|----------------------------------|
| ECSS-P-001 | Glossary of terms |
| ECSS-E-10-02 | Space engineering - Verification |

C.3.2 Source document

This DRD defines the data requirements of a verification matrix as controlled by:

| | |
|--------------|----------------------------------|
| ECSS-E-10-02 | Space engineering - Verification |
|--------------|----------------------------------|

C.4 Definitions, abbreviations and symbols

C.4.1 Definitions

For the purposes of this DRD the definitions given in ECSS-P-001 and in ECSS-E-10-02 apply.

C.4.2 Abbreviations

The following abbreviations are defined and used within this DRD.

| Abbreviation | Meaning |
|---------------------|--|
| A | Analysis |
| ACC | Acceptance |
| AIV | Assembly, Integration and Verification |
| AOCS | Attitude and Orbit Control System |
| DRD | Document Requirements Definition |
| ECSS | European Cooperation for Space Standardization |
| EL | Element |
| EQ | Equipment |
| I | Inspection |
| N/A | Not applicable |
| QUAL | Qualification |
| R | Review of Design |
| REQ | Requirement |
| RTU | Remote Terminal Unit |
| SRD | System Requirement Document |
| SS | Subsystem |
| SY | System |
| T | Test |
| VCD | Verification Control Document |

C.4.3 Symbols

N/A

C.5 Description and purpose

The verification matrix defines the verification strategy for each product requirement in terms of methods/levels/stages. It is used by the customer in association with the applicable requirement to define the required verification; when discussed and mutually agreed it represents the verification implementation approach proposed by the supplier.

C.6 Application and interrelationship

A matrix is prepared for each product specification at the chosen verification levels and may be incorporated in the relevant product specification.

In this case the content of the document could be simplified (e.g. subclauses from C.7.1 to C.8.3.2 could be combined with the corresponding clauses of the product specification).

It is input to the preparation of the AIV plan (DRD annex D) and of the VCD (DRD annex E) into which it is incorporated as soon as frozen.

C.7 Verification matrix preliminary elements

C.7.1 Title

The document to be created based on this DRD shall be titled “[insert a descriptive modifier] verification matrix”.

The descriptive modifier shall be selected to clearly identify the applicable product and level specification.

EXAMPLE “RTU equipment specification verification matrix”
“AOCS subsystem specification verification matrix”
“System specification verification matrix”

C.7.2 Title page

The title page shall identify the project document identification number, title of the document, date of release and release authority.

C.7.3 Contents list

The contents list shall identify the title and location of every clause and major subclause, figure, table and annex contained in the document.

C.7.4 Foreword

A foreword shall be included which describes as many of the following items as are appropriate:

- identification of which organizational entity prepared the document;
- information regarding the approval of the document;
- identification of other organizations that contributed to the preparation of the document;
- a statement of effectivity identifying which other documents are cancelled and replaced in whole or in part;
- a statement of significant technical differences between this document and any previous document;
- the relationship of the document to other standards or documents.

C.7.5 Introduction

An introduction may be included to provide specific information or commentary about the technical content.

C.8 Content

C.8.1 Scope and applicability

This clause shall be numbered 1 and shall describe the scope, applicability and purpose of the verification matrix.

C.8.1.1 Scope

This subclause shall be numbered 1.1 and shall contain the following statements:

“This verification matrix defines the verification strategy for the [insert product and level specification identifier] requirements of the [insert project identifier] project.”

C.8.1.2 Purpose

This subclause shall be numbered 1.2 and shall contain the following statements:

“This verification matrix is used by the applicable requirement contractual authority to define the required verification; it will be reviewed and commented by the involved parties. After a mutual agreement it will become the starting point for the relevant VCD.”

C.8.2 References

This clause shall be numbered 2 and shall contain the following subclauses.

C.8.2.1 Normative references

This subclause shall be numbered 2.1 and shall contain the following statements:

“This document incorporates, by dated or undated reference, provisions from other publications. These normative references are cited at appropriate places in the text and publications are listed hereafter. For dated references, subsequent amendments to or revisions of any of these apply to this document only when incorporated in it by amendment or revision. For undated references, the latest edition of the publication referred to applies.

[insert document identifier] [insert document title].”

Typically the reference document is the associated product specification.

C.8.2.2 Informative references

This subclause shall be numbered 2.2 and shall contain the following statement:

“The following documents, although not a part of this verification matrix, amplify or clarify its contents:

[insert document identifier] [insert document title].”

C.8.3 Definitions and abbreviations

This clause shall be numbered 3 and shall contain the following subclauses.

C.8.3.1 Definitions

This subclause shall be numbered 3.1 and shall list any applicable project dictionary or glossary, and all unusual terms or terms with a meaning specific to the verification matrix, with the definition for each term.

If a project dictionary or glossary is applicable, insert the following sentence:

“The definitions of [insert title and identifier of applicable dictionaries or glossaries] apply to this document.”

Insert the following sentence:

“The following terms and definitions are specific to this document: [insert term] [insert definition].”

C.8.3.2 Abbreviations

This subclause shall be numbered 3.2 and shall list all abbreviations used in the verification matrix with the full spelled-out meaning or phrase for each abbreviation.

C.8.4 Verification entries

This clause shall be numbered 4 and shall list, in relationship to each requirement the selected verification method(s), at the proper verification level(s), in the relevant verification stage(s).

(This page is intentionally left blank)

Annex D (normative)

Assembly, Integration and Verification (AIV) plan - Document Requirements Definition (DRD)

D.1 Introduction

As required by ECSS-E-10-02, this document is the master plan for the project verification process and demonstrates how the requirements will be verified by a coherent implementation approach. This plan includes the assembly, integration and test planning.

In specific circumstances (e.g. project with a complex production cycle) the assembly and integration plan may be a separate document.

For certain lower level product (e.g. simple equipment) the AIV plan could be reduced to the test plan.

D.2 Scope and applicability

D.2.1 Scope

This Document Requirements Definition (DRD) establishes the data content requirements for the AIV plan.

This DRD does not define format, presentation or delivery requirements for the AIV plan.

D.2.2 Applicability

This DRD is applicable to all projects using the ECSS Standards.

D.3 References

D.3.1 Glossary and dictionary

This DRD uses terminology and definitions controlled by:

| | |
|--------------|----------------------------------|
| ECSS-P-001 | Glossary of terms |
| ECSS-E-10-02 | Space engineering - Verification |

D.3.2 Source document

This DRD defines the data requirements of an AIV plan as controlled by:

| | |
|--------------|----------------------------------|
| ECSS-E-10-02 | Space engineering - Verification |
|--------------|----------------------------------|

D.4 Definitions, abbreviations and symbols

D.4.1 Definitions

For the purposes of this DRD the definitions given in ECSS-P-001 and in ECSS-E-10-02 apply.

D.4.2 Abbreviations

The following abbreviations are defined and used within this DRD.

| Abbreviation | Meaning |
|---------------------|--|
| AFE | Airborne Flight Equipment |
| AIT | Assembly, Integration and Test |
| AIV | Assembly, Integration and Verification |
| AOCS | Attitude Orbital Control Subsystem |
| BB | Bread Board |
| CDR | Critical Design Review |
| DM | Development Model |
| D.M. | Data Management |
| DRD | Document Requirements Definition |
| ECLS | Environmental Control and Life Support |
| ECSS | European Cooperation for Space Standardization |
| EL | Element |
| EM | Electrical Model |
| EMC | Electromagnetic Compatibility |
| EQ | Equipment |
| EQM | Electrical Qualification Model |
| ESD | Electrostatic Discharge |
| EXT | External |
| FAR | Flight Acceptance Review |
| FM | Flight Model |
| FV | Flight Vehicle |
| GNC | Guidance Navigation and Control |
| GPS | Global Positioning System |
| GSE | Ground Support Equipment |
| H/W | Hardware |
| I/F | Interface |
| IM | Integration Model |
| INT | Internal |
| LRR | Launch Readiness Review |
| N/A | Not applicable |
| OBDH | On-Board Data Handling |
| OFT | Optical Flight Test |
| OP's | Operations |
| P/L | Payload |
| PFM | Protoflight Model |
| QR | Qualification Review |

| | |
|-----------------|---------------------------------|
| RCS | Reaction Control Subsystem |
| RF | Radio Frequency |
| S/C | Spacecraft |
| SS | Subsystem |
| S/W | Software |
| SP | Space Model |
| SRR | System Requirement Review |
| STM | Structural Thermal Model |
| SVF | Software Validation Facility |
| SY | System |
| TT&C | Telemetry, Tracking and Command |

D.4.3 Symbols

N/A

D.5 Description and purpose

The AIV plan describes the product supplier's AIV programme.

It contains the overall verification approach, the model philosophy, the hardware matrix, the verification strategies for each requirement category, the analysis/review of design/inspection programme, the assembly integration and test programme, the AIV activity sheets and the relevant planning, the selected test facilities, the verification tools, the verification control methodology, the involved documentation, the verification management and organization.

Its principal use is to provide the customer a basis for review and evaluation of the effectiveness of the AIV programme and its proposed elements.

When prepared at higher product level it is also used as input to the "system engineering plan" for the design and development aspects and as input to the lower level verification.

It may be combined with the "system engineering plan" typically for small projects or lower level products.

D.6 Application and interrelationship

An AIV Plan is prepared for the different verification levels covering in detail the verification activity at that level and outlining the lower level aspects.

Lower level philosophy is coherent with the overall verification approach.

It is originated on the basis of the applicable specifications and associated verification matrices (DRD annex C), taking into account the development philosophy, the general test standards defined in the test requirement specification, programmatic constraints and availability of tools and facilities.

It originates test specifications (DRD annex F) and test procedures (DRD annex G).

It refers to the content of ECSS-E-10-02.

D.7 AIV plan preliminary elements

D.7.1 Title

The document to be created based on this DRD shall be titled "[insert a descriptive modifier] AIV plan".

The descriptive modifier shall be selected to clearly identify the applicable product and level.

EXAMPLE “ECLS subsystem AIV plan”
“Cargo carrier element AIV plan”

D.7.2 Title Page

The title page for this document shall identify the project document identification number, title of the document, date of release and release authority.

D.7.3 Contents List

The contents list shall identify the title and location of every clause and major subclause, figure, table and annex contained in the document.

D.7.4 Foreword

A foreword shall be included which describes as many of the following items as are appropriate:

- identification of which organizational entity prepared the document;
- information regarding the approval of the document;
- identification of other organizations that contributed to the preparation of the document;
- a statement of effectivity identifying which other documents are cancelled and replaced in whole or in part;
- a statement of significant technical differences between this document and any previous document;
- the relationship of the document to other standards or documents.

D.7.5 Introduction

An introduction may be included to provide specific information or commentary about the technical content.

D.8 Content

D.8.1 Scope and applicability

This clause shall be numbered 1 and shall describe the scope, applicability and purpose of the AIV plan.

D.8.1.1 Scope

This subclause shall be numbered 1.1 and shall contain the following statements:

“This AIV plan defines the AIV programme for the [insert product and level identifier] of the [insert project identifier] project.

This AIV plan is based on the [insert requirements specification identifier] requirements and associated verification matrix (if any).”

D.8.1.2 Purpose

This subclause shall be numbered 1.2 and shall contain the following statements:

“This AIV plan provides a basis for review and evaluation of the effectiveness of the AIV programme and its proposed elements. In addition (if applicable) it is an input to the “system engineering plan” for the design and development aspects and an input to the lower level verification.”

D.8.2 References

This clause shall be numbered 2 and shall contain the following subclauses.

D.8.2.1 Normative references

This subclause shall be numbered 2.1 and shall contain the following statements:

“This document incorporates, by dated or undated reference, provisions from other publications. These normative references are cited at appropriate places in the text and publications are listed hereafter. For dated references, subsequent amendments to or revisions of any of these apply to this document only when incorporated in it by amendment or revision. For undated references, the latest edition of the publication referred to applies.

[insert document identifier] [insert document title].”

Typically the reference documents are the product specification, the associated verification matrix and the relevant statement of work.

D.8.2.2 Informative references

This subclause shall be numbered 2.2 and shall contain the following statement:

“The following documents, although not a part of this AIV plan, amplify or clarify its contents:

[insert document identifier] [insert document title].”

D.8.3 Definitions and abbreviations

This clause shall be numbered 3 and shall contain the following subclauses.

D.8.3.1 Definitions

This subclause shall be numbered 3.1 and shall list any applicable project dictionary or glossary, and all unusual terms or terms with a meaning specific to the AIV plan, with the definition for each term.

If a project dictionary or glossary is applicable, insert the following sentence:

“The definitions of [insert title and identifier of applicable dictionaries or glossaries] apply to this document.”

Insert the following sentence:

“The following terms and definitions are specific to this document:

[insert term] [insert definition].”

D.8.3.2 Abbreviations

This subclause shall be numbered 3.2 and shall list all abbreviations used in the AIV plan with the full spelled-out meaning or phrase for each abbreviation.

D.8.4 Verification subject

This clause shall be numbered 4 and shall describe the subject of the verification process.

D.8.5 Verification approach

This clause shall be numbered 5 and shall describe the basic verification concepts and definitions as a tailoring of ECSS-E-10-02 (methods/levels/stages).

D.8.6 Model philosophy

This clause shall be numbered 6 and shall describe the selected models, the associated model philosophy and hardware matrix. (see ECSS-E-10-02 annex B.1).

They may be summarized in dedicated format tables (see Figures D-1, and D-2 and Tables D-1 and D-2).

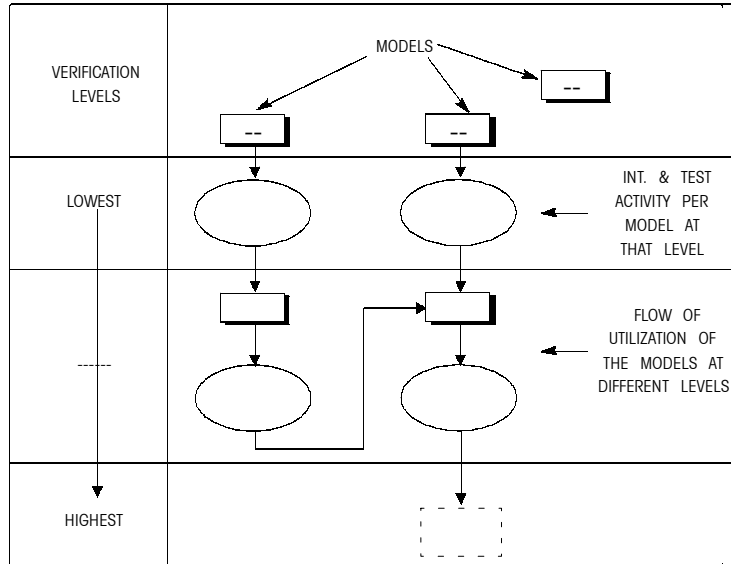

Figure D-1: Example of model philosophy format

D.8.7 Verification strategy

This clause shall be numbered 7 and shall describe the selected combination of the different verification methods at the applicable verification levels and stages, in general and for each requirement category (see ECSS-E-10-02 clause 5).

These strategies may be summarized in dedicated format tables (see Tables D-3, D-4, D-5 and Figure D-3).

D.8.8 Assembly integration and verification programme

This clause shall be numbered 8 and shall describe the details on the AIV activities and associated planning in the applicable stages. In particular Analysis, Review-of-Design, Inspection and AIT programmes shall be detailed through dedicated AIV activity sheets and planning. (see ECSS-E-10-02 clauses 5 and 6).

The selected tests and the AIV planning may be summarized in dedicated format tables (see Tables D-6, D-7, D-8 and D-9).

D.8.9 AIV tools

This clause shall be numbered 9 and shall describe high level definitions of the necessary AIV tools such as GSE, S/W facilities, special tools, simulators, analytical tools and AIT facilities.

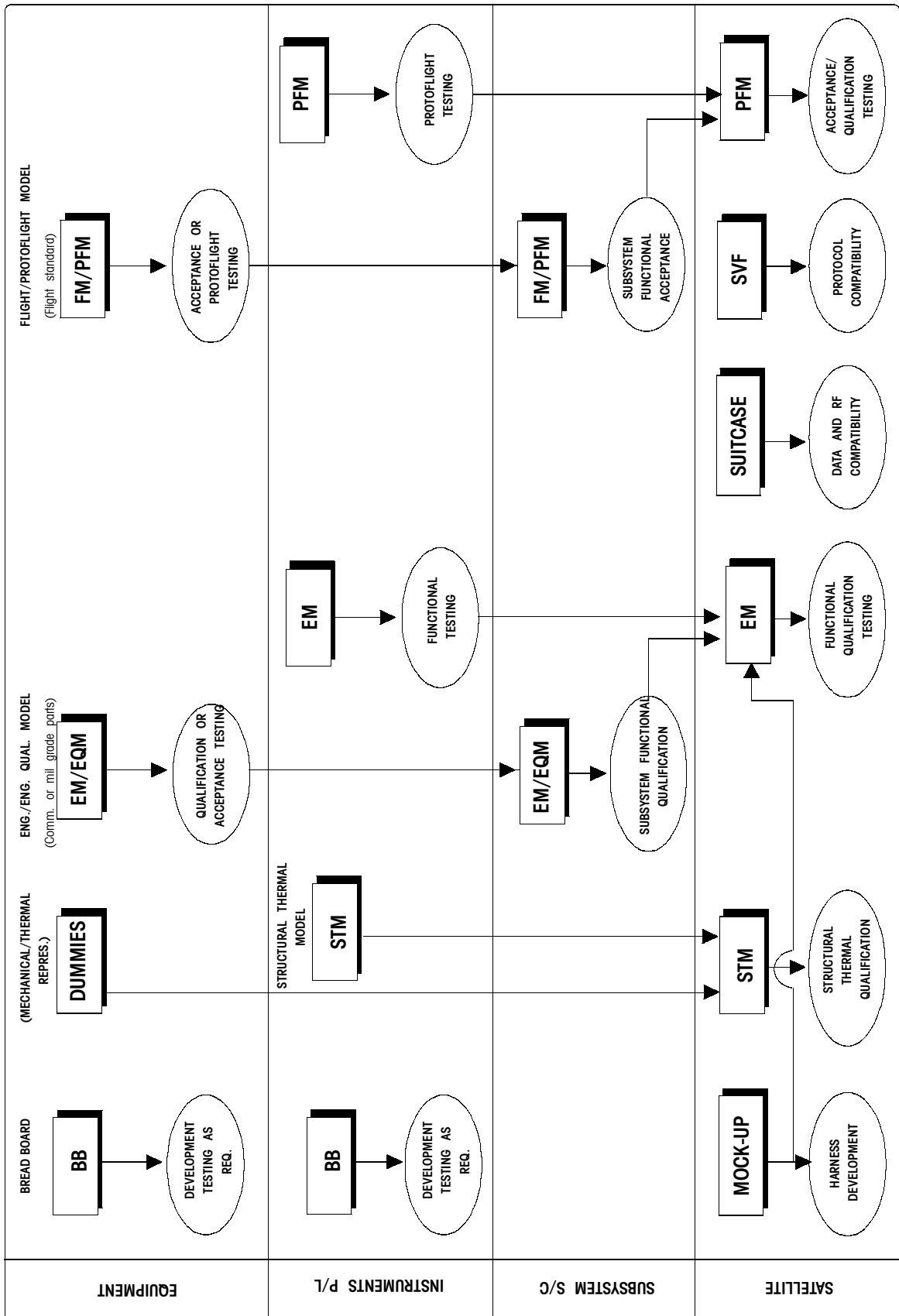

Figure D-2: Example of filled model philosophy format

D.8.10 Verification control methodology

This clause shall be numbered 10 and shall describe the proposed verification control methodology including the use of any verification data base.

D.8.11 Documentation

This clause shall be numbered 11 and shall describe the involved verification documents and their content as a tailoring of ECSS-E-10-02.

D.8.12 Organization and management

This clause shall be numbered 12 and shall describe the responsibility and management tools applicable to the described verification process with reference to ECSS-E-10-02.

Table D-1: Example of hardware matrix format

| No. | Subsystem | Abbr. | Qual. Status | Models | | | | Remarks |
|-----|--|-------|--------------|-----------------|--|------------|--|-----------------------|
| | | | | Types of models | | | | |
| | Equipment by equipment for each SS --- --- | | | | | Quantities | | Dummies simulators |

Qual. Status
 A = Off-the-shelf
 B = Minor modification
 C = Delta qualification required
 D = New development

Table D-2: Example of filled hardware matrix format

| No. | Subsystem/ Instrument | Abbr. | Qual. Status | DM | STM | EM | FM | SP | Remarks |
|-----|--|---|---|---------------------|--|--|--|----|--|
| 1 | Structure | STR | D | | 1 | | 1 | * | * STM Spare |
| 2 | Thermal Control | TCS | D | | 1 | * | 1 | 1 | * STM Spare |
| 3 | AOCS <ul style="list-style-type: none"> • Coarse Sun Sensor • Star Tracker • Star Tracker Electr. • Gyro package • Gyro Electronic • Reaction wheel • Wheel drive electronic • Actuator gyro electronic • Flap assembly • Attitude control electronic | CSS ST STE GYR GYE RW WDE ADE FL ACE | A A A A A A A A D D | | 2* 3* 3* 1* 4* 1* 1* 1* 2* 1* | 1 1 1 1 1 1 1 1 1 1 | 2 3 3 1 3 4 1 1 2** 1** | | * Dummy * Dummy * Dummy * Dummy * Dummy * Dummy * Dummy * Dummy * Dummy ** PFM * Dummy ** PFM |
| 4 | RCS <ul style="list-style-type: none"> • Tanks • Thrusters • Thrusters bracket • Latch valves • Filter • Flow meter • Fill & drain valves • Valve brackets • Pressure transducers • Pipework | | B(A) A D A A D A D A D | | 8* 12* 4* 11* 1* 1* 3* 2* 3* 1* | 8** 1 4** 1 1 1 1 2** 1 1** | 8 12 4 11 1 1 3 2 3 1 | | * Dummy ** from STM * Dummy * Dummy ** from STM * Dummy * Dummy * Dummy * Dummy * Dummy ** from STM * Dummy * Dummy ** from STM |
| 5 | Power <ul style="list-style-type: none"> • Power control unit • Battery regulator unit • Battery mgn unit • Pyro drive unit • Power distribution unit • Battery | PCU BRU BMU PYR PDU BATT | C A A C D A | 1 1 1 | 1* 1* 1* 1* 1* 2* | 1** 1 1 1** 1 2 | 1 1 1 1 1** 2 | | * Dummy ** EQM * Dummy * Dummy * Dummy ** EQM * Dummy ** PFM * Dummy |
| 6 | OBDH <ul style="list-style-type: none"> • Central terminal unit • Common pulsed distr. unit • Digital bus unit • Intelligent control unit • Mass memory unit • Remote bus interface | CTU CPDU DBU ICU MMU RSI | A A A C(D) D(C) A | | 1* 1* 4* 2* 1* 2* | 1 1 4 2** 1 2 | 1 1 4 2** 1 2 | | * Dummy * Dummy * Dummy * Dummy ** EQM * Dummy ** PFM * Dummy |
| 7 | Solar Array <ul style="list-style-type: none"> • Deployable panel • Yokes • Mid-panel body | | D D D | | 2* 1* 3* | 1 1** 1 | 2 2 1 | | * Dummy * Dummy ** from STM * Dummy |
| 8 | TT&C <ul style="list-style-type: none"> • Transponder • RF distribution unit • Antenna | | C A D | | 2* 1* 3* | 1** 1 1 | 2 1 3** | | * Dummy * Dummy * Dummy ** 1PFM ** 2EQM |
| 9 | Harness | | D | | 1 | 1 | 1 | | |
| 10 | Radio Instrument | | D | 1 | 1* | 1 | 1** | | * Dummy ** PFM |
| 11 | GPS | | | | 1* | 1 | 1** | | * Dummy ** PFM |
| 12 | Bloom | | D | | 1* | 1** | 1 | | * Dummy ** from STM |
| 13 | Magnetometer | | | | 1* | 1 | 1** | | * Dummy ** PFM |

Table D-3: Example of preliminary verification matrix format

| Requirement category | Verification levels | | |
|----------------------|--|-----|--------|
| | Highest | --- | Lowest |
| --- | | | |
| --- | Verification methods for each category | | |

Table D-4: Example of filled preliminary verification matrix format

| Requirement category | S/C level | Module level | Equipment level |
|------------------------------|------------|--------------|-----------------|
| Configuration | | | |
| Launcher interfaces | I | I, T | R, I |
| Ground segment interfaces | R, A, T | R, A | R, T |
| Payload interfaces & perfor. | R, A, I, T | R, A, I, T | N/A |
| Configuration/physical prop. | R, A, I | R, A, I, T | R, T, A, I |
| Light tightness | I, R | I, R, T | I, R |
| Data Manag. | | | |
| Data handling | T, A | T, A | R, T, A, I |
| S/W functions | T, A, R | T, A | R, T, A, I |
| Mechanical | | | |
| Venting | A | A | R |
| Mechanical | T, A | T, A | T, A |
| Mechanisms & pyro | T, A | T, A | A, I, T, R |
| Radiation protection | A | A | A |
| GNC | | | |
| Attitude and orbit control | T, A | T, A | T, A |
| Propulsion | | | |
| Reaction control | T, A | T, A | T, A |
| Communication | | | |
| Radio Frequency | T, A | T, A | T, A |
| Thermal | | | |
| Thermal | T, A | T, A | T, A |

Legend:

T = Test, A = Analysis, I = Inspection, R = Review of design

Table D-5: Example of verification strategy format

| External elements | Verification levels | | |
|-------------------------|---|------|--------|
| | Highest | ---- | Lowest |
| <p>----</p> <p>----</p> | <p>Flow of verification activities (test, analysis, ROD, inspection) in different stages with the indication of e.g. exchange of models and simulators.</p> | | |

STAGES

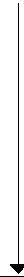

Table D-6: Example of test matrix format

| REQUIREMENT CATEGORY | TEST | TYPES OF TESTS | | | | REMARKS |
|--|------|----------------|--|--|--|---------|
| | | | | | | |
| ----- | | | | | | |
| APPLICATION OF TYPE OF TEST TO REQUIREMENT CATEGORIES IN DIFFERENT VERIFICATION STAGES | | | | | | |
| | | | | | | |

Table D-7: Example of filled test matrix format

| REQUIREMENT CATEGORY | S/C TESTS | | | | | | | | | | | | | REMARKS | |
|------------------------------|------------------|--------------------|----------|----------------|---------------|-----------|--------------------------|------------------|----------------|----------------------|---------------------|---------|----------------------|---------|---|
| | TRANSMISSIBILITY | DEPLOYMENT/RELEASE | ACOUSTIC | SINE VIBRATION | LEAKAGE/SNIFF | ALIGNMENT | ELECTR. PUNCT. INTERFACE | PAYLOAD TESTINGS | THERMAL VACUUM | GROUND SEGMENT COMP. | OPERATION DEMONSTR. | EMC/ESD | SUITS/CASE PROGRAMME | | |
| CONFIGURATION | | | | | | | | | | | | | | | |
| GROUND SEGMENT INTERFACES | | | | | | | | q/a | | | | | | q | |
| PAYLOAD INTERFACES & PERFOR. | | | | | | | q/a | | | | | | | | EXPERIMENT AFE |
| DATA MANAG. | | | | | | | | | | | | | | | |
| DATA HANDLING | | | | | | | q/a | | q/a | | | | | q | |
| S/W FUNCTIONS | | | | | | | q/a | | q/a | | | | | | |
| MECHANICAL | | | | | | | | | | | | | | | |
| MECHANICAL | q | | q/a | q/a | | | | | | | | | | | |
| MECHANISMS & PYRO | | q/a | | | | | | | | | | | | | |
| GNC | | | | | | | | | | | | | | | |
| ATTITUDE AND ORBIT CONTROL | | | | | | | q/a | | | | | | | | |
| PROPULSION | | | | | | | | | | | | | | | |
| REACTION CONTROL | | | | | q/a | | q/a | | | | | | | | |
| COMMUNICATION | | | | | | | | | | | | | | | |
| RADIOFREQUENCY | | | | | | | q/a | | q/a | | | | | q | |
| THERMAL | | | | | | | | | | | | | | | |
| THERMAL | | | | | | | | | a | | | | | | |
| POWER | | | | | | | | | | | | | | | |
| POWER GENER. AND DISTRIB. | | | | | | | q/a | | | | | | | | |
| GROUND OP.'S | | | | | | | | | | | | | | | |
| GROUND TESTING & CHECK-OUT | | | | | | q/a | q/a | | | | | | | | MGSE VERIF. DURING INT. & TEST ACTIVITIES |
| LAUNCH CAMPAIGN | | | | | | | | | | | q/a | | | | VERIF. DURING INT. & TEST ACTIVITIES |
| FLIGHT OP.'S | | | | | | | | | | | | | | | |
| FLIGHT OPERATIONS | | | | | | | q/a | q/a | | q/a | | | | | |
| MISSION | | | | | | | | | | | | | | | |
| ALIGNMENT & STABILITY | | | | | | q/a | | | | | | | | | |
| EMC | | | | | | | | | | | | | | | |

LEGEND:
q = qualification, a = acceptance

Annex E (normative)

Verification Control Document (VCD) - Document Requirements Definition (DRD)

E.1 Introduction

As required by ECSS-E-10-02, this document lists all the requirements to be verified with the selected methods in the applicable stages at the defined levels (in this sense it replaces the verification matrix of DRD annex C) and provides traceability during the implementation phase, how and when each requirement is planned to be verified and is actually verified.

The VCD requires formal concurrence by the customer and becomes part of the EIDP as detailed in ECSS-Q-20A.

E.2 Scope and applicability

E.2.1 Scope

This Document Requirements Definition (DRD) establishes the data content requirements for the VCD.

This DRD does not define format, presentation or delivery requirements for the VCD.

E.2.2 Applicability

This DRD is applicable to all projects using the ECSS Standards.

E.3 References

E.3.1 Glossary and dictionary

This DRD uses terminology and definitions controlled by:

| | |
|--------------|----------------------------------|
| ECSS-P-001 | Glossary of terms |
| ECSS-E-10-02 | Space engineering - Verification |

E.3.2 Source Document

This DRD defines the data requirements of a VCD as controlled by:

| | |
|--------------|----------------------------------|
| ECSS-E-10-02 | Space engineering - Verification |
|--------------|----------------------------------|

E.4 Definitions, abbreviations and symbols

E.4.1 Definitions

For the purposes of this DRD the definitions given in ECSS-P-001 and in ECSS-E-10-02 apply.

E.4.2 Abbreviations

The following abbreviations are defined and used within this DRD.

| Abbreviation | Meaning |
|---------------------|--|
| A | Analysis |
| AIV | Assembly, Integration and Verification |
| DRD | Document Requirements Definition |
| ECSS | European Cooperation for Space Standardization |
| EQ | Equipment |
| H/W | Hardware |
| I | Inspection |
| N/A | Not applicable |
| PDU | Power Distribution Unit |
| QUAL | Qualification |
| R | Review of Design |
| RCS | Reaction Control System |
| RFW | Request for Waiver |
| SS | Subsystem |
| SY | System |
| T | Test |
| VCB | Verification Control Board |
| VCD | Verification Control Document |

E.4.3 Symbols

N/A

E.5 Description and purpose

The VCD lists the requirements to be verified and the associated verification matrix. It also provides traceability on the verification process events and documentation and gives evidence of the verification status and close-out.

The VCD is used to monitor and control the verification process and to demonstrate to the customer, at the end of the relevant stages (e.g. qualification, acceptance) that verification has been completed.

E.6 Application and Interrelationship

The document is prepared at each verification level as required by the terms and conditions of the contract.

It may be an output of the project verification data base.

It is originated on the basis of the applicable specification and associated verification matrix (DRD annex C) in line with the verification approach and definitions contained in the AIV plan (DRD annex D).

E.7 VCD preliminary elements

E.7.1 Title

The document to be created based on this DRD shall be titled “[insert a descriptive modifier] VCD”.

The descriptive modifier shall be selected to clearly identify the applicable product and level.

EXAMPLE “PDU equipment VCD”
“RCS subsystem VCD”
“System VCD”

E.7.2 Title page

The title page for this document shall identify the project document identification number, title of the document, date of release and release authority.

E.7.3 Contents list

The contents list shall identify the title and location of every clause and major subclause, figure, table and annex contained in the document.

E.7.4 Foreword

A foreword shall be included which describes as many of the following items as are appropriate:

- identification of which organizational entity prepared the document;
- information regarding the approval of the document;
- identification of other organizations that contributed to the preparation of the document;
- a statement of effectivity identifying which other documents are cancelled and replaced in whole or in part;
- a statement of significant technical differences between this document and any previous document;
- the relationship of the document to other standards or documents.

E.7.5 Introduction

An introduction may be included to provide specific information or commentary about the technical content.

E.8 Content

E.8.1 Scope and applicability

This clause shall be numbered 1 and shall describe the scope, applicability and purpose of the VCD.

E.8.1.1 Scope

This subclause shall be numbered 1.1 and shall contain the following statements:

“This VCD provides evidence of the verification process for the [insert product and level identifier] of the [insert project identifier] project.

This VCD is based on the [insert requirement specification(s) identifier(s)] requirements and associated verification matrix (if any)”.

E.8.1.2 Purpose

This subclause shall be numbered 1.2 and shall contain the following statements:

“This VCD keeps under control the verification process and demonstrates the verification completion at the end of the relevant stages.”

E.8.2 References

This clause shall be numbered 2 and shall contain the following subclauses.

E.8.2.1 Normative references

This subclause shall be numbered 2.1 and shall contain the following statements:

“This document incorporates, by dated or undated reference, provisions from other publications. These normative references are cited at appropriate places in the text and publications are listed hereafter. For dated references, subsequent amendments to or revisions of any of these apply to this document only when incorporated in it by amendment or revision. For undated references, the latest edition of the publication referred to applies.

[insert document identifier] [insert document title].”

Typically the reference documents are the product specification, the associated verification matrix and the AIV plan.

E.8.2.2 Informative references

This subclause shall be numbered 2.2 and shall contain the following statement:

“The following documents, although not a part of this VCD, amplify or clarify its contents:

[insert document identifier] [insert document title].”

E.8.3 Definitions and abbreviations

This clause shall be numbered 3 and shall contain the following subclauses.

E.8.3.1 Definitions

This subclause shall be numbered 3.1 and shall list any applicable project dictionary or glossary, and all unusual terms or terms with a meaning specific to the VCD, with the definition for each term.

If a project dictionary or glossary is applicable, insert the following sentence:

“The definitions of [insert title and identifier of applicable dictionaries or glossaries] apply to this document.”

Insert the following sentence:

“The following terms and definitions are specific to this document:

[insert term] [insert definition].”

E.8.3.2 Abbreviations

This subclause shall be numbered 3.2 and shall list all abbreviations used in the VCD with the full spelled-out meaning or phrase for each abbreviation.

E.8.4 Verification subject

This clause shall be numbered 4 and shall describe the subject of the verification control approach, involved documentation, formats and computerized tool (if any).

In particular it shall address the requirements to be verified (i.e. specification(s) involved), call up the verification methods/levels/stages definitions, explain the verification close-out philosophy and introduce the VCD sheets.

E.8.5 Verification control document sheets

This clause shall be numbered 5 and shall collect the verification control document sheets properly filled for the applicable requirements.

They may be presented in a dedicated format table (see Figure E-1 and Table E-1).

The definitions of the terms are in line with the ECSS-E-10-02.

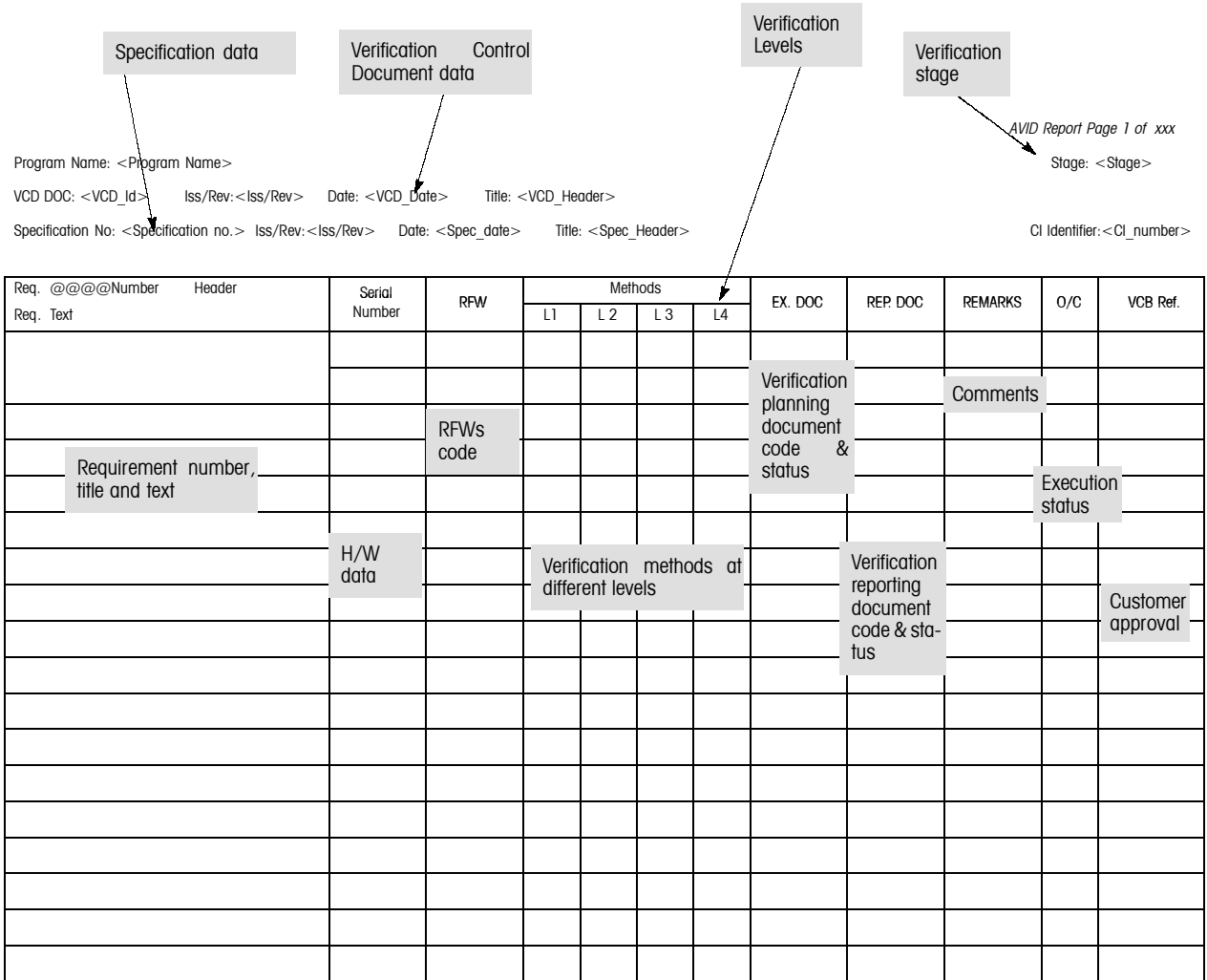

Figure E-1: Example of VCD sheet format

Table E-1: Example of filled format table

AVID Report Page 1 of 100

Program Name: SATELLITE

Stage QUAL

VCD DOC: SAT-VCD-001 Iss/Rev 1/- Date: 01.01.2000 Title: SATELLITE SYSTEM VCD

Specification No: SAT-SPEC-001 Iss/Rev 1/- Date: 01.12.1998 Title: Satellite System Specification

CI Identifier: 1-001-01

| Req. Number Req. Text | Header | Serial Number | RFW | Methods | | | | EX. DOC | REP. DOC | REMARKS | O/C | VCB Ref. |
|--|--------------------------------|------------------|-----|---------|----|----|---|------------|------------|----------|-----|-------------|
| | | | | SY | SS | EQ | - | | | | | |
| 4.1 The Satellite System mass shall not exceed 2 Tons | Mass | 01 | - | T | | | | SAT-PR-001 | SAT-RP-001 | | C | SAT-MIN-001 |
| | | 01 | | A | | | | | SAT-RP-002 | | C | SAT-MIN-001 |
| | | 01 | | | | | | | SAT-RP-006 | VER.REP | C | SAT-MIN-001 |
| | | 011 | | | A | | | | N...A Rep. | | C | |
| | | 0111 | | | | T | | | N...A Rep. | | C | |
| 4.1 The Satellite System Electrical Interfaces with the Launcher shall be in agreement with Fig 4.2-1 | Launcher Electrical Interfaces | 01 | | I | | | | | SAT-RP-003 | | C | SAT-MIN-002 |
| | | 01 | | R | | | | | SAT-RP-004 | | C | SAT-MIN-002 |
| | | 01 | | | | | | | SAT-RP-007 | VER. REP | O | |
| | | 011 | | | R | | | | SEP-RP-001 | | C | |
| | | 0111 | | | | I | | | CON-RP-001 | | C | |
| | | | | | | | | | | | | |
| | | | | | | | | | | | | |
| | | | | | | | | | | | | |
| | | | | | | | | | | | | |
| | | | | | | | | | | | | |
| | | | | | | | | | | | | |
| | | | | | | | | | | | | |
| | | | | | | | | | | | | |

(This page is intentionally left blank)

Annex F (normative)

Test specification - Document Requirements Definition (DRD)

F.1 Introduction

As required by ECSS-E-10-02, this document details the test requirements for specific test activity(ies) described in the AIV plan activity sheets for special purposes (e.g. to interface with a test facility).

This document is applicable to an intermediate step in the test process definition between the overall planning (AIV plan) and the specific test procedure. It may be combined with the above mentioned documents, depending on actual project requirements.

F.2 Scope and applicability

F.2.1 Scope

This Document Requirements Definition (DRD) establishes the data content requirements for the Test specification.

This DRD does not define format, presentation or delivery requirements for the test specification.

F.2.2 Applicability

This DRD is applicable to all projects using the ECSS Standards.

F.3 References

F.3.1 Glossary and dictionary

This DRD uses terminology and definitions controlled by:

| | |
|--------------|---|
| ECSS-P-001 | Glossary of terms |
| ECSS-E-10-02 | Space engineering - Verification |
| ECSS-E-10-03 | Space engineering - Testing (to be published) |

F.3.2 Source Document

This DRD defines the data requirements of a test specification as controlled by:

| | |
|--------------|----------------------------------|
| ECSS-E-10-02 | Space engineering - Verification |
|--------------|----------------------------------|

F.4 Definitions, abbreviations and symbols

F.4.1 Definitions

For the purposes of this DRD the definitions given in ECSS-P-001 and in ECSS-E-10-02 apply.

F.4.2 Abbreviations

The following abbreviations are defined and used within this DRD.

| Abbreviation | Meaning |
|---------------------|--|
| AIV | Assembly, Integration and Verification |
| DRD | Document Requirements Definition |
| ECSS | European Cooperation for Space Standardization |
| GSE | Ground Support Equipment |
| N/A | Not applicable |
| PA | Product Assurance |
| QA | Quality Assurance |
| VCD | Verification Control Document |

F.4.3 Symbols

N/A

F.5 Description and purpose

The test specification describes in detail the test requirements applicable to any major test activity included in the AIV plan. In particular it defines the purpose of the test, the test approach, the test article and the set-up, the required GSE, test equipment and instrumentation, test conditions, test sequence, test facility, pass/fail criteria, required documentation, participants and test schedule.

The document is used as an input to the test procedures, as a requirements document for booking the environmental test facility and to provide evidence to the customer on certain details of the test activity in advance of the activity itself.

F.6 Application and interrelationship

The document shall cover all verification levels as necessary (it is typically required for complex testing).

It shall conform to the AIV plan (DRD annex D) activity sheets taking into account the applicable methodological requirements of the Test Requirement Specification (see ECSS-E-10-02).

It is used as a basis for writing the relevant test procedures (DRD annex G) and test report (DRD annex H).

In writing the test specification possible overlaps with the test procedure is minimized (i.e. the test specification gives emphasis on requirements, the test procedure on operative step by step instructions).

The information about its title page (see subclause F.7.2) shall be recorded in the VCD (DRD annex E).

F.7 Test specification preliminary elements

F.7.1 Title

The document to be created based on this DRD shall be titled “[insert a descriptive modifier] test specification”.

The descriptive modifier shall be selected to clearly identify the product and the relevant test activity.

EXAMPLE “Solar array life test specification”
“Service module modal survey test specification”
“Satellite integrated system test specification”

F.7.2 Title page

The title page for this document shall identify the project document identification number, title of the document, date of release and release authority.

F.7.3 Contents list

The contents list shall identify the title and location of every clause and major subclause, figure, table and annex contained in the document.

F.7.4 Foreword

The foreword shall be included which describes as many of the following items as are appropriate:

- identification of the organizational entity which prepared the document;
- information regarding the approval of the document;
- identification of other organizations that contributed to the preparation of the document;
- a statement of effectivity identifying which other documents are cancelled and replaced in whole or in part;
- a statement of significant technical differences between this document and any previous document;
- the relationship of the document to other standards or documents.

F.7.5 Introduction

An introduction may be included to provide specific information or commentary about the technical content.

F.8 Content

F.8.1 Scope and applicability

This clause shall be numbered 1 and shall describe the scope, applicability and purpose of the test specification.

F.8.1.1 Scope

This subclause shall be numbered 1.1 and shall contain the following statements:

“This test specification defines the test requirements for the [insert product and test identifier] of the [insert project identifier] project.

This test specification is compatible with the activity sheets of the [insert AIV plan identifier] and its associated requirements.”

F.8.1.2 Purpose

This subclause shall be numbered 1.2 and shall contain the following statements:

“This test specification represents an intermediate step in the test process definition between the AIV plan and the specific test procedure. It is aimed to specify the outline of the test and the supporting infrastructure.”

The document is used as an input to the test procedures, as a requirements document for booking the environmental test facility and to inform the customer of certain details of the test activity in advance of the activity itself.

F.8.2 References

This clause shall be numbered 2 and shall contain the following subclauses.

F.8.2.1 Normative references

This subclause shall be numbered 2.1 and shall contain the following statements:

“This document incorporates, by dated or undated reference, provisions from other publications. These normative references are cited at appropriate places in the text and publications are listed hereafter. For dated references, subsequent amendments to or revisions of any of these apply to this document only when incorporated in it by amendment or revision. For undated references, the latest edition of the publication referred to applies.

[insert document identifier] [insert document title].”

Typically the reference documents are the AIV plan and the test requirement specification.

F.8.2.2 Informative references

This subclause shall be numbered 2.2 and shall contain the following statement:

“The following documents, although not a part of this test specification, amplify or clarify its contents:

[insert document identifier] [insert document title].”

F.8.3 Definitions and abbreviations

This clause shall be numbered 3 and shall contain the following subclauses.

F.8.3.1 Definitions

This subclause shall be numbered 3.1 and shall list any applicable project dictionary or glossary, and all unusual terms or terms with a meaning specific to the test specification, with the definition for each term.

If a project dictionary or glossary is applicable, insert the following sentence:

“The definitions of [insert title and identifier of applicable dictionaries or glossaries] apply to this document.”

Insert the following sentence:

“The following terms and definitions are specific to this document:

[insert term] [insert definition].”

F.8.3.2 Abbreviations

This subclause shall be numbered 3.2 and shall list all abbreviations used in the test specification with the full spelled-out meaning or phrase for each abbreviation.

F.8.4 Requirements to be verified

This clause shall be numbered 4 and shall list the requirements to be verified (in correlation to the VCD) in the specific test and provides traceability where in the test the requirement is covered.

F.8.5 Test approach

This clause shall be numbered 5 and shall summarize the objectives of and the approach to the test activity.

F.8.6 Test description

This clause shall be numbered 6 and shall summarize the configuration of the test article, the test set-up the necessary GSE, the test conditions and the applicable constraints.

F.8.7 Test facility

This clause shall be numbered 7 and shall define the applicable test facility requirements (if any) together with required instrumentation, data acquisition and test equipment.

It shall include quality assurance requirements applicable to the facility.

F.8.8 Test sequence

This clause shall be numbered 8 and shall define the test activity flow and the associated requirements.

F.8.9 Pass/fail criteria

This clause shall be numbered 9 and shall define the test pass/fail criteria in relation to the inputs and output.

F.8.10 Test documentation

This clause shall be numbered 10 and shall define the requirements for the involved documentation (including test procedure, test report and PA/QA records).

F.8.11 Test organization

This clause shall be numbered 11 and shall define the test responsibilities, required participants and the schedule outline.

(This page is intentionally left blank)

Annex G (normative)

Test procedure - Document Requirements Definition (DRD)

G.1 Introduction

As required by ECSS-E-10-02, this document provides detailed step-by-step instructions for conducting test activities in accordance with the relevant test requirements.

The test procedure states objectives of the activity, the applicable documents, the references to the relevant test specification, the participants required, the article and tools configuration list, and the step-by-step test procedure.

G.2 Scope and applicability

G.2.1 Scope

This Document Requirements Definition (DRD) establishes the data content requirements for the test procedure.

This DRD does not define format, presentation or delivery requirements for the test procedure.

G.2.2 Applicability

This DRD is applicable to all projects using the ECSS Standards.

G.3 References

G.3.1 Glossary and dictionary

This DRD uses terminology and definitions controlled by:

| | |
|--------------|---|
| ECSS-P-001 | Glossary of terms |
| ECSS-E-10-02 | Space engineering - Verification |
| ECSS-E-10-03 | Space engineering - Testing (to be published) |

G.3.2 Source document

This DRD defines the data requirements of a test procedure as controlled by:

| | |
|--------------|----------------------------------|
| ECSS-E-10-02 | Space engineering - Verification |
|--------------|----------------------------------|

G.4 Definitions, abbreviations and symbols

G.4.1 Definitions

For the purposes of this DRD the definitions given in ECSS-P-001 and in ECSS-E-10-02 apply.

G.4.2 Abbreviations

The following abbreviations are defined and used within this DRD.

| Abbreviation | Meaning |
|---------------------|--|
| AIV | Assembly, Integration and Verification |
| DRD | Document Requirements Definition |
| ECSS | European Cooperation for Space Standardization |
| ICD | Interface Control Document |
| N/A | Not applicable |
| PA | Product Assurance |
| QA | Quality Assurance |
| QC | Quality Control |
| VCD | Verification Control Document |

G.4.3 Symbols

N/A

G.5 Description and purpose

The test procedure gives directions for conducting a test activity in terms of description, resources, constraints and step-by-step procedure.

The document is used and filled-in as appropriate during the execution and becomes the “as-run” procedure.

G.6 Application and interrelationship

The document is prepared for each test to be conducted at each verification level. The same procedure may be used in case of recurring tests.

It incorporates the requirements of the test specification (DRD annex F) and uses detailed information contained in other project documentation (e.g. drawings, ICDs).

Several procedures often originate from a single test specification. In certain circumstances involving a test facility (for example during environmental test) several test procedures may be combined in an overall integrated test procedure.

The “as-run” procedure becomes part of the relevant test report (DRD annex H). Overlaps with the test specification is minimized (see DRD annex F).

Its title page data (see subclause G.7.2) is recorded in the VCD (DRD annex E).

G.7 Test procedure preliminary elements

G.7.1 Title

The document to be created by this DRD shall be titled “[insert a descriptive modifier] test procedure”.

The descriptive modifier shall be selected to clearly identify the applicable product and the type of test.

EXAMPLE “Thermal control functional test procedure”
“Pressurized module human factors test procedure”
“Satellite thermal balance test procedure”

G.7.2 Title page

The title page shall identify the project document identification number, title of the document, date of release and release authority.

G.7.3 Contents list

The contents list shall identify the title and location of every clause and major subclause, figure, table and annex contained in the document.

G.7.4 Foreword

A foreword shall be included which describes as many of the following items as are appropriate:

- identification of which organizational entity prepared the document;
- information regarding the approval of the document;
- identification of other organizations that contributed to the preparation of the document;
- a statement of effectivity identifying which other documents are cancelled and replaced in whole or in part;
- a statement of significant technical differences between this document and any previous document;
- the relationship of the document to other standards or documents.

G.7.5 Introduction

An introduction may be included to provide specific information or commentary about the technical content.

G.8 Content

G.8.1 Scope and applicability

This clause shall be numbered 1 and shall describe the scope, applicability and purpose of the test procedure.

G.8.1.1 Scope

This subclause shall be numbered 1.1 and shall contain the following statements:

“This test procedure defines the instructions for the conducting [insert product and test identifier] of the [insert project identifier] project.”

“This test procedure is based on the requirements of the [insert AIV plan identifier] and of [insert test specification identifier].”

G.8.1.2 Purpose

This subclause shall be numbered 1.2 and shall contain the following statements:

“This test procedure defines in detail the test and the corresponding “as-run” procedure will become part of the test report.”

G.8.2 References

This clause shall be numbered 2 and shall contain the following subclauses.

G.8.2.1 Normative references

This subclause shall be numbered 2.1 and shall contain the following statements:

“This document incorporates, by dated or undated reference, provisions from other publications. These normative references are cited at appropriate places in the text and publications are listed hereafter. For dated references, subsequent amendments to or revisions of any of these apply to this document only when incorporated in it by amendment or revision. For undated references, the latest edition of the publication referred to applies.

[insert document identifier] [insert document title].”

Reference documents are normally the AIV plan and the test specification.

G.8.2.2 Informative references

This subclause shall be numbered 2.2 and shall contain the following statement:

“The following documents, although not a part of this test procedure, amplify or clarify its contents:

[insert document identifier] [insert document title].”

G.8.3 Definitions and abbreviations

This clause shall be numbered 3 and shall contain the following subclauses.

G.8.3.1 Definitions

This subclause shall be numbered 3.1 and shall list any applicable project dictionary or glossary, and all unusual terms or terms with a meaning specific to the test procedure, with the definition for each term.

If a project dictionary or glossary is applicable, insert the following sentence:

“The definitions of [insert title and identifier of applicable dictionaries or glossaries] apply to this document.”

Insert the following sentence:

“The following terms and definitions are specific to this document:

[insert term] [insert definition].”

G.8.3.2 Abbreviations

This subclause shall be numbered 3.2 and shall list all abbreviations used in the test procedure with the full spelled-out meaning or phrase for each abbreviation.

G.8.4 Requirements to be verified

This clause shall be numbered 4 and shall list the requirements to be verified in the specific test and provides traceability where in the test the requirement is covered.

G.8.5 Test article

This clause shall be numbered 5 and shall identify the test article configuration (including any reference to the relevant test configuration list) and the deviation from the specified standard (if any).

G.8.6 Test set-up

This clause shall be numbered 6 and shall define the required test set-up.

G.8.7 GSE required

This clause shall be numbered 7 and shall describe the GSE involved in the test activity.

G.8.8 Test equipment and instrumentation

This clause shall be numbered 8 and shall describe the equipment and instrumentation involved, including fixtures.

G.8.9 Test facility

This clause shall be numbered 9 and shall define the applicable test facility and the data handling system (if any).

G.8.10 Test conditions

This clause shall be numbered 10 and shall define the applicable standards, the applicable test conditions (in terms of levels, duration and tolerances) and the test data acquisition and reduction.

G.8.11 Documentation required

This clause shall be numbered 11 and shall describe the documentation required to support the test activity.

G.8.12 Participants required

This clause shall be numbered 12 and shall define the allocation of responsibilities and resources allocation.

G.8.13 Test constraints and operations

This clause shall be numbered 13 and shall define special conditions and hazards, operational constraints, rules for test management relating to changes in procedure, failures, reporting and signing-off procedure.

It shall include also QA/PA aspects.

G.8.14 Step-by-step procedure

This clause shall be numbered 14 and provides detailed instructions including required and actual results with tolerances, pass/fail criteria where applicable, identification of specific steps to be witnessed by QA personnel.

The step-by-step instructions may be organized in specific format tables (see Tables G-1 and G-2).

The definitions of the terms are in line with ECSS-E-10-02.

Table G-1: Example of step by step procedure format

Test title:

| Step | Activity description | Required result | Actual result | Conductor sign. & date | QC/QA stamp | Remarks |
|------|----------------------|-----------------|---------------|------------------------|-------------|---------|
| | | | | | | |

Table G-2: Example of filled format

Test title: Physical Properties Test

| Step | Activity description | Required result | Actual result | Conductor sign. & date | QC/QA stamp | Remarks |
|------|--|--|--|------------------------|--------------------|---------|
| 03 | Install the test article on the COG machine and perform the COG test per facility test procedure PR-001 using the reference system of Figure 1 | $X_G = (1\ 000 \pm 0,5)\ \text{mm}$ $Y_G = (1\ 500 \pm 0,5)\ \text{mm}$ $Z_G = (750 \pm 0,5)\ \text{mm}$ | $X_G = 1\ 000,3\ \text{mm}$ $Y_G = 1\ 499,8\ \text{mm}$ $Z_G = 750,3\ \text{mm}$ | MR. ONE 7/10/99 | MR. TWO 7/10/99 | |

Annex H (normative)

Test Report - Document Requirements Definition (DRD)

H.1 Introduction

As required by ECSS-E-10-02, this document describes the results obtained for each test performed, and discusses the conclusions drawn in the light of the requirements.

This report shall contain the introduction, the test results including the “as-run” test procedures and the conclusions reached, with particular emphasis on the close-out of the relevant verification requirements including any deviations therefrom.

H.2 Scope and applicability

H.2.1 Scope

This Document Requirements Definition (DRD) establishes the data content requirements for the test report.

This DRD does not define format, presentation or delivery requirements for the test report.

H.2.2 Applicability

This DRD is applicable to all projects using the ECSS Standards.

H.3 References

H.3.1 Glossary and dictionary

This DRD uses terminology and definitions controlled by:

| | |
|--------------|---|
| ECSS-P-001 | Glossary of terms |
| ECSS-E-10-02 | Space engineering - Verification |
| ECSS-E-10-03 | Space engineering - Testing (to be published) |

H.3.2 Source document

This DRD defines the data requirements of a test report as controlled by:

| | |
|--------------|----------------------------------|
| ECSS-E-10-02 | Space engineering - Verification |
|--------------|----------------------------------|

H.4 Definitions, abbreviations and symbols

H.4.1 Definitions

For the purposes of this DRD the definitions given in ECSS-P-001 and in ECSS-E-10-02 apply.

H.4.2 Abbreviations

The following abbreviations are defined and used within this DRD.

| Abbreviation | Meaning |
|---------------------|--|
| A | Analysis |
| ACC | Acceptance |
| APPR | Approval |
| C | Closed |
| CI | Configuration Item |
| DRD | Document Requirements Definition |
| ECSS | European Cooperation for Space Standardization |
| EQ | Equipment |
| FM | Flight Model |
| ID | Identifier |
| N/A | Not applicable |
| QUAL | Qualification |
| REQ | Requirement |
| SS | Subsystem |
| SY | System |
| T | Test |
| VCD | Verification Control Document |

H.4.3 Symbols

N/A

H.5 Description and purpose

The test report describes the execution of a particular test and the results obtained.

It contains the as-run procedure with supporting data, the anomalies and the evaluation of the test data in comparison with the requirements.

The principal use is to provide the customer with the evidence of the performed test activity in verification close-out of the relevant requirements.

H.6 Application and interrelationship

A document is prepared for each verification level and for each test performed.

It responds to the requirements contained in the product specification and of the test specification (DRD annex F) and test procedure (DRD annex G).

In case of environmental tests, pertinent data about the test facility is also given.

It is an input to a verification report (DRD annex L) in case of multimethod verification.

Its title page data (see subclause H.7.2) is recorded in the VCD (DRD annex E).

H.7 Test report preliminary elements

H.7.1 Title

The document to be created based on this DRD shall be titled “[insert a descriptive modifier] test report”

The descriptive modifier shall be selected to clearly identify the applicable product and type of test.

EXAMPLE “Solar sensor (FM1) thermal vacuum test report”
“Secondary structure vibration test report”

H.7.2 Title page

The title page for this document shall identify the project document identification number, title of the document, date of release and release authority.

H.7.3 Contents list

The contents list shall identify the title and location of every clause and major subclause, figure, table and annex contained in the document.

H.7.4 Foreword

A foreword shall be included which describes as many of the following items as are appropriate:

- identification of which organizational entity prepared the document;
- information regarding the approval of the document;
- identification of other organizations that contributed to the preparation of the document;
- a statement of effectivity identifying which other documents are cancelled and replaced in whole or in part;
- a statement of significant technical differences between this document and any previous document;
- the relationship of the document to other standards or documents.

H.7.5 Introduction

An introduction may be included to provide specific information or commentary about the technical content.

H.8 Content

H.8.1 Scope and applicability

This clause shall be numbered 1 and shall describe the scope, applicability and purpose of the test report.

H.8.1.1 Scope

This subclause shall be numbered 1.1 and shall contain the following statements:

“This test report contains the test results for [insert product and test identifier] of the [insert project identifier] project.

This test report is based on requirements on the [insert product specification identifier], on the [insert test specification identifier] and on the [insert test procedure identifier].”

H.8.1.2 Purpose

This subclause shall be numbered 1.2 and shall contain the following statements:

“This test report provides evidence of the test activities performed in the verification close-out of the relevant requirements.”

H.8.2 References

This clause shall be numbered 2 and shall contain the following subclauses.

H.8.2.1 Normative references

This subclause shall be numbered 2.1 and shall contain the following statements:

“This document incorporates, by dated or undated reference, provisions from other publications. These normative references are cited at appropriate places in the text and publications are listed hereafter. For dated references, subsequent amendments to or revisions of any of these apply to this document only when incorporated in it by amendment or revision. For undated references, the latest edition of the publication referred to applies.

[insert document identifier] [insert document title].”

Typically the reference documents are the product specification, the test specification and the test procedure.

H.8.2.2 Informative references

This subclause shall be numbered 2.2 and shall contain the following statement:

“The following documents, although not a part of this test report, amplify or clarify its contents:

[insert document identifier] [insert document title].”

H.8.3 Definitions and abbreviations

This clause shall be numbered 3 and shall contain the following subclauses.

H.8.3.1 Definitions

This subclause shall be numbered 3.1 and shall list any applicable project dictionary or glossary, and all unusual terms or terms with a meaning specific to the test report, with the definition for each term.

If a project dictionary or glossary is applicable, insert the following sentence:

“The definitions of [insert title and identifier of applicable dictionaries or glossaries] apply to this document.”

Insert the following sentence:

“The following terms and definitions are specific to this document:

[insert term] [insert definition].”

H.8.3.2 Abbreviations

This subclause shall be numbered 3.2 and shall list all abbreviations used in the test report with the full spelled-out meaning or phrase for each abbreviation.

H.8.4 Test results

This clause shall be numbered 4 and shall contain the as-run procedure with supporting data (including test facility results, as applicable).

H.8.5 Anomalies

This clause shall be numbered 5 and shall include the list of deviations, the nonconformance including failures, the problems.

H.8.6 Conclusions

This clause shall be numbered 6 and shall summarize the test evaluation, the comparison with the requirements and the verification close-out judgement.

Separate test analyses shall be cross-referenced.

The requirement close-out may be summarized in a format table to be prepared for each requirement or group of requirements involved (see Figures H-1 and H-2).

The definitions of the terms are in line with ECSS-E-10-02.

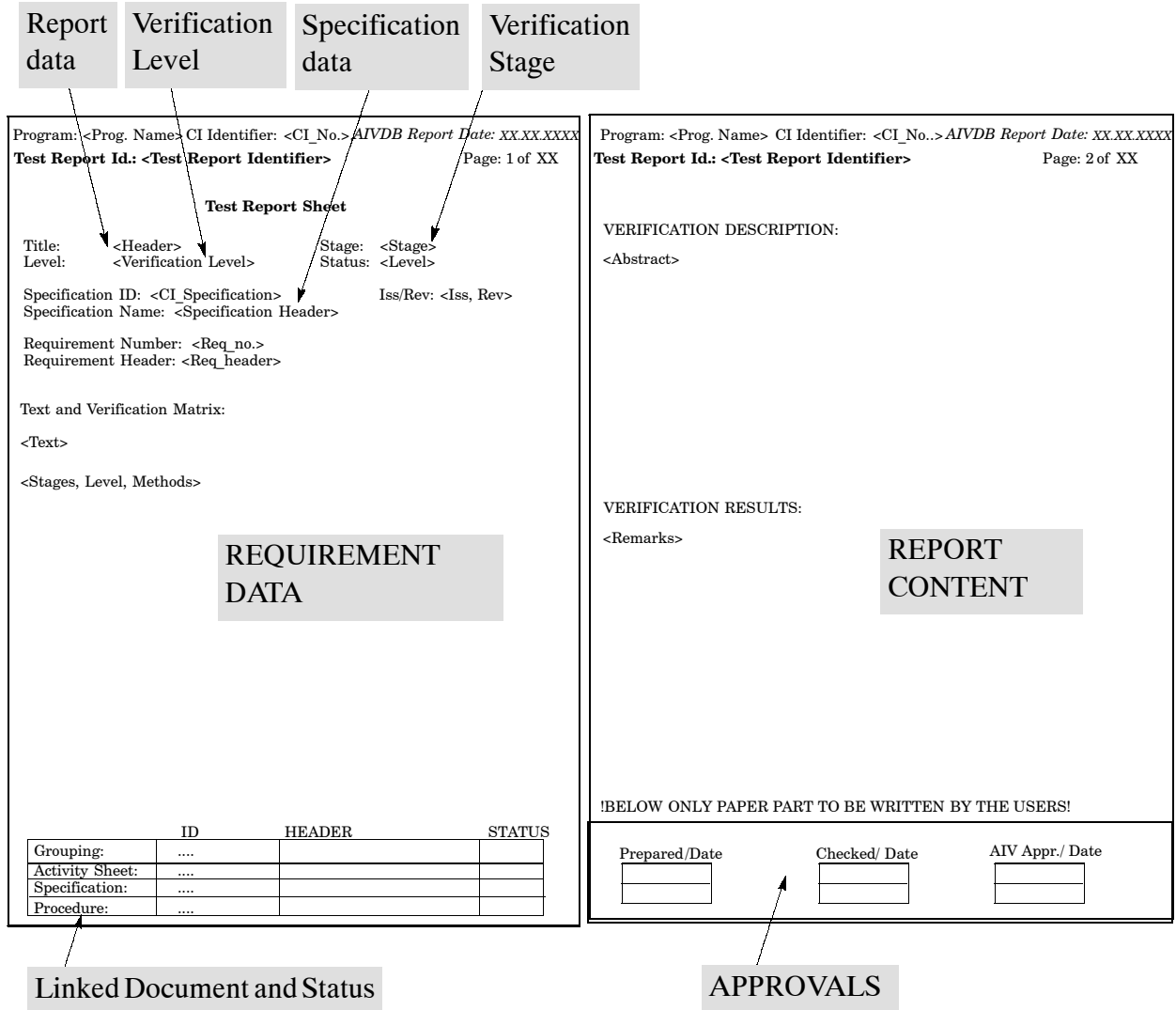

Figure H-1: Example of test report sheet

Program: SATELLITE CI Identifier: 1-000-1AIVDB Report Date: 01.12.1999
Test Report Id.: SAT-RP-001 Page: 1 of 2

Test Report Sheet

Title: Physical Properties Test Stage: QUALIFICATION
 Level: SYSTEM Status: Closed

Specification ID: SAT-SPEC-001 Iss/Rev: 1/-
 Specification Name: SATELLITE SYSTEM SPECIFICATION

Requirement Number: 4.1
 Requirement Header: Mass

Text and Verification Matrix:
 The Satellite System shall not exceed 2 t.

| | | | |
|------------|-----|----|---|
| Stage | SY | SS | - |
| QUAL | T.A | A | - |
| ACC | T | | - |
| PRE-LAUNCH | - | - | - |

| ID | HEADER | STATUS |
|-----------------|------------|-----------------------------------|
| Grouping: | G-MASS-T | Physical Properties C |
| Activity Sheet: | A-4.1.2 | Physical Properties C |
| Specification: | SAT-TS-001 | Physical Properties System Spec - |
| Procedure: | SAT-PR-001 | Physical Properties Procedure - |

Program: SATELLITE CI Identifier: 1-000-1AIVDB Report Date: 01.12.1999
Test Report Id.: SAT-RP-001 Page: 2 of 2

VERIFICATION DESCRIPTION:
 The Requirement has been verified by a means of a test at system level as part of the physical Properties System Test which is combined with system mass budget analysis based on the equipment test results.

VERIFICATION RESULTS:
 Dry satellite mass 1,5 t in line with the expected results. Verification successfully closed-out.

| Prepared /Date | Checked/ Date | AIV Appr./ Date |
|----------------|---------------|-----------------|
| Mr. One | Mr. Two | Mr. Three |

Figure H-2: Example of filled format

Annex I (normative)

Analysis report - Document Requirements Definition (DRD)

I.1 Introduction

As required by ECSS-E-10-02, this document describes for each analysis, the relevant assumptions, the methods and techniques used and results obtained.

It provides evidence that the relevant requirements have been verified and indicates deviations, if any.

I.2 Scope and applicability

I.2.1 Scope

This Document Requirements Definition (DRD) establishes the data content requirements for the analysis report.

This DRD does not define format, presentation or delivery requirements for the analysis report.

I.2.2 Applicability

This DRD is applicable to all projects using the ECSS Standards.

I.3 References

I.3.1 Glossary and dictionary

This DRD uses terminology and definitions controlled by:

ECSS-P-001 Glossary of terms

ECSS-E-10-02 Space engineering - Verification

I.3.2 Source document

This DRD defines the data requirements of an analysis report as controlled by:

ECSS-E-10-02 Space engineering - Verification

I.4 Definitions, abbreviations and symbols

I.4.1 Definitions

For the purposes of this DRD the definitions given in ECSS-P-001 and in ECSS-E-10-02 apply.

I.4.2 Abbreviations

The following abbreviations are defined and used within this DRD.

| Abbreviation | Meaning |
|---------------------|--|
| A | Analysis |
| ACC | Acceptance |
| AIV | Assembly, Integration and Verification |
| APPR | Approval |
| C | Closed |
| CI | Configuration Item |
| DRD | Document Requirements Definition |
| ECLS | Environmental Control and Life Support |
| ECSS | European Cooperation for Space Standardization |
| EPS | Electrical Power System |
| ID | Identifier |
| N/A | Not applicable |
| QUAL | Qualification |
| REQ | Requirement |
| SS | Subsystem |
| SY | System |
| T | Test |
| VCD | Verification Control Document |

I.4.3 Symbols

N/A

I.5 Description and purpose

The analysis report describes the execution of the test and the results of the analysis.

It contains the method of analysis and the assumptions used. It describes the model, presents the results of the analysis and the conclusions.

Its principal use is to provide the customer with the evidence of the satisfactory performance of analyses for verification close-out of the relevant requirements.

I.6 Application and interrelationship

The document is prepared for each verification level and for each analysis performed.

It is prepared on the basis of the requirements contained in the relevant AIV plan (DRD annex D) activity sheet.

It covers references, a specific report of the test prediction/correlation in case of analysis model validation with a test.

It is an input to a verification report (DRD annex L) in case of multimethod verification.

Its title page data (see subclause I.7.2) is recorded in the VCD (DRD annex E).

I.7 Analysis report preliminary elements

I.7.1 Title

The document to be created based on this DRD shall be titled “[insert a descriptive modifier] analysis report”.

The descriptive modifier shall be selected to clearly identify the applicable product and type of analysis.

EXAMPLE “ECLS functional analysis report”
“EPS power budget analysis report”
“Satellite mission analysis report”

I.7.2 Title page

The title page for this document shall identify the project document identification number, title of the document, date of release and release authority.

I.7.3 Contents list

The contents list shall identify the title and location of every clause and major subclause, figure, table and annex contained in the document.

I.7.4 Foreword

A foreword shall be included which describes as many of the following items as are appropriate:

- identification of which organizational entity prepared the document;
- information regarding the approval of the document;
- identification of other organizations that contributed to the preparation of the document;
- a statement of effectively identifying which other documents are cancelled and replaced in whole or in part;
- a statement of significant technical differences between this document and any previous document;
- the relationship of the document to other standards or documents.

I.7.5 Introduction

An introduction may be included to provide specific information or commentary about the technical content.

I.8 Content

I.8.1 Scope and applicability

This clause shall be numbered 1 and shall describe the scope, applicability and purpose of the analysis report.

I.8.1.1 Scope

This subclause shall be numbered 1.1 and shall contain the following statements:

“This analysis report contains the analysis results obtained for the [insert product and analysis identifier] of the [insert project identifier] project.

This analysis report is based on the requirements of the [insert AIV plan identifier].”

1.8.1.2 Purpose

This subclause shall be numbered 1.2 and shall contain the following statements:

“This analysis report provides evidence that the analysis required for the verification close-out of the relevant requirements has been performed.”

1.8.2 References

This clause shall be numbered 2 and shall contain the following subclauses.

1.8.2.1 Normative references

This subclause shall be numbered 2.1 and shall contain the following statements:

“This document incorporates, by dated or undated reference, provisions from other publications. These normative references are cited at appropriate places in the text and publications are listed hereafter. For dated references, subsequent amendments to or revisions of any of these apply to this document only when incorporated in it by amendment or revision. For undated references, the latest edition of the publication referred to applies.

[insert document identifier] [insert document title].”

Typically the reference documents are the product specification and the AIV plan.

1.8.2.2 Informative references

This subclause shall be numbered 2.2 and shall contain the following statement:

“The following documents, although not a part of this analysis report, amplify or clarify its contents:

[insert document identifier] [insert document title].”

1.8.3 Definitions and abbreviations

This clause shall be numbered 3 and shall contain the following subclauses.

1.8.3.1 Definitions

This subclause shall be numbered 3.1 and shall list any applicable project dictionary or glossary, and all unusual terms or terms with a meaning specific to the analysis report, with the definition for each term.

If a project dictionary or glossary is applicable, insert the following sentence:

“The definitions of [insert title and identifier of applicable dictionaries or glossaries] apply to this document.”

Insert the following sentence:

“The following terms and definitions are specific to this document:

[insert term] [insert definition].”

1.8.3.2 Abbreviations

This subclause shall be numbered 3.2 and shall list all abbreviations used in the analysis report with the full spelled-out meaning or phrase for each abbreviation.

1.8.4 Analysis approach

This clause shall be numbered 4 and shall summarize the analysis content and the method utilized.

1.8.5 Assumptions

This clause shall be numbered 5 and shall describe the basic assumptions, the boundary conditions and validity of the analysis.

1.8.6 Analysis technique description

This clause shall be numbered 6 and shall describe the analysis technique used including the software and associated models (if any).

1.8.7 Analysis results

This clause shall be numbered 7 and shall present the main calculations, associated results and accuracies (including sensitivity analysis if necessary).

1.8.8 Conclusions

This clause shall be numbered 8 and shall list the requirements to be verified (in correlation with the VCD) and shall summarize the analysis results, the comparison with the requirements and the verification close-out judgement.

The requirement close-out may be summarized in a dedicated format table to be prepared for each involved requirement or group of requirements (see Figures I-1 and I-2).

The definitions of the terms are in line with ECSS-10-02.

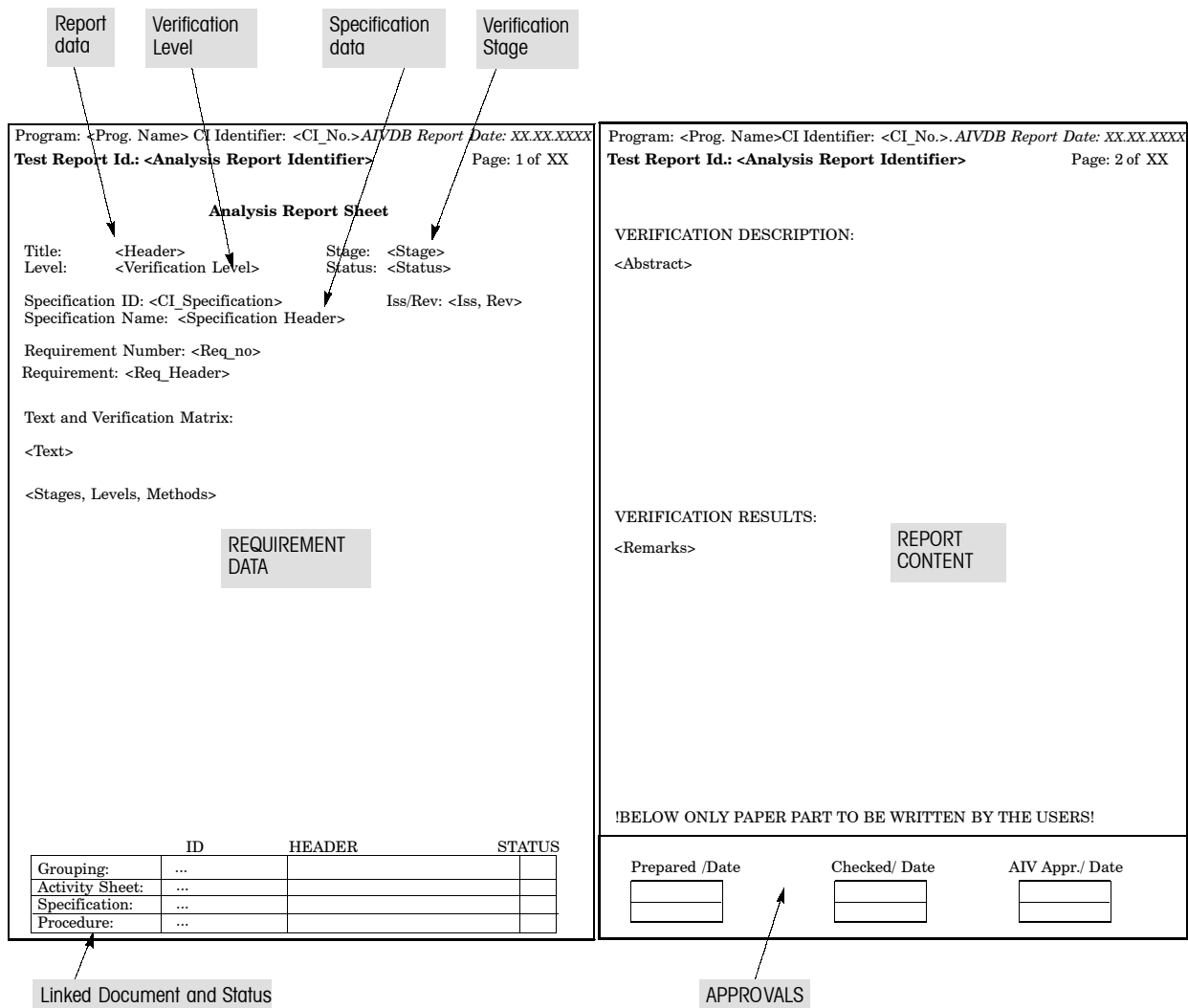

Figure I-1: Example of an analysis report sheet format

Program: SATELLITE CI Identifier: 1-000-1AIVDB Report Date: 01.12.1999
Test Report Id.: SAT-RP-001 Page: 1 of 2

Analysis Report Sheet

Title: Mass Budget Analysis Stage: QUALIFICATION
 Level: SYSTEM Status: Closed

Specification ID: SAT-SPEC-001 Iss/Rev: 1/-
 Specification Name: SATELLITE SYSTEM SPECIFICATION

Requirement Number: 4.1
 Requirement Header: Mass

Text and Verification Matrix:
 The Satellite System shall not exceed 2 t.

| Stage | SY | SS | EQ | - |
|------------|-----|----|----|---|
| QUAL | T.A | A | T | - |
| ACC | T | | T | - |
| PRE-LAUNCH | - | - | - | - |

| | ID | HEADER | STATUS |
|-----------------|----------|---------------|--------|
| Grouping: | G-MASS-A | Mass Analysis | C |
| Activity Sheet: | A-4.1.2 | Mass Analysis | C |
| Specification: | - | - | - |
| Procedure: | - | - | - |

Program: SATELLITE CI Identifier: 1-000-1AIVDB Report Date: 01.12.1999
Test Report Id.: SAT-RP-001 Page: 2 of 2

VERIFICATION DESCRIPTION:
 The Requirement has been verified by a mass budget analysis which evaluates the results at equipment level for the specified equipment level for the specified equipment and the test results at system level on the overall satellite in dry condition including the parts not covered by a dedicated specification.

VERIFICATION RESULTS:
 Requirement successfully verified. Dry satellite mas 1,5 t. Estimate overall satellite mass 1,98 t

| | | |
|---------------------------|--------------------------|------------------------------|
| Prepared /Date Mr. One | Checked/ Date Mr. Two | AIV Appr./ Date Mr. Three |
|---------------------------|--------------------------|------------------------------|

Figure I-2: Example of filled format

Annex J (normative)

Review-of-Design report - Document Requirements Definition (DRD)

J.1 Introduction

As required by ECSS-E-10-02, this document describes each verification activity performed for reviewing documentation.

It provides evidence that the relevant requirements have been verified and indicates any deviations.

J.2 Scope and applicability

J.2.1 Scope

This Document Requirements Definition (DRD) establishes the data content requirements for the Review-of-Design (ROD) report.

This DRD does not define format, presentation or delivery requirements for the ROD report.

J.2.2 Applicability

This DRD is applicable to all projects using the ECSS Standards.

J.3 References

J.3.1 Glossary and dictionary

This DRD uses terminology and definitions controlled by:

ECSS-P-001 Glossary of terms

ECSS-E-10-02 Space engineering - Verification

J.3.2 Source document

This DRD defines the data requirements of a ROD report as controlled by:

ECSS-E-10-02 Space engineering - Verification

J.4 Definitions, abbreviations and symbols

J.4.1 Definitions

For the purposes of this DRD the definitions given in ECSS-P-001 and in ECSS-E-10-02 apply.

J.4.2 Abbreviations

The following abbreviations are defined and used within this DRD.

| Abbreviation | Meaning |
|---------------------|--|
| ACC | Acceptance |
| AIV | Assembly, Integration and Verification |
| APPR | Approval |
| C | Closed |
| CI | Configuration Item |
| DRD | Document Requirements Definition |
| ECSS | European Cooperation for Space Standardization |
| EQ | Equipment |
| I | Inspection |
| I/F | Interface |
| ID | Identifier |
| N/A | Not applicable |
| PDR | Preliminary Design Review |
| QUAL | Qualification |
| REQ | Requirement |
| ROD | Review-of-Design |
| SS | Subsystem |
| SY | System |
| VCD | Verification Control Document |

J.4.3 Symbols

N/A

J.5 Description and purpose

The ROD report describes the execution and the results of the specific ROD activity.

It contains the summary of the activity and the conclusion.

Its principal use is to provide the customer with the evidence of satisfactory performance of review of design for verification close-out of the relevant requirements.

J.6 Application and interrelationship

The document is prepared for each verification level and for each ROD performed.

The ROD report may cover the activity relevant to the verification of several requirements in the case that the event is unique (for example ROD performed during a project design review).

It responds to the requirements contained in the relevant AIV Plan (DRD annex D) activity sheet.

It may be an input to a verification report (DRD annex L) in case of multi-method verification.

Its title page data (see subclause J.7.2) is recorded in the VCD (DRD annex E).

J.7 ROD report preliminary elements

J.7.1 Title

The document to be created based on this DRD shall be titled “[insert a descriptive modifier] Review-of-Design report”.

The descriptive modifier shall be selected to clearly identify the applicable product and type of ROD.

EXAMPLE “Satellite PDR Review-of-Design report”
“Pressurized module shuttle I/F Review-of-Design report ”

J.7.2 Title page

The title page shall identify the project document identification number, title of the document, date of release and release authority.

J.7.3 Contents list

The contents list shall identify the title and location of every clause and major subclause, figure, table and annex contained in the document.

J.7.4 Foreword

A foreword shall be included which describes as many of the following items as are appropriate:

- identification of which organizational entity prepared the document;
- information regarding the approval of the document;
- identification of other organizations that contributed to the preparation of the document;
- a statement of effectivity identifying which other documents are cancelled and replaced in whole or in part;
- a statement of significant technical differences between this document and any previous document;
- the relationship of the document to other standards or documents.

J.7.5 Introduction

An introduction may be included to provide specific information or commentary about the technical content.

J.8 Content

J.8.1 Scope and applicability

This clause shall be numbered 1 and shall describe the scope, applicability and purpose of the ROD report.

J.8.1.1 Scope

This subclause shall be numbered 1.1 and shall contain the following statements:

“This ROD report contains the ROD results obtained for the [insert product and ROD identifier] of the [insert project identifier] project.

This ROD report is based on the [insert AIV plan identifier] relevant activity sheet requirements.”

J.8.1.2 Purpose

This subclause shall be numbered 1.2 and shall contain the following statements:

“This ROD report provides evidence of satisfactory performance of ROD as a precursor to the verification close-out of the relevant requirements.”

J.8.2 References

This clause shall be numbered 2 and shall contain the following subclauses.

J.8.2.1 Normative references

This subclause shall be numbered 2.1 and shall contain the following statements:

“This document incorporates, by dated or undated reference, provisions from other publications. These normative references are cited at appropriate places in the text and publications are listed hereafter. For dated references, subsequent amendments to or revisions of any of these apply to this document only when incorporated in it by amendment or revision. For undated references, the latest edition of the publication referred to applies.

[insert document identifier] [insert document title].”

Typically the reference documents are the product specification and the AIV plan.

J.8.2.2 Informative references

This subclause shall be numbered 2.2 and shall contain the following statement:

“The following documents, although not a part of this ROD report, amplify or clarify its contents:

[insert document identifier] [insert document title].”

J.8.3 Definitions and abbreviations

This clause shall be numbered 3 and shall contain the following subclauses.

J.8.3.1 Definitions

This subclause shall be numbered 3.1 and shall list any applicable project dictionary or glossary, and all unusual terms or terms with a meaning specific to the ROD report, with the definition for each term.

If a project dictionary or glossary is applicable, insert the following sentence:

“The definitions of [insert title and identifier of applicable dictionaries or glossaries] apply to this document.”

Insert the following sentence:

“The following terms and definitions are specific to this document:

[insert term] [insert definition].”

J.8.3.2 Abbreviations

This subclause shall be numbered 3.2 and shall list all abbreviations used in the ROD report with the full spelled-out meaning or phrase for each abbreviation.

J.8.4 ROD summary

This clause shall be numbered 4 and shall describe the ROD activity in terms of method and procedures used.

J.8.5 Conclusions

This clause shall be numbered 5 and shall summarize the ROD results (i.e. list of the requirements to be verified (in correlation with the VCD), traceability to used documentation, conformance or deviation including proper references and signature/date), the comparison with the requirements and the verification close-out judgement.

The requirement close-out may be summarized in a format table to be prepared for each pertinent requirement or group of requirements (Figures J-1 and J-2).

The definitions of the terms are in line with ECSS-E-10-02.

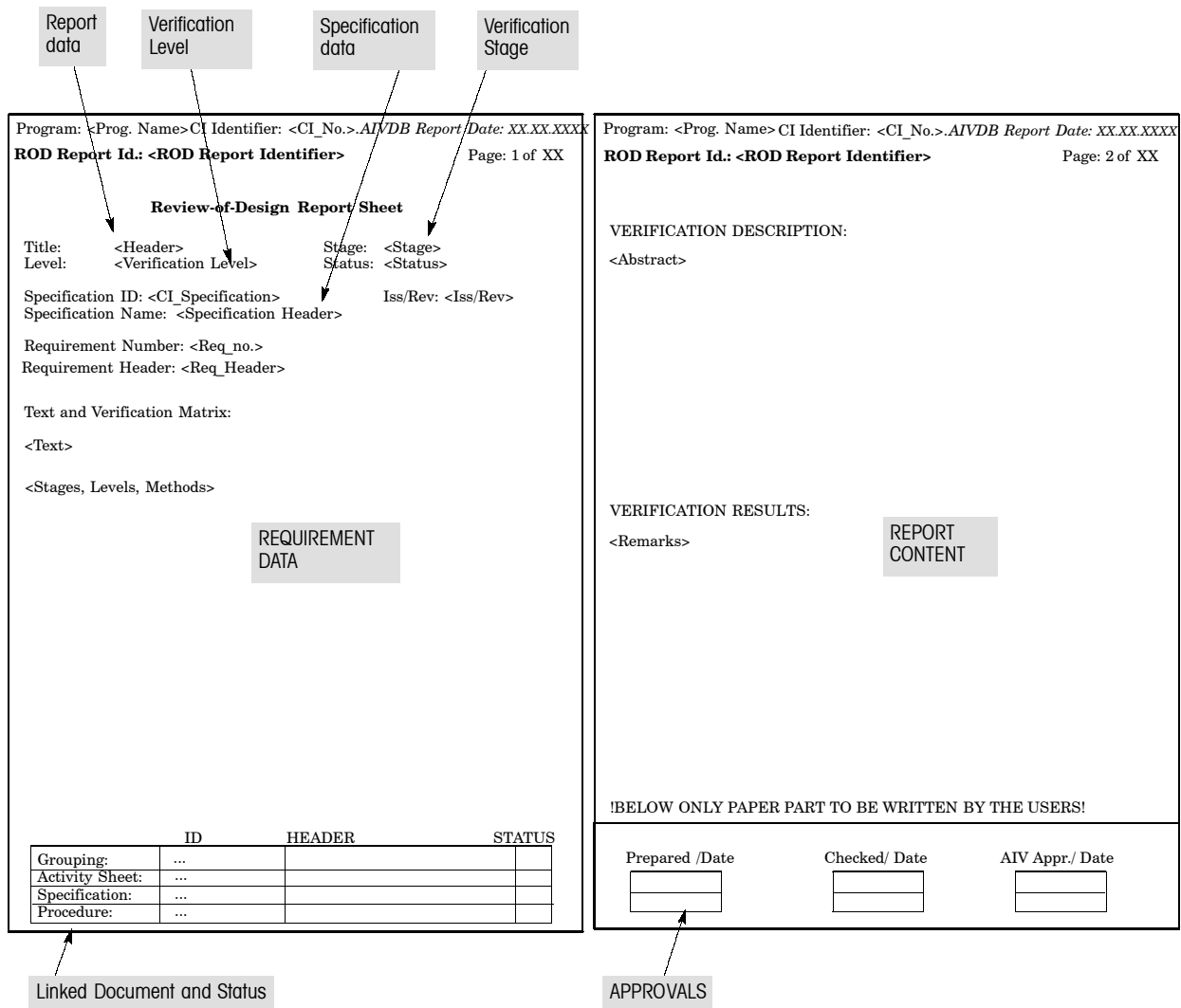

Figure J-1: Example of a Review-of-Design report sheet format

Program: SATELLITE CI Identifier: 1-000-1AIVDB Report Date: 01.12.1999
ROD Report Id.: SAT-RP-004 Page: 1 of 2

Review-of-Design Report Sheet

Title: Electrical Interface ROD Stage: QUALIFICATION
 Level: SYSTEM Status: Closed

Specification ID: SAT-SPEC-004 Iss/Rev: 1/-
 Specification Name: SATELLITE SYSTEM SPECIFICATION

Requirement Number: 4.2
 Requirement Header: Launcher Electrical Interfaces

Text and Verification Matrix:

The Satellite System Electrical Interfaces with the Launcher shall be in agreement with Fig. 4.2-1

| Stage | SY | SS | EQ | - |
|------------|-----|----|----|---|
| QUAL | I,R | A | I | |
| ACC | I | | I | |
| PRE-LAUNCH | I | | | |

| | ID | HEADER | STATUS |
|-----------------|----------|----------------------|--------|
| Grouping: | G-ELIF-R | Electrical Interface | C |
| Activity Sheet: | A-4.2.2 | Electrical Interface | C |
| Specification: | - | - | - |
| Procedure: | - | - | - |

Program: SATELLITE CI Identifier: 1-000-1AIVDB Report Date: 01.12.1999
ROD Report Id.: SAT-RP-001 Page: 2 of 2

VERIFICATION DESCRIPTION:

The Requirement has been verified by a suitable combination of ROD and Inspection activities at System Level based on ROD and Inspection results, respectively, at SS and Equipment levels. The Inspection is carried out on the umbilical connector and the ROD is performed on the interfaces DWG compared with Fig. 4.2-1

VERIFICATION RESULTS:

The Review of the connector Interface Drawing 0002 in comparison with the requirement of the Fig. 4.2-1 has been successfully performed. The Requirement is successfully verified.

| | | |
|----------------|---------------|-----------------|
| Prepared /Date | Checked/ Date | AIV Appr./ Date |
| Mr. One | Mr. Two | Mr. Three |

Figure J-2: Example of filled format

Annex K (normative)

Inspection report - Document Requirements Definition (DRD)

K.1 Introduction

As required by ECSS-E-10-02, this document describes each verification activity during hardware inspection.

It provides evidence that the relevant requirements have been verified and indicates any deviations.

K.2 Scope and applicability

K.2.1 Scope

This Document Requirements Definition (DRD) establishes the data content requirements for the inspection report.

This DRD does not define format, presentation or delivery requirements for the inspection report.

K.2.2 Applicability

This DRD is applicable to all projects using the ECSS Standards.

K.3 References

K.3.1 Glossary and dictionary

This DRD uses terminology and definitions controlled by:

ECSS-P-001 Glossary of terms

ECSS-E-10-02 Space engineering - Verification

K.3.2 Source document

This DRD defines the data requirements of an inspection report as controlled by:

ECSS-E-10-02 Space engineering - Verification

K.4 Definitions, abbreviations and symbols

K.4.1 Definitions

For the purposes of this DRD the definitions given in ECSS-P-001 and in ECSS-E-10-02 apply.

K.4.2 Abbreviations

The following abbreviations are defined and used within this DRD.

| Abbreviation | Meaning |
|---------------------|--|
| ACC | Acceptance |
| AIV | Assembly, Integration and Verification |
| APPR | Approval |
| C | Closed |
| CI | Configuration Item |
| DRD | Document Requirements Definition |
| ECSS | European Cooperation for Space Standardization |
| EQ | Equipment |
| FM | Flight Model |
| I | Inspection |
| I/F | Interface |
| ID | Identifier |
| N/A | Not applicable |
| QUAL | Qualification |
| REQ | Requirement |
| ROD | Review of Design |
| SS | Subsystem |
| SY | System |
| VCD | Verification Control Document |

K.4.3 Symbols

N/A

K.5 Description and purpose

The inspection report describes the execution and the results of the specific inspection activity.

It contains the summary of the activity and the conclusion.

The principal use is to provide the customer with the evidence of the performed inspection activity in verification close-out of the relevant requirements.

K.6 Application and interrelationship

The document is prepared for the different verification levels and for each inspection performed.

The inspection report may cover the activity relevant to the verification of several requirements in case that the event is unique (for example an inspection of several I/F requirements).

It is prepared on the basis of the requirements contained in the relevant AIV plan (DRD annex D) activity sheet.

It could be input to a verification report (DRD annex L) in case of multimethod verification.

Its title page data (see subclause K.7.2) is recorded in the VCD (DRD annex E).

K.7 Inspection report preliminary elements

K.7.1 Title

The document to be created based on this DRD shall be titled “[insert a descriptive modifier] inspection report”.

The descriptive modifier shall be selected to clearly identify the applicable product and type of Inspection.

EXAMPLE “Gyro (FM1) interface inspection report”
“Payload module straylight closure inspection report ”

K.7.2 Title page

The title page shall identify the project document identification number, title of the document, date of release and release authority.

K.7.3 Contents list

The contents list shall identify the title and location of every clause and major subclause, figure, table and annex contained in the document.

K.7.4 Foreword

A foreword shall be included which describes as many of the following items as are appropriate:

- identification of which organizational entity prepared the document;
- information regarding the approval of the document;
- identification of other organizations that contributed to the preparation of the document;
- a statement of effectivity identifying which other documents are cancelled and replaced in whole or in part;
- a statement of significant technical differences between this document and any previous document;
- the relationship of the document to other standards or documents.

K.7.5 Introduction

An introduction may be included to provide specific information or commentary about the technical content.

K.8 Content

K.8.1 Scope and applicability

This clause shall be numbered 1 and shall describe the scope, applicability and purpose of the inspection report.

K.8.1.1 Scope

This subclause shall be numbered 1.1 and shall contain the following statements:

“This inspection report contains the inspection results for the [insert product and Analysis identifier] of the [insert project identifier] project.

This inspection report is based on the relevant activity sheet requirements of the [insert AIV plan identifier].”

K.8.1.2 Purpose

This subclause shall be numbered 1.2 and contains the following statements:

“This inspection report provides evidence of the performance of the inspection activity required for the verification close-out of the relevant requirements.”

K.8.2 References

This clause shall be numbered 2 and shall contain the following subclauses.

K.8.2.1 Normative references

This subclause shall be numbered 2.1 and shall contain the following statements:

“This document incorporates, by dated or undated reference, provisions from other publications. These normative references are cited at appropriate places in the text and publications are listed hereafter. For dated references, subsequent amendments to or revisions of any of these apply to this document only when incorporated in it by amendment or revision. For undated references, the latest edition of the publication referred to applies.

[insert document identifier] [insert document title].”

Typically reference documents are the product specification and the AIV plan.

K.8.2.2 Informative references

This subclause shall be numbered 2.2 and shall contain the following statement:

“The following documents, although not a part of this inspection report, amplify or clarify its contents:

[insert document identifier] [insert document title].”

K.8.3 Definitions and abbreviations

This clause shall be numbered 3 and shall contain the following subclauses.

K.8.3.1 Definitions

This subclause shall be numbered 3.1 and shall list any applicable project dictionary or glossary, and all unusual terms or terms with a meaning specific to the inspection report, with the definition for each term.

If a project dictionary or glossary is applicable, insert the following sentence:

“The definitions of [insert title and identifier of applicable dictionaries or glossaries] apply to this document.”

Insert the following sentence:

“The following terms and definitions are specific to this document:

[insert term] [insert definition].”

K.8.3.2 Abbreviations

This subclause shall be numbered 3.2 and shall list all abbreviations used in the inspection report with the full spelled-out meaning or phrase for each abbreviation.

K.8.4 Inspection summary

This clause shall be numbered 4 and shall describe the inspection activity in terms of methods and procedures used.

K.8.5 Inspected item

This clause shall be numbered 5 and shall describe the product configuration data of the inspected item.

K.8.6 Conclusions

This clause shall be numbered 6 and shall summarize the inspection results (i.e. list of the requirements to be verified (in correlation with the VCD), traceability to used documentation, inspection event location and date, expected finding, conformance or deviation including proper references and signature/date), the comparison with the requirements and the verification close-out judgement.

The requirement close-out may be summarized in a separate table to be prepared for each pertinent requirement or group of requirements (Figures K-1 and K-2).

The definitions of the terms are in line with ECSS-E-10-02.

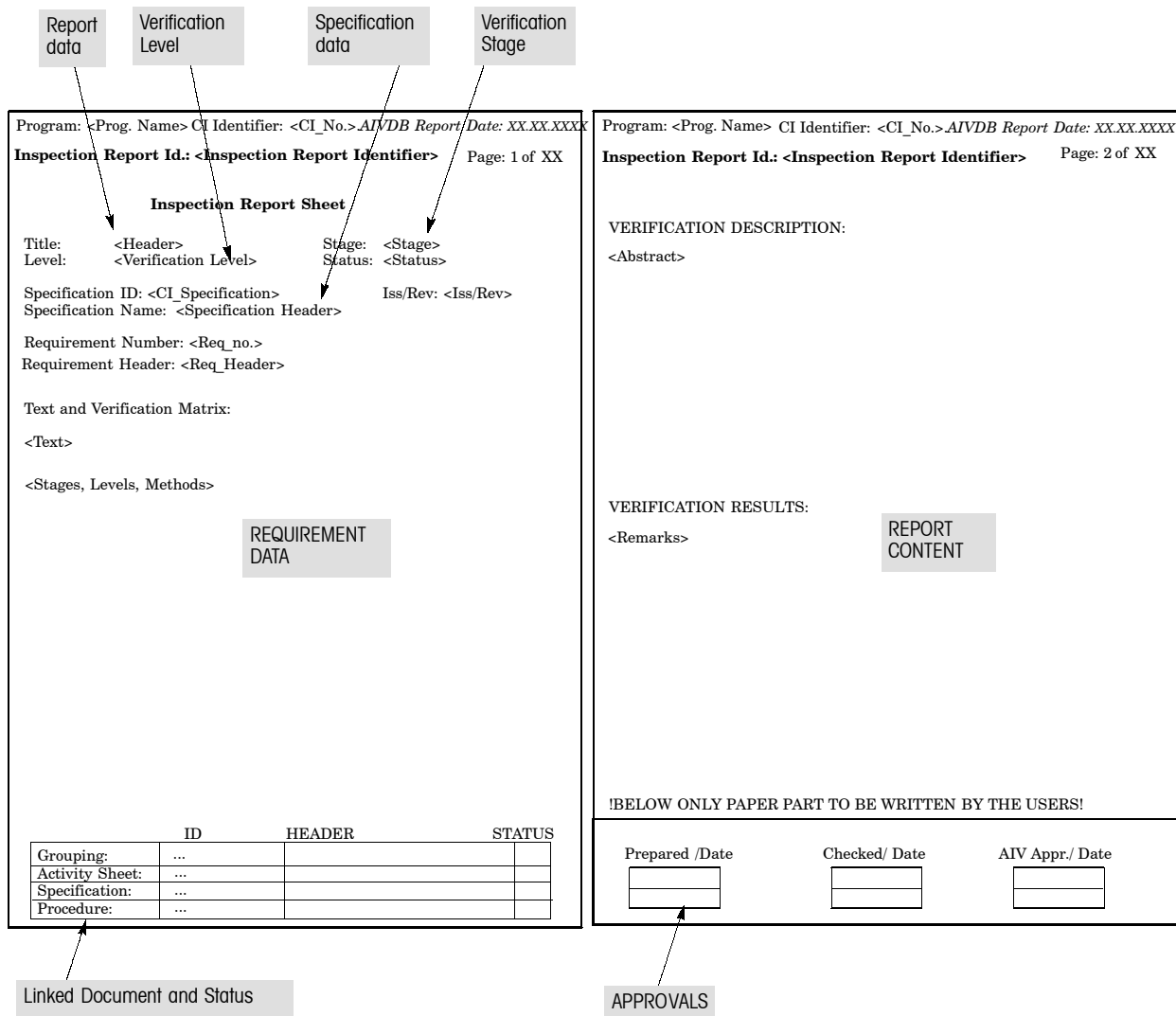

Figure K-1: Example of an inspection report sheet format



Program: SATELLITE CI Identifier: 1-000-1AIVDB Report Date: 01.12.1999
Inspection Report Id.: SAT-RP-003 Page: 1 of 2

Inspection Report Sheet

Title: Electrical Interface Inspection Stage: QUALIFICATION
 Level: SYSTEM Status: Closed

Specification ID: SAT-SPEC-001 Iss/Rev: 1/-
 Specification Name: SATELLITE SYSTEM SPECIFICATION

Requirement Number: 4.2
 Requirement Header: Launcher Electrical Interfaces

Text and Verification Matrix:

The Satellite System Electrical Interfaces with the Launcher shall be in agreement with Fig. 4.2-1

| | | | | |
|------------|-----|----|----|---|
| Stage | SY | SS | EQ | - |
| QUAL | I,R | A | I | - |
| ACC | I | | I | |
| PRE-LAUNCH | I | | | |

| | ID | HEADER | STATUS |
|-----------------|----------|----------------------|--------|
| Grouping: | G-ELIF-I | Electrical Interface | C |
| Activity Sheet: | A-4.2.2 | Electrical Interface | C |
| Specification: | - | - | - |
| Procedure: | - | - | - |

Program: SATELLITE CI Identifier: 1-000-1AIVDB Report Date: 01.12.1999
Inspection Report Id.: SAT-RP-003 Page: 2 of 2

VERIFICATION DESCRIPTION:

The Requirement has been verified by 1 of the interfaces defined in DWG which corresponds to Fig. 4.2-1 taking into account the ROD and Inspection Results obtained respectively at SS Equipment levels.

VERIFICATION RESULTS:

The Inspection of the Launcher Electrical Interface Umbilical Connector in comparison with Drawing 0002 has been successfully performed. The Requirement is fully verified.

| | | |
|----------------|---------------|-----------------|
| Prepared /Date | Checked/ Date | AIV Appr./ Date |
| Mr. One | Mr. Two | Mr. Three |

Figure K-2: Example of filled format

Annex L (normative)

Verification report - Document Requirements Definition (DRD)

L.1 Introduction

As required by ECSS-E-10-02, this document may be prepared in the case that more than one of the defined verification methods is utilized to verify a requirement or a specific set of requirements.

It explains the approach followed and how the verification methods were combined to achieve the verification objectives.

It contains proper evidence that the relevant requirements are verified and the indication of deviations.

L.2 Scope and applicability

L.2.1 Scope

This Document Requirements Definition (DRD) establishes the data content requirements for the verification report.

This DRD does not define format, presentation or delivery requirements for the verification report.

L.2.2 Applicability

This DRD is applicable to all projects using the ECSS Standards.

L.3 References

L.3.1 Glossary and dictionary

This DRD uses terminology and definitions controlled by:

ECSS-P-001 Glossary of terms

ECSS-E-10-02 Space engineering - Verification

L.3.2 Source document

This DRD defines the data requirements of a verification report as controlled by:

L.4 Definitions, abbreviations and symbols

L.4.1 Definitions

For the purposes of this DRD the definitions given in ECSS-P-001 and in ECSS-E-10-02 apply.

L.4.2 Abbreviations

The following abbreviations are defined and used within this DRD.

| Abbreviation | Meaning |
|---------------------|--|
| A | Analysis |
| AIV | Assembly, Integration and Verification |
| APPR | Approval |
| CI | Configuration Item |
| DRD | Document Requirements Definition |
| ECSS | European Cooperation for Space Standardization |
| ID | Identifier |
| N/A | Not applicable |
| REQ | Requirement |
| T | Test |
| VCD | Verification Control Document |

L.4.3 Symbols

N/A

L.5 Description and purpose

The verification report describes the execution and the results of a specific verification activity carried out with multiple methods.

It contains the description of the verification approach, the results of the different combined activities and the conclusions.

The principal use is to provide the customer with the evidence of the performed verification activities in verification close-out of the relevant requirements.

L.6 Application and interrelationship

The document is prepared for the different verification levels as necessary when verification with more than one method is involved.

The verification report may cover the verification of several requirements in case that the relevant verification events are the same (for example an environmental test and the associated analysis cover the same set of requirements).

It is prepared on the basis of the verification matrix (DRD annex C) and the associated AIV plan (DRD annex D), considering the results of the relevant test, analysis, Review-of-design and inspection reports (respectively DRD annexes H, I, J and K).

Its title page data (see subclause L.7.2) is recorded in the VCD (DRD annex E).

L.7 Verification report preliminary elements

L.7.1 Title

The document to be created based on this DRD shall be titled “[insert a descriptive modifier] verification report”.

The descriptive modifier shall be selected to clearly identify the applicable product and type of verification.

EXAMPLE “Primary structure dynamic verification report”
“Satellite accessibility verification report”

L.7.2 Title page

The title page for this document shall identify the project document identification number, title of the document, date of release and release authority.

L.7.3 Contents list

The contents list shall identify the title and location of every clause and major subclause, figure, table and annex contained in the document.

L.7.4 Foreword

A foreword shall be included which describes as many of the following items as are appropriate:

- identification of which organizational entity prepared the document;
- information regarding the approval of the document;
- identification of other organizations that contributed to the preparation of the document;
- a statement of effectivity identifying which other documents are cancelled and replaced in whole or in part;
- a statement of significant technical differences between this document and any previous document;
- the relationship of the document to other standards or documents.

L.7.5 Introduction

An introduction may be included to provide specific information or commentary about the technical content.

L.8 Content

L.8.1 Scope and applicability

This clause shall be numbered 1 and shall describe the scope, applicability and purpose of the verification report.

L.8.1.1 Scope

This subclause shall be numbered 1.1 and shall contain the following statements:

“This verification report contains the verification results for the [insert product and verification identifier] of the [insert project identifier] project.

This verification report is based on the following [insert the relevant test/analysis/Review-of-design/inspection reports identifier] reports.”

L.8.1.2 Purpose

This subclause shall be numbered 1.2 and shall contain the following statements:

“The verification report provides evidence of the satisfactory performance of the verification activities required for verification close-out of the relevant requirements.”

L.8.2 References

This clause shall be numbered 2 and shall contain the following subclauses.

L.8.2.1 Normative references

This subclause shall be numbered 2.1 and shall contain the following statements:

“This document incorporates, by dated or undated reference, provisions from other publications. These normative references are cited at appropriate places in the text and publications are listed hereafter. For dated references, subsequent amendments to or revisions of any of these apply to this document only when incorporated in it by amendment or revision. For undated references, the latest edition of the publication referred to applies.

[insert document identifier] [insert document title].”

Typically reference documents are the product specification, the verification matrix and the test/analysis/Review-of-design/inspection reports.

L.8.2.2 Informative references

This subclause shall be numbered 2.2 and shall contain the following statement:

“The following documents, although not a part of this verification report, amplify or clarify its contents:

[insert document identifier] [insert document title].”

L.8.3 Definitions and abbreviations

This clause shall be numbered 3 and shall contain the following subclauses.

L.8.3.1 Definitions

This subclause shall be numbered 3.1 and shall list any applicable project dictionary or glossary, and all unusual terms or terms with a meaning specific to the verification report, with the definition for each term.

If a project dictionary or glossary is applicable, insert the following sentence:

“The definitions of [insert title and identifier of applicable dictionaries or glossaries] apply to this document.”

Insert the following sentence:

“The following terms and definitions are specific to this document:

[insert term] [insert definition].”

L.8.3.2 Abbreviations

This subclause shall be numbered 3.2 and shall list all abbreviations used in the verification report with the full spelled-out meaning or phrase for each abbreviation.

L.8.4 Verification results

This clause shall be numbered 4 and shall describe the verification approach, the associated problems and results with reference to the relevant test/analysis/Review-of-design/inspection reports.

L.8.5 Conclusions

This clause shall be numbered 5 and shall list the requirements to be verified (in correlation with the VCD) and shall summarize verification results, the comparison with the requirements and the verification close-out judgement.

The requirement close-out may be summarized in a separate table to be prepared for each pertinent requirement or group of requirements (see Figures L-1 and L-2).

The definitions of the terms are in line with ECSS-E-10-02.

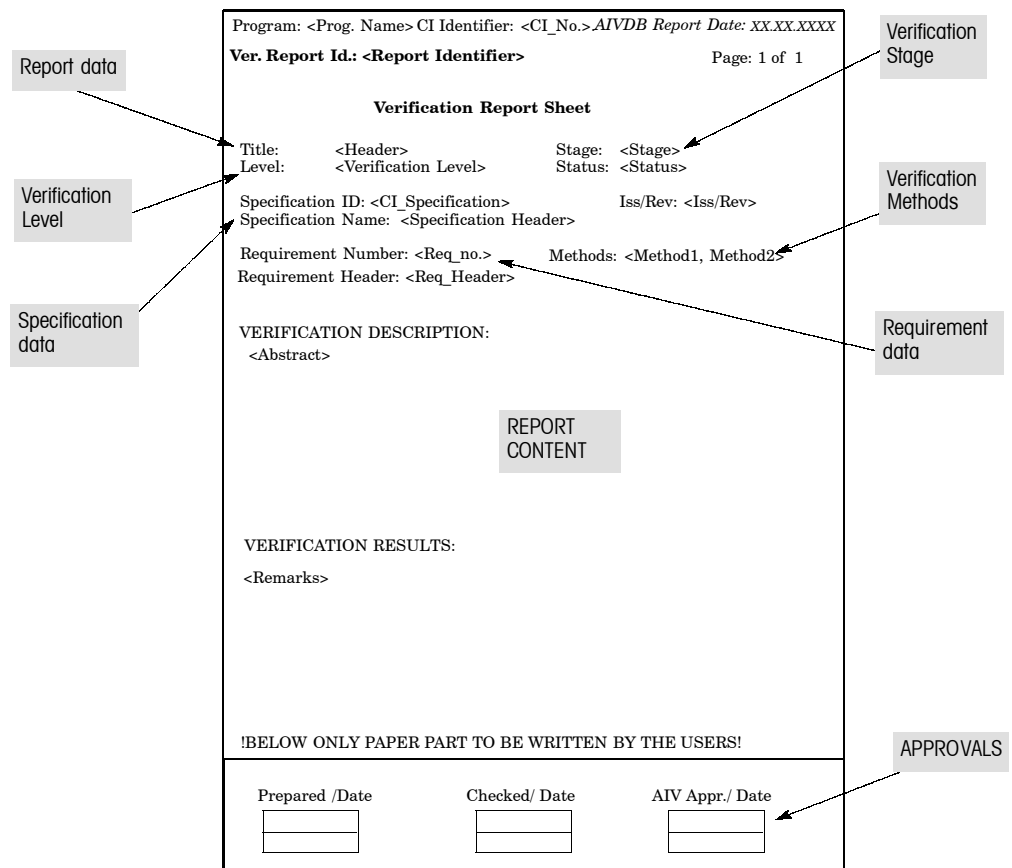

Figure L-1: Example of a verification report sheet format

| | | | | | |
|---|---------------|--|---------|--|-----------|
| Program: SATELLITE CI Identifier: 1-001-01AIVDB Report Date: 20/12/1998 | | | | | |
| Ver. Report Id.: sat-rp-006 | | Page: 1 of 1 | | | |
| Verification Report Sheet | | | | | |
| Title: | MASS | Stage: QUALIFICATION | | | |
| Level: | System | Status: Closed | | | |
| Specification ID: | SAT-SPEC-001 | Iss/Rev: 1/- | | | |
| Specification Name: Satellite System Specification | | | | | |
| Requirement Number: | 4.1 | Methods: T, A | | | |
| Requirement Header: Mass | | | | | |
| | | | | | |
| VERIFICATION DESCRIPTION: | | | | | |
| The requirement has been verified at system level by means of a combination of Test and Analysis as described in the attached Test and Analysis Report Sheets (included in the respective reports: SAT-RP-001 and SAT-RP-002) | | | | | |
| | | | | | |
| VERIFICATION RESULTS: | | | | | |
| The Verification has been successfully completed, dry satellite mass 1,5 Tons, estimated overall satellite mass through analysis 1,9 Tons. | | | | | |
| | | | | | |
| !BELOW ONLY PAPER PART TO BE WRITTEN BY THE USERS! | | | | | |
| Prepared /Date | Checked/ Date | AIV Appr./ Date | | | |
| <table border="1" style="width: 100%; height: 20px;"> <tr><td style="text-align: center;">Mr. One</td></tr> </table> | Mr. One | <table border="1" style="width: 100%; height: 20px;"> <tr><td style="text-align: center;">Mr. Two</td></tr> </table> | Mr. Two | <table border="1" style="width: 100%; height: 20px;"> <tr><td style="text-align: center;">Mr. Three</td></tr> </table> | Mr. Three |
| Mr. One | | | | | |
| Mr. Two | | | | | |
| Mr. Three | | | | | |

Figure L-2: Example of filled format

(This page is intentionally left blank)